

RELAYS

ENERGY | RAILWAY SERIES

AMRA and MTI Lines



The following catalogues are also available



RAILWAY series, fixed equipment catalogue - RFI approved relays

Relays and products for railway fixed equipment systems, approved under and compliant with reference specification **RFI DPRIM STF TE 143 A** (Rete Ferroviaria Italiana, Italian National Railway), designed for use in power and electrical traction systems

- Protection, control and monitoring systems for AC/DC conversion stations
- Line disconnect control panels
- Supervision of line voltage presence
- PPF power supply systems
- Trip relays
- Power supply systems for railway signalling equipment



LV15 - LV16 - LV20 series catalogues - ENEL / TERNA approved relays

Relays and products for electricity production, transmission and distribution systems, approved under and compliant with reference specifications **LV15, LV16, LV20**, designed for use in control, protection, monitoring and automation systems

- Protection, control and monitoring systems for HV electricity distribution stations
- Protection, control and monitoring systems for electricity generating stations
- Turbine, alternator and transformer automation systems
- Monitoring and control systems for reservoirs, dams, valves
- Trip relays



Introduction

Company, quality, products	4
Applications	6
The electromechanical relay, definition parameters	8

Selection guide, Ordering scheme, Options

Relay selection guide	14
Socket selection guide	16
Ordering scheme	18
Options	19

AMRA Line



1.1 POK Series: POKS, BIPOKS, TRIPOKS, QUADRIPOKS, ESAPOKS	23
1.2 OK Series: OK, OKS, OKFC, OKSFC, OKSCd, OKSGCd, OKUIC	29
1.3 RV Series: RVLV16/1, 2, 3, 5	39
1.4 OKBA Series	43
1.5 TM Series: TMS2E, TMS2R, TMS4E, TMS4R	49
1.6 TOK, OKTf Series	55
1.7 OKT, OKR Series: OKTa, OKTr, OKRe, OKRr	61
1.8 UTM Series	67
1.9 MOK Series: MOK-V2	71
1.10 OKPh, MOK-Ph2 Series	75
1.11 TOK-L, OKRe-L, TOK-FP, OKRe-FP, CLE Series	79

MTI Line



2.1 RCM, RDM Series	89
2.2 RGM Series	93
2.3 RGG Series with forcibly guided contacts	97
2.4 RMM Series	101
2.5 RGB Series	105
2.6 RMB Series	109
2.7 RMN, RMD Series	113
2.8 RGR, RGMV, RMMZ, RMMV Series, fast-acting monostable	119
2.9 RGBZ10-11, RMBZ30 Series, fast-acting bistable	123
2.10 RDT Series	127
2.11 RDL, RGL Series	133
2.12 RDTE15-16, RGTO Series	137
2.13 TD Series	141

Mounting accessories



3.1 - 3.6 Sockets for AMRA line	148
3.7 - 3.14 Sockets for MTI line	158
3.15 AMRA line Numbering correspondence between Relay and Socket	170
3.16 Retaining clips	171
3.17 Positive mechanical keying (polarizing pins)	172





INTRODUCTION

- Company, products
- Applications
- The electromechanical relay

◆ COMPANY

AMRA S.p.A., founded in 1975, is a company of the **CHAUVIN ARNOUX Group**, the leading name for measurement instrumentation used in a variety of sectors: electrical, industrial, tertiary and environmental.

Incorporated for the purpose of manufacturing electromechanical relays under licence from the group and associated originally with the OK product line, AMRA has established an increasingly strong reputation for the quality of its products, becoming an approved supplier to the main providers of electricity and to international EPC (Engineering, Procurement and Construction) services, also to the leading builders of rolling stock, and rail operators.

In December 1999 AMRA S.p.A. absorbed the company **MTI s.r.l.**, a manufacturer of relays since 1957. Combining their synergies, the two companies proceeded to strengthen and stimulate growth in the market of interest, as they sought to supply a range of products offering higher and higher quality, backed up by a better service, with the end in view of maximizing customer satisfaction.

Founded in 1893 by Raphaël CHAUVIN and René ARNOUX, the **CHAUVIN ARNOUX Group** is an industrial organization that today offers a comprehensive range of products for measuring, controlling and supervising electrical power grids and energy systems.



AMRA S.p.A. - Macherio (MB)

Having totally mastered the conception and in-house manufacture of these products, the group is able to keep innovating and offering its customers a notably wide range of products and services that respond to every need.

◆ QUALITY

Known for the high quality of its products, AMRA was among **the first Italian companies to obtain certification** of its Quality System, in 1993. The current certification, to **ISO9001**, therefore represents a guarantee of steady commitment on the part of the company to show that it can provide a product that will satisfy any given set of requirements, ensure continual improvement, and monitor customer satisfaction. Modern quality control equipment and a particularly stringent testing procedure (100% of items checked) enable the company to provide the customer with a product of high quality and reliability.

Thanks to extensive experience and continuously evolving research on organic materials, backed up by specific tests in the areas of reaction to fire, long-term stability and the ability

to withstand shock and vibration, our company has made its name on the market as a supplier capable of responding to the various needs of the energy and rail sectors.



◆ PRODUCTS

Relays of the **AMRA** line and **MTI** line provide customers with a wide range of solutions, from relays with 2 change-over contacts to multipole models with 20 change-over contacts, also monostable, bistable and timer relays, and special models. Part of the company's activity is dedicated to the development and manufacture of components suitable for rail-tram-trolley applications (on board trains) and rail transport (power systems and electrical traction).

Collaboration with the engineering departments of leading companies in the sector has also made it possible to create and manufacture products suitable for specific applications, designed especially to guarantee maximum reliability, durability and safety in operation.



◆ 2 LINES OF RELAYS: AMRA and MTI

The AMRA and MTI product lines offer common features in terms of performance, reliability and durability. They fill roles that call for a high level of responsibility, even in severe operating conditions.

When selecting the line of relays to utilize, the customer must make a correct assessment of the operating specifications and the environmental and operating constraints under which the relays are required to perform.

The AMRA line features products of superior mechanical design manufactured using carefully selected plastics and metals, which offer high resistance to shock and vibration and comply with the most stringent regulations on the fire reaction of organic materials. This makes them suitable for use in heavy duty sectors, including rail-tram-trolley

applications and on-board equipment for rolling stock.

AMRA relays are especially suitable for applications subject to strong fluctuations in supply voltage and sharp variations in ambient temperature.

The MTI line, characterized by flexibility in conception and modular design (relays with up to 20 change-over contacts, in both monostable and bistable version), covers numerous applications in power generation, transmission and distribution, and in the shipbuilding and petrochemical sectors.

Equipped with contacts of special geometry, these relays are able to break strongly inductive loads at high DC voltages (220V and above), while at the same time handling low current signals typical of those used for monitoring the status of the relay.



AMRA line



MTI line

◆ APPLICATIONS

Marketed under the **AMRA**, **CHAUVIN ARNOUX** and **ENERDIS** brands, our products have become a “must” for the most demanding of sectors and applications, typically the production, transmission and distribution of electrical energy, water treatment and purification, also the petrochemical, and mining industries, merchant shipbuilding and railways (rolling stock and infrastructure). There is one requirement common to all these applications: continuity of service. A system stoppage can often result in serious inconvenience to the public, loss of income, and loss of image. The aim of the designer is to select components of proven reliability and durability, with high operational responsibility.

POWER SYSTEMS, AC/DC CONVERSION AND ELECTRIC RAIL TRACTION



- Protection, control and monitoring systems for AC/DC conversion stations
- Line disconnect control panels
- Supervision of line voltage presence
- PPF power supply systems
- Trip relays
- Railway signalling power supply systems



RAILWAY EQUIPMENT

PETROCHEMICAL AND CHEMICAL INDUSTRY, SHIPBUILDING INDUSTRY, HEAVY INDUSTRY



- Protection, control and monitoring systems for energy transformation and conversion
- Instrumentation panels and automation of manufacturing processes
- Medium voltage distribution panels
- Motor Control Centre (MCC) electrical panels



PETROLEUM INDUSTRY



SHIPBUILDING



HEAVY INDUSTRY

Look for the application symbol to identify the right product more easily.



Pet



Power generation



Power transmission



Rolling stock



Railway equipment



Shipbuilding



Petroleum industry



Heavy industry

ROLLING STOCK

- Door control
- Brake systems
- Safety loops
- Pantograph control
- Lighting and air-conditioning control
- Battery charge monitoring
- Traction systems
- Vehicle safe-running control systems (ERT, MS, SCMT, ATS, etc.)



ROLLING STOCK



PRODUCTION, TRANSMISSION AND DISTRIBUTION OF ENERGY

- Protection, control and monitoring systems for HV distribution stations
- Protection, control and monitoring systems for electricity generating stations
- Turbine, alternator and transformer automation systems
- Monitoring and control systems for reservoirs, dams, valves
- Trip relays



POWER GENERATION



POWER DISTRIBUTION



Main parameters for definition of electromechanical relay

TYPES

Electromechanical relays are classifiable in 2 main types: all-or-nothing, and measuring.

- **ALL-OR-NOTHING RELAY** → A relay designed to respond to an electrical input of which the value falls within its operating range, or is equal to zero. The status of the output contacts does not depend on the passage of the electrical input for a specified operating value.
- **MEASURING RELAY** → A relay of which the operation is associated with a nominal voltage to a specified level of precision.

In the case of All-or-Nothing relays, a distinction is made between:

- **MONOSTABLE** relays → Relays in which the status of the contacts depends on the presence or absence of power at the coil terminals; when the coil is powered up, the contacts change position. As soon as the coil is powered down, the contacts return to their initial position.
- **BISTABLE** relays → Relays with 2 stable states. A bistable relay is generally equipped with 2 coils mounted in opposition. The contacts change status in response to an electrical impulse provided by one of the 2 coils, and are held in position by means of a magnetic or mechanical latch even in the event of the power supply being cut off. To return the contacts to their initial position, the other coil must be powered up.

Monostable relays can be divided into:

- **INSTANTANEOUS MONOSTABLE** → Relays in which the switching of the contacts occurs simultaneously with the change in status of the coil (powered up/down).
- **TIME DELAY MONOSTABLE** → Relays in which the switching of the contacts can be delayed by a preset duration, relative to the change in status of the coil (powered up/down).

The main types of time delay relay are:

- **On pick-up:** when the relay is powered up, the contacts will be switched only after a set period of time "T" (fixed or adjustable). As soon as the relay is deprived of electrical power, the contacts return instantaneously to their initial position.
- **On drop-out:** when the relay is powered up, the contacts are switched instantaneously. When the coil is powered down, the contacts return to their initial position after a set period of time "T" (fixed or adjustable). Normally, this type of relay requires an auxiliary power input to guarantee that the coil remains energized during the time delay; in this instance the relay will be furnished with a "control" input determining the start of the time delay period.

RELAYS WITH FORCIBLY GUIDED (MECHANICALLY LINKED) CONTACTS

In relays with forcibly guided (mechanically linked) contacts, special design and constructional measures are used to ensure that make (normally-open) contacts can not assume the same state as break (normally-closed) contacts.

- Should an NC contact fail to open when the relay is energized, the remaining NO contacts must not close, maintaining a gap of ≥ 0.5 mm between open parts
- Should an NO contact fail to open when the relay is de-energized, the remaining NC contacts must not close, maintaining a gap of ≥ 0.5 mm between open parts

EN50205 lays down the standard requirements for relays with forcibly guided contacts. This standard defines two types of relay with forcibly guided contacts, namely

- Type A: Relay whose contacts are all mechanically linked (forcibly guided)
- Type B: Relay containing mechanically linked contacts and contacts which are not mechanically linked.

In the case of relays that include changeover contacts, either the make circuit or the break circuit of a changeover contact can be considered to meet the requirements of this standard.

Relays responding to **EN50205** standard can be used in automatically controlled systems, for example safety-related monitoring systems.

AMRA relays of the RGG line are type A devices.

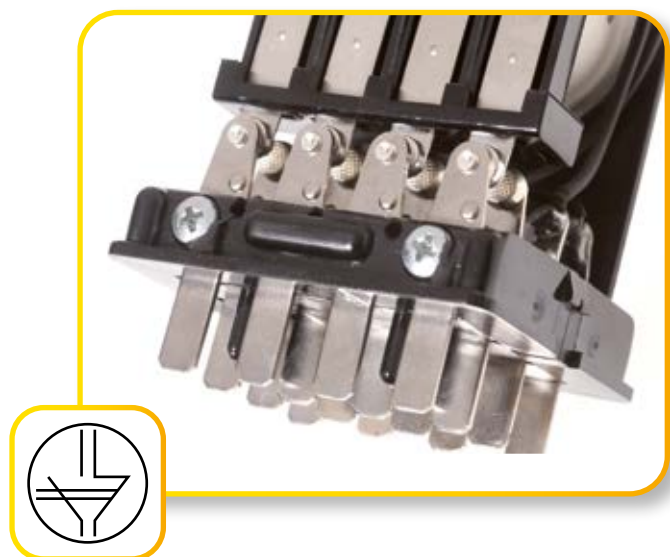

POWER SUPPLY

The power supply used by relays is characterized by a number of factors, and principally:

- **NOMINAL VOLTAGE** (V_n) or **NOMINAL CURRENT** (I_n) → The voltage or current (in the case of current monitoring relays) for which the coil of the relay is sized
- **OPERATING RANGE** → The voltage range within which the relay functions correctly, expressed usually as a percentage of the nominal voltage
- **CONSUMPTION** → Power drawn by the relay during

operation (declared at V_n)

- **DROP-OUT VOLTAGE** → Standard value (expressed as percentage of nominal voltage) defining the voltage at which drop-out/de-energization of the relay is certain to occur. Beneath this value, the monostable relay is certain to be returned to break status.

Some applications require particularly wide operating ranges, for example 70% ... 1.25% U_n in the case of electromechanical components used on rolling stock.

PROTECTION DEVICES

For relays operated off DC voltage, when the power supply is discontinued, energy stored in the coil inductance creates an electromotive force contrary to that of the power supply. This stray voltage can reach values measured in thousands of volts. In this situation it is possible to install voltage suppression components connected appropriately to the coil of the relay, such as the **FLYBACK DIODE**, the **VARISTOR** or the **TRANSIL**.

The **Diode** is the suppression component most widely adopted. This component provides a very low recirculation resistance for the energy accumulated at the leads of the coil and therefore offers the highest level of suppression available. The time needed for the depletion of this energy is considerable, and the time taken to de-energize by a relay with a diode wired in parallel to the coil increases by 2 to 5 times the nominal value.

The **Transil** component provides a better method of suppression.

More exactly, the EMF peak generated by the coil is limited to the Transil breakdown voltage. The breakdown voltage is selected consciously: it is greater than the maximum voltage applicable to the coil, allowing a margin of safety.

The increase in de-energization time that occurs when using this component is negligible.

The Transil suppressor also serves to protect electronic circuits from extremely rapid and destructive peak overvoltages. In effect, the response time of this component is ultra fast (often in the order of picoseconds).



There are two types of Transil suppressor:

- Unidirectional Transils: these block disturbances in one direction only, whereas in the presence of voltages with opposite polarity they respond as normal diodes.
- Bidirectional Transils: these are installed in circuits where an alternating voltage is present; they consist of two Transil diodes connected in anti-series.

The **varistor** is a variable resistor, of which the resistance value depends on the applied voltage. The operating graph is very similar to that of the Transil. Unlike a diode, the varistor is not a polarized component, which means that it can be utilized wherever there is a need for non-polarized relays, or when protection is required for AC applications. One characterizing feature of the varistor is that it has a clamping voltage higher than that of a standard diode.

CONTACTS – TYPE

Loads are controlled by mechanical contacts having different specifications according to the model of relay selected; a contact can be:

SYMBOL	DEFINITION	ACRONYM
	Normally open (NO)	SPST-NO Single Pole Single Throw, normally open
	Normally closed (NC)	SPST-NC Single Pole Single Throw, normally closed
	Change-over	SPDT Single Pole Double Throw

Change-over contacts can be divided into two categories: "Form C" or "Form D".

- "Form C": this operates on the principle of **Break Before Make (BBM)**. When the coil is energized, the COM (common) pole first breaks electrical continuity with the NC (normally closed) pole, then establishes electrical continuity with the NO (normally open) pole.
- "Form D": this operates on the principle of **Make Before Break (MBB)**. When the coil is energized, the COM (common) pole first establishes electrical continuity with the NO (normally open) pole, then breaks electrical continuity with the NC (normally closed) pole.

AMRA relays are equipped with "Form C" contacts, and available in versions with 2 to 20 contacts.

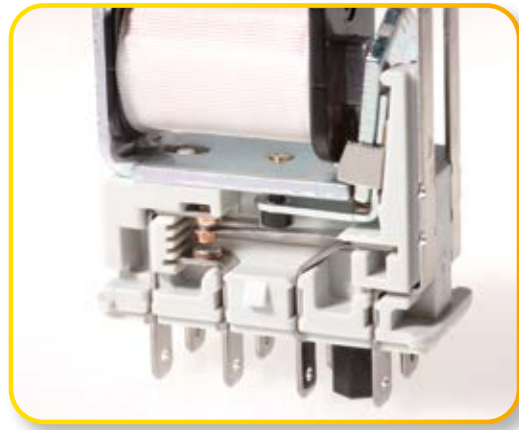

CONTACTS - LOAD

Depending on the type of load circuit to be broken / made / driven, contacts can be specified with different materials or finishes, and mounted in conjunction with a magnetic blow-out function that helps to extinguish the electric arc generated by the electrical load to which the relay is connected. It is important to take note of the difference between the **NOMINAL CURRENT (RANGE)** of the contact and its **BREAKING CAPACITY**:

- **RANGE** → The current that can flow through a contact for an indefinite period of time without the contact suffering damage.

- Depending on its specific attributes, the relay can break high or low power loads. The **BREAKING CAPACITY**, expressed in amperes, is the maximum level of current that can be broken by the particular relay under **SPECIFIC CONDITIONS**.

There are multiple parameters involved:

- voltage (V) at the contact
- type of load (DC or AC)
- nature of load, i.e. resistive or inductive.

The inductive load is defined by

- if DC: time constant L/R, expressed in ms (for resistive loads = 0ms)
- if AC: $\cos\phi$ (for resistive loads = 1)

- number of operations per hour

Determining these parameters, it is possible to establish the **ELECTRICAL LIFE EXPECTANCY** of the contact/relay.

Like any other mechanical component, the contacts of relays are subject to wear; depending on the type of use envisaged, the manufacturer indicates an electrical life expectancy and a mechanical life expectancy.

- **ELECTRICAL LIFE EXPECTANCY** → The number of successful operations that can be accomplished by a contact, breaking or making a given load circuit at a selected hourly frequency, with no impairment of characteristics designed to ensure correct operation.

- **MECHANICAL LIFE EXPECTANCY** → The number of successful operations that can be accomplished by a contact under no-load conditions (no electrical load) at a selected hourly frequency, with no impairment of characteristics designed to ensure correct operation of the relay.

The mechanical or electrical life expectancy parameter is conditional on the electrical load. Where the load applied to the contacts is notably small, the maximum electrical life expectancy will approach the duration of the mechanical life expectancy.

The capacity of a contact to control and handle loads of greater or lesser strength depends on various aspects of design and manufacture, such as the material from which the contact is made, the application of surface treatments if any, such as gold-plating, also distance between contacts, inclusion of magnetic arc blow-out, pressure between contacts, and the adoption of arc cut-off chambers.

- **GOLD-PLATING of CONTACT**: has the effect of lowering surface resistance and enabling the conduction of lower currents than would be possible with an untreated contact.
- **MAGNETIC ARC BLOW-OUT**: allows an electric arc to be extinguished more swiftly, and consequently increases **BREAKING CAPACITY**.

Before selecting the relay and the type of contact, accordingly, one of the priorities is to determine the **ELECTRICAL LOAD** and the type of duty required from the relay:

- load category (e.g. motor, coil, lamps, etc.)
- voltage (V) and type (DC or AC) of load
- current in circuit to be made and/or broken
- characteristics of the load, i.e. time constant L/R (if DC) or $\cos\phi$ (if AC)
- number of operations per hour
- required electrical life expectancy

AMRA staff are always at the disposal of customers to advise on selection.



POK relay with gold-plated contacts and terminals, and tropicalized coil

ELECTRICAL LOAD

A resistive load powered by an AC voltage is the most favourable condition for a contact: with the voltage passing through zero, any formation of electric arcs is suppressed. Also, there are no accumulated energies of an inductive or capacitive nature involved, which would tend to favour the formation of electric arcs on the contacts.

Breaking loads powered by a DC voltage is less simple. With a DC voltage, the current does not pass through zero: this means that any electric arc that may be struck between open elements of the contact will take longer to extinguish, and consequently the surface of the contact is more readily degraded. Hence, **ELECTRICAL LIFE EXPECTANCY** is reduced.

The strength of the electric arc may be more or less pronounced depending on the $\cos\phi$ (AC) and the time constant L/R (DC) of the load.

The time constant is the ratio between the inductance L and the resistance R of a load. In the case of DC loads, the most favourable operating condition is with a resistive load, as the time constant L/R will be equal to 0 (ms).

With an inductive load, electrical life expectancy is notably reduced as the value of the time constant L/R increases.

On breaking the load, a high time constant corresponds to a high level of energy stored by the inductance, which is returned to the circuit at the moment when the break is made, in the form of a reverse polarity voltage peak. The time constant of coils operating contactors, circuit breakers or similar devices can be anything up to 40-50 ms.

The inclusion of a magnetic arc blow-out may be indispensable, as it provides a particular guarantee of efficiency when breaking direct current loads, helping as it does to extinguish the arc, as the arc itself is extended.

On the basis of the distance between the NO and NC contacts and the type of calibration/sizing of the relay components, a given response time will be needed for the relay to complete an operation; depending on the status of the coil (energized/de-energized), consideration must be given to:

- **OPERATING TIME** → the time required for stable closure of an NO or NC contact when the coil is energized/de-energized (generally inclusive of bounces, if any).
- **BOUNCE TIME** → the time elapsing between the initial closure of an NO or NC contact and the moment when the position of the contact stabilizes (generally included in the operating time).

APPLICATIONS - ENVIRONMENTAL AND OPERATING CONSTRAINTS

To ensure the correct choice of relay for a given situation, any environmental and operating constraints under which the relay will be used must first be correctly interpreted.

Depending on the application for which it is selected, any relay may be exposed to various environmental stresses which, if not properly evaluated, may prevent the product from operating correctly and accelerate its degradation exponentially. The factors to take in consideration for a correct analysis are:

- **OPERATING TEMPERATURE** range → The ambient temperature at which the relay is required to operate. In the event of conditions being variable, worst case minimum and maximum values must be considered
- **RELATIVE HUMIDITY** → Percentage value indicating the level of ambient humidity; for values higher than 75% and up to 95%, selection of a relay with tropicalized coil is advisable.

APPLICATIONS: RAIL, TRAM, TROLLEY and METRO

In the case of transport applications (rail, tram, trolley and metro), consideration must be given to pertinent regulations governing the sector in question, which will normally specify operating constraints more stringent than those of standard product regulations. Harmonized European and Extra-European standards tend to regulate the following parameters (those indicated here are the main parameters applicable to relays):

- **RESISTANCE TO SHOCK AND VIBRATION:** these can damage the component or cause contacts to open spontaneously. Tests are designed to verify the capacity of the product to withstand the vibration conditions in the type of environment to which railway rolling stock will normally be exposed.
- **REACTION TO FIRE:** the specified requirements are intended to protect passengers and crew in the event of fire breaking out on board. Tests are designed to verify the self-extinguishing capacity of organic materials and

the level of toxicity and opacity in smoke and fumes generated by combustion. The level of severity can vary according to the type of application (for example, in the case of METRO applications, the criteria adopted are more stringent than for TRAM applications).

- **OPERATING RANGE:** the operating range is wider than indicated normally for standard electromechanical components, as relays can also be battery-powered (wide range of vehicle voltages).
- **OPERATING TEMPERATURE:** given the operating conditions typical of the applications mentioned above, the temperature range will normally be wider than that indicated by industry standards.

AMRA relays for rail, tram, trolley and metro applications are designed to meet the requirements of different sector-specific regulations and standards. For details, consult the technical documentation for the product.

Our relays are designed to last for the entire life cycle of a train



APPLICATIONS: ELECTRICAL ENERGY PRODUCTION

Electricity generating stations are complex environments. The loads supervised by control systems often use DC voltages, as in the case of solenoids or valves: relay contacts must be of a type suitable for switching these loads. Thermoelectric, hydroelectric and wind turbines are required to withstand heavy duty and non-stop operating conditions: particularly complex demands in terms of guaranteeing continuity of service and long-term dependability. In the case of hydroelectric and wind power generating facilities located in places where access is difficult (mountains or offshore platforms), maintenance costs tend to be high. Particular care must be taken where there are significant variations in temperature and vibration.































SELECTION GUIDE

- Relay selection
- Socket selection
- Ordering scheme
- Options

Relay selection guide - AMRA Line

APPLICATION						
Rolling stock	Railway fixed equipment	Power generation	Power distribution	Petroleum industry	Shipbuilding	Heavy industry
						
✓	✓	✓	✓	✓	✓	✓







Relay model	Product line	Instantaneous monostable	Bistable (latching)	Fast-acting (*)	Time-delayed	V / I monitoring	Coil continuity test	High breaking capacity (**)	PCB (optional)	Contacts	In	Notes	Railway Rolling Stock (***)	Chapter
POK - POKS	A	■							■	2 SPDT	5-10 A	Compact		1.1
BIPOK - BIPOKS	A	■							■	4 SPDT	5-10 A	Compact		1.1
TRIPOK - TRIPOKS	A	■								6 SPDT	5-10 A	Compact		1.1
QUADRIPOK	A	■								8 SPDT	10 A	Compact		1.1
ESAPOK	A	■								12 SPDT	10A	Compact		1.1
OK	A	■						■		4-8-12 SPDT	10 A	Available in Italian Navy version		1.2
RGG	M	■						■		4 SPDT	12 A	Forcibly guided contacts, type A, EN50205		2.3
RV	A	■		■						6 (NO or NC)	5 A	Operating times < 6 ms		1.3
OKBA	A		■					■		4-8 SPDT	10 A			1.4
TM - TMS	A				■					4 SPDT	5-10 A	Delay on pick-up or drop-out, with dipo-switches		1.5
TOK	A				■			■		4 SPDT	10 A	Time delay on pick-up or drop-out		1.6
OKTF	A				■			■		4 SPDT	10 A	Delay on drop-out, fixed duration, no Vaux		1.6
OKR	A				■					4 SPDT	5 A	Time delay on pick-up or drop-out		1.7
OKT	A				■					4 SPDT	5 A	Time delay on pick-up or drop-out		1.7
UTM	A				■			■		-	-	Static time delay unit		1.8
MOK-V2	A	■				■				2 SPDT	8A	Measuring relay, voltage		1.9
OKPH	A	■				■				1 NO	4 A	Phase concordance		1.10
MOK-PH2	A	■				■				2 SPDT	3 A	Phase concordance		1.10
TOK-L	A				■			■		4 SPDT	10 A	Flasher		1.11
OKRE-L	A				■					4 SPDT	5 A	Flasher		1.11
TOK-FP	A				■			■		4 SPDT	10 A	One-shot		1.11
OKRE-FP	A				■					4 SPDT	5 A	One-shot		1.11

* Unless stated otherwise, operating times indicated in the catalogue are understood as being inclusive of bounces

** Relays with contact specifications guaranteeing efficient break of strongly inductive DC loads, even with 220Vdc voltages

*** These relays comply with regulations applicable to rolling stock; also suitable for use in other applications

Relay selection guide - MTI Line

APPLICATION						
Rolling stock	Railway fixed equipment	Power generation	Power distribution	Petroleum industry	Shipbuilding	Heavy industry
						
X*	✓	✓	✓	✓	✓	✓

* Except RGG

Relay model	Product line	Instantaneous monostable	Bistable (latching)	Fast-acting (*)	Time-delayed	V / I monitoring	Coil continuity test	High breaking capacity (**)	PCB (optional)	Contacts	In	Notes	Railway, Rolling Stock (***)	Chapter
RCM	M	■						■		2 SPDT	10 A	Compact		2.1
RDM	M	■						■		4 SPDT	10 A	Compact		2.1
RGM	M	■						■		4 SPDT	12 A			2.2
RGG	M	■						■		4 SPDT	12 A	Forcibly guided contacts, type A, EN50205		2.3
RMM	M	■						■		8-12-20 SPDT	10 A	Multi contact		2.4
RGR	M	■		■						2 SPDT	2 A	Reed type contacts		2.8
RGMV	M	■		■						4 (SPDT or NC)	10 A	Operating times < 8 ms		2.8
RMMV	M	■		■						8 (NO or NC)	10 A	Operating times < 6 ms		2.8
RMMZ11 - 13	M	■		■				■		8 SPDT	10 A	Operating times < 13 ms		2.8
RGB	M		■					■		3-4 SPDT	12 A			2.5
RMBZ1y	M		■					■		8-12-20 SPDT	10 A	Multi contact, coils galvanically separated		2.6
RMB	M		■					■		7-11-19 SPDT	10 A	Multi contact, common negative		2.6
RGBZ11-12	M		■	■				■		3-4 SPDT	12 A	Operating times < 12 ms		2.9
RMBZ30	M		■	■				■		7 SPDT	10 A	Operating times < 18 ms		2.9
RMN	M	■					■	■		4-8-16 SPDT	10 A	Relay with built-in continuity test		2.7
RMD	M		■				■	■		4-8-16 SPDT	10 A	Relay with built-in continuity test		2.7
RDTE	M				■					4 SPDT	10 A	Time delay on pick-up or drop-out		2.10
RDLE-RGLE	M				■					2 SPDT	10 A	Flasher		2.11
RDT15 / 16	M				■					4 SPDT	10 A	Delay on drop-out, adjustable duration, no Vaux		2.12
RGTO	M				■					1 SPDT	5 A	Delay on drop-out, adjustable duration, no Vaux		2.12
TD200x	M	■				■				4 SPDT	10 A	Lamp continuity test		2.13

* Unless stated otherwise, operating times indicated in the catalogue are understood as being inclusive of bounces

** Relays with contact specifications guaranteeing efficient break of strongly inductive DC loads, even with 220Vdc voltages

*** These relays comply with regulations applicable to rolling stock; also suitable for use in other applications

Socket selection guide - AMRA Line



	FRONT connection			REAR connection		
Terminal type	SCREW		DOUBLE CONNECTION SPRING CLAMP	SCREW ⁽¹⁾	DOUBLE FASTON	PCB
Mounting	DIN RAIL PLATE	PLATE	DIN RAIL PLATE	FLUSH		SOLDER
Relay model	Socket model					
POK - POKS	50IP20-I DIN	50L ⁽¹⁾	PAIR080 - PRIR080	53IL	ADF1	65
BIPOK - BIPOKS	48BIP20-I DIN	48BL ⁽¹⁾	PAIR160 - PRIR160	43IL	ADF2	65
TRIPOK - TRIPOKS	78BIP20-I DIN	78BL ⁽¹⁾	PAIR240 - PRIR240	73IL	ADF3	-
QUADRIPOK	96IP20	96BL ⁽¹⁾	PAIR320 - PRIR320	43IL ⁽²⁾	ADF4	65 ⁽²⁾
ESAPOK	156IP20	78BL ⁽²⁾	PAIR480 - PRIR480	73IL ⁽²⁾	ADF6	-
OK	48BIP20-I DIN	48BL ⁽¹⁾	PAIR160 - PRIR160	43IL	ADF2	65
OK 8 contacts	48BIP20-I DIN ⁽²⁾	48BL ⁽¹⁾⁽²⁾	PAIR160 ⁽²⁾ - PRIR160 ⁽²⁾	43IL ⁽²⁾	ADF2 ⁽²⁾	-
OK 12 contacts	48BIP20-I DIN ⁽³⁾	48BL ⁽¹⁾⁽³⁾	PAIR160 ⁽³⁾ - PRIR160 ⁽³⁾	43IL ⁽³⁾	ADF2 ⁽³⁾	-
RGG	48BIP20-I DIN	-	PAIR160 - PRIR160	43IL	ADF2	65
RV	78BIP20-I DIN	-	PAIR240 - PRIR240	73IL	ADF3	-
OKBA	48BIP20-I DIN	48BL ⁽¹⁾	PAIR160 - PRIR160	43IL	ADF2	65
TM - TMS	48BIP20-I DIN	48BL ⁽¹⁾	PAIR160 - PRIR160	43IL	ADF2	65
OKR	48BIP20-I DIN	48BL ⁽¹⁾	PAIR160 - PRIR160	43IL	ADF2	65
OKT	48BIP20-I DIN	48BL ⁽¹⁾	PAIR160 - PRIR160	43IL	ADF2	65
TOK	48BIP20-I DIN	48BL ⁽¹⁾	PAIR160 - PRIR160	43IL	ADF2	65
OKTF	48BIP20-I DIN	48BL ⁽¹⁾	PAIR160 - PRIR160	43IL	ADF2	65
UTM	48BIP20-I DIN	48BL ⁽¹⁾	PAIR160 - PRIR160	43IL	ADF2	65
TOK-L	48BIP20-I DIN	48BL ⁽¹⁾	PAIR160 - PRIR160	43IL	ADF2	65
OKRE-L / CLE	48BIP20-I DIN	48BL ⁽¹⁾	PAIR160 - PRIR160	43IL	ADF2	65
TOK-FP	48BIP20-I DIN	48BL ⁽¹⁾	PAIR160 - PRIR160	43IL	ADF2	65
OKRE-FP	48BIP20-I DIN	48BL ⁽¹⁾	PAIR160 - PRIR160	43IL	ADF2	65
MOK-V2	48BIP20-I DIN	48BL ⁽¹⁾	PAIR160 - PRIR160	43IL	ADF2	65
OKPH	48BIP20-I DIN	48BL ⁽¹⁾	PAIR160 - PRIR160	43IL	ADF2	65
MOK-PH2	48BIP20-I DIN	48BL ⁽¹⁾	PAIR160 - PRIR160	43IL	ADF2	65

(1) Removable screw; also suitable for eyelet terminal

(2) Use 2 sockets for each relay. The sockets must be spaced apart at the distances indicated in the relay data sheets

(3) Use 3 sockets for each relay. The sockets must be spaced apart at the distances indicated in the relay data sheets

For more details, consult the socket data sheets

Socket selection guide - MTI Line



	FRONT connection		REAR connection		
Terminal type	SCREW	DOUBLE CONNECTION SPRING CLAMP	SCREW	DOUBLE FASTON	PCB
Mounting	DIN RAIL PLATE	DIN RAIL PLATE	FLUSH		SOLDER
Relay model	Socket model				
RCM	PAVC081	PAIR085	PRVC081	PRDC081	PRCC081
RDM	PAVD161	PAIR165	PRVD161	-	PRCD161
RGM	PAVG161	-	PRVG161	PRDG161	-
RGG	48BIP20-I DIN	PAIR160 - PRIR160	43IL	ADF2	65
RGR	PAVG161	-	PRVG161	PRDG161	-
RGMV	PAVG161	-	PRVG161	PRDG161	-
RMMx2, RMMx6	PAVM321	-	PRVM321	PRDM321	-
RMMx3, RMMx7	PAVM481	-	PRVM481	PRDM481	-
RMMx4, RMMx8	PAVM801	-	PRVM801	PRDM801	-
RMMV12, RMMV13	PAVM321	-	PRVM321	PRDM321	-
RMMZ11, RMMZ13	PAVM321	-	PRVM321	PRDM321	-
RMNx6, RMDx1	PAVM321	-	PRVM321	PRDM321	-
RMNx7, RMDx2	PAVM481	-	PRVM481	PRDM481	-
RMNx9, RMDx4	PAVM801	-	PRVM801	PRDM801	-
RGB	PAVG161	-	PRVG161	PRDG161	-
RMBx3, RMBZ12	PAVM321	-	PRVM321	PRDM321	-
RMBx5, RMBZ13	PAVM481	-	PRVM481	PRDM481	-
RMBx7, RMBZ14	PAVM801	-	PRVM801	PRDM801	-
RGBZ 10-11	PAVG161	-	PRVG161	PRDG161	-
RMBZ30	PAVM321	-	PRVM321	PRDM321	-
RDTE	PAVD161	PAIR165	PRVD161	-	PRCD161
RDLE	PAVD161	PAIR165	PRVD161	-	PRCD161
RGLE	PAVG161	-	PRVG161	PRDG161	-
RDT15 / 16	PAVD161	PAIR165	PRVD161	-	PRCD161
RGTO	PAVG161	-	PRVG161	PRDG161	-
TD200x	PAVD161	PAIR165	PRVD161	-	PRCD161

For more details, consult the socket data sheets

Ordering scheme

The product code is obtainable from the "Ordering scheme" table indicated in the data sheets for each product.

Ordering scheme		1	2	3	4	5	6	7
Model	Number of SPDT contacts	Product code	Application ⁽¹⁾	Configuration A	Configuration B	Type of input supply	Nominal voltage (V) ⁽²⁾	Keying position ⁽³⁾ / Option
POK	2 - 5A	POK	E: Energy	1: Standard	0: Standard	C: Vdc A: Vac 50 Hz H: Vac 60 Hz	012 - 024 - 036 048 - 072 - 100 110 - 125 - 127 132 - 144 - 220 230	XXX CS = PCB-mount version L = low temperature
POKS	2 - 10A	POKS	F: Railway	2: Diode //	2: P2			
BIPOK	4 - 5A	BPOK	Fixed	3: Varistor	4: P4 GEO			
BIPOKS	4 - 10A	BPOKS	Equipment	4: Led	5: P5 GEO			
TRIPOK	6 - 5A	TPOK		5: Diode // + Led	6: P6 GEO			
TRIPOKS	6 - 10A	TPOKS	R: Railway	6: Varistor + Led	7: P7			
QUADRIPOKS	8 - 10A	QPOK	Rolling	7: Transil	8: P8			
ESAPOKS	12 - 10A	EPOK	Stock	8: Transil + Led				

Example

BPOKS	R	5	8	C	024	
BPOKSR58-C024 - BIPOKS relay, ROLLING STOCK series, nominal voltage 24 Vdc, with diode, LED and P8 finish (gold-plated contacts)						

Ref.	Description
1	PRODUCT CODE: Relay model. This field may correspond exactly to the name of the model (e.g. POKS) or may be an abbreviation of the name (e.g. QPOK = QUADRIPOK).
2	<p>APPLICATION: Sector in which the relay is used. Depending on the sector and application, relays may need to have different finish specifications and to meet special constructional constraints.</p> <p>E: ENERGY Series Relays in standard version. These relays are suitable for use in control, protection, monitoring, automation and similar systems in typically demanding sectors such as the production, transmission and distribution of electrical energy, also petrochemical, shipbuilding and heavy industries in general.</p> <p>F: RAILWAY, Fixed Equipment Relays suitable for use in the railways sector, on fixed equipment, generally power and electric traction systems (trackside tunnel safety switchgear panels, main switchgear panels, power supply panels, AC/DC conversion systems, remote control systems, etc.). Relays of particularly rugged construction, also available with input voltages specific to the rail sector (e.g. 132Vdc, 144 Vdc). If applicable, relays can be manufactured to meet RFI (Italian State Railways Group) specification no. RFI DPRIM STF IFS TE 143 A. The numbering of these relays is different to standard. For list of RFI approved and conforming products, consult dedicated catalogue "RAILWAY SERIES - RFI APPROVED".</p> <p>R: RAILWAY, Rolling Stock Relays suitable for use on rolling stock. In the case of rail, tram, trolley and metro applications, consideration must be given to pertinent regulations governing the sector in question, which specify operating constraints more stringent than those of standard product regulations. "R" relays are suitable for these applications as they comply with such constraints (by way purely of example: SHOCK AND VIBRATION RESISTANCE, REACTION TO FIRE, OPERATING RANGE OF COIL, OPERATING TEMPERATURE, etc.).</p>
3	CONFIGURATION A: Available versions and options.
4	CONFIGURATION B: Available versions and options.
5	TYPE OF INPUT SUPPLY: DC voltage, AC voltage 50 Hz, AC voltage 60 Hz, DC + AC voltage.
6	NOMINAL VOLTAGE: Voltage rating of relay.
7	<p>KEYING POSITION/OPTION: Field used to indicate the possible inclusion of a keying position and/or other options.</p> <ul style="list-style-type: none"> Keying position PCB-mount model (code CS) "R" application (Railway, rolling stock): depending on the model of the relay, coils may be available with operating ranges different to those indicated in EN60077 standard (0.75... 1.25 Un). Consult the data sheets of the single products for more details. <i>Example of code for ordering a special operating range = Z01, Z02, Z03, etc.</i> Options (low temperature, manual operating lever, etc.)

Depending on the product line, there is a wide range of options available.

Options - AMRA Line

Option	Description
P2	Tropicalization of coil with epoxy resin for exposure to 95% RH (@ T 50 °C). This treatment also protects the coil against corrosion that could occur through the combination of humidity and certain chemical agents, such as those found in acid atmospheres (typical of geothermal power stations) or saline atmospheres.
P4GEO	Gold plating of contacts with gold-nickel alloy, thickness $\geq 6\mu$, on nickel. This treatment ensures long-term capacity of the contact to conduct lower currents in harsh ambient conditions such as acid atmospheres (typical of geothermal power stations) or saline atmospheres.
P5GEO	P4GEO gold-plating of contacts + P2 coil tropicalization.
P6GEO	P4GEO type gold-plating, but applied to contacts, contact terminals and output terminals + P2 coil tropicalization.
P7	AgCdO (silver cadmium oxide) contacts.
P8	Gold plating of contacts with gold-cobalt alloy, thickness $\geq 5\mu$, knurled fixed contact. This finish allows further improvement of the performance provided by gold-plated contact, compared to P4GEO treatment.
LED	LED indicator showing presence of power supply, wired in parallel with the coil.
FLYBACK DIODE	Polarized component connected in parallel with the coil (type 1N4007 or BYW56 for rolling stock version) designed to suppress overvoltages generated by the coil when de-energized.
VARISTOR	Non-polarized component connected in parallel with the coil, designed to suppress overvoltages higher than the clamping voltage, generated by the coil when de-energized.
TRANSIL	Non-polarized component connected in parallel with the coil. Behaviour is similar to that of a varistor, with faster operating times.
LOW TEMPERATURE	Minimum operating temperature -50 °C, only for rolling stock version.
C.S.	PCB-mount version (certain models only).

Options - MTI Line

Option	Description
TROPICALIZATION	Surface treatment of the coil with insulation coating for use with RH 95%.
GOLD PLATING	Surface treatment of contacts, blades and output terminals with gold-cobalt alloy, thickness $\geq 2\mu$. This treatment ensures long-term capacity of the contact to conduct lower currents.
LED	LED indicator showing presence of power supply, wired in parallel with the coil.
FLYBACK DIODE	Polarized component connected in parallel with the coil (type 1N4007) (as alternative to mechanical optical indicator) designed to suppress overvoltages generated by the coil when de-energized.
VARISTOR	Non-polarized component connected in parallel with the coil, designed to suppress overvoltages higher than the clamping voltage, generated by the coil when de-energized.
C.S.	PCB-mount version (certain models only).
LEVER FOR MANUAL OPERATION	Allows manual operation of the relay, with the cover closed, using a screwdriver. If the lever is fitted, there will be no luminous optical indicator.





AMRA LINE

Instantaneous monostable relay 2-4-6-8-12 contacts

1.01

POK SERIES

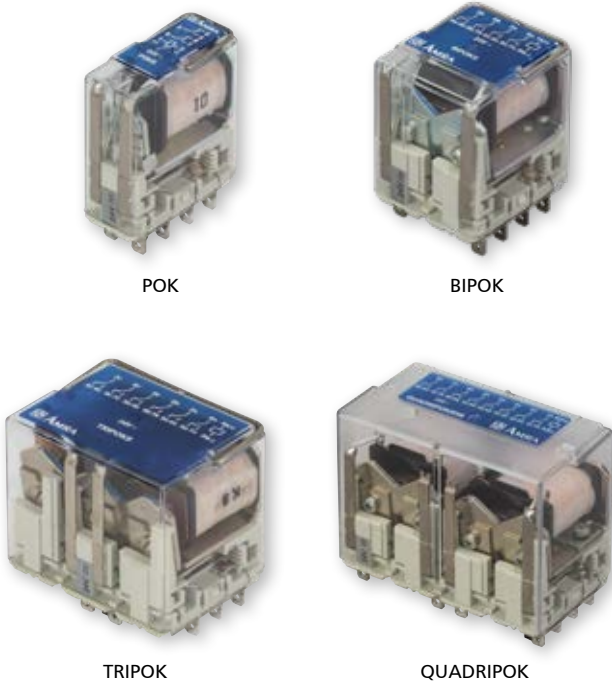

OVERVIEW

- Compact plug-in monostable instantaneous relays
- Solid and rugged construction for heavy or intensive duty
- Considerable long-life
- Independent and self-cleaning contacts
- Separate arc breaking chambers
- Magnetic arc blow-out standard
- Excellent shock and vibration resistance
- Option for use in geothermal sites available
- Also available in current-monitoring version
- Also available in PCB-mount version
- Wide variety of configurations and customizations
- Wide range of sockets
- Retaining clip for secure locking of relay on socket
- Transparent cover, pull-out handle
- Positive mechanical keying for relay and socket

APPLICATIONS



Shipbuilding



Petroleum industry



Heavy industry



Power generation



Power distribution



Railway equipment



Rolling stock

DESCRIPTION

The POK series is made up of 5 basic models, created from a single module with 2 contacts that can be used in multiple combinations to provide solutions with 2 - 4 - 6 - 8 and 12 change-over contacts.

The construction of the relays and careful choice of the materials are such that they ensure long life and considerable ruggedness even in harsh operating environments and in the presence of strong temperature fluctuations.

A specific treatment (P5GEO or P6GEO) combining coil tropicalization with gold-plated contacts allows the use of these items in geothermal electric power stations, as relays for signalling functions, for controlling intermediate devices and for all non-power circuits. Excellent electrical and mechanical performance levels allow the product to be used in the most demanding of sectors such as, for example, control and signalling functions in electricity generating stations, electrical transformer stations, rail transport or in industries with continuous production processes (chemical industry, petroleum industry, rolling mills, cement factories, etc.). Above all, the excellent ability to withstand shock and vibration allow their use on rolling stock.

Safe and reliable operation is guaranteed by

- Contact terminals without connecting braids and soldered joints. The terminals connecting with the socket are provided by a direct extension of the contacts.
- Mechanism without return springs.
- Adoption of all-metallic operating mechanism, unaffected by the thermal ageing that typically degrades organic materials, such as plastics.
- Excellent shock and vibration resistance.
- Notable resistance to high operating temperatures and high thermal shocks.

The self-cleaning contacts are independent, being anchored neither one to another nor to a common operating mechanism. Positioned in separate chambers, they enable better breaking of the arc. In addition, they are equipped with magnetic arc blow-out, guaranteeing a particularly efficient break of direct current loads. The common contact is mounted to a separate return device, consisting in a flexible blade designed to ensure uniformity of the pressures on break contacts. Given their dimensions and specifications, POK relays provide the logical complement to power relays of the OK series.

Models	Number of contacts	Nominal current	Rolling stock application
POK	2	5 A	•
POKS	2	10 A	•
BIPOK	4	5 A	•
BIPOKS	4	10 A	•
TRIPOK	6	5 A	•
TRIPOKS	6	10 A	•
QUADRIPOKS	8	10 A	•
ESAPOKS	12	10 A	

FOR CONFIGURATION OF PRODUCT CODE, SEE "ORDERING SCHEME" TABLE

Coil data	POK - POKS	BIPOK - BIPOKS	TRIPOK - TRIPOKS	QUADRIPOKS	ESAPOKS
Nominal voltages Un ⁽¹⁾	DC: 12-24-36-48-72-96-110-125-132-144-220		AC: 12-24-48-110-127-220-230		
Max. consumption at Un (DC/AC)	2.5W / 3.5 VA	3W / 4 VA	3.5W / 5.5 VA	6W / 8 VA	7W / 11 VA
Operating range ⁽¹⁾	DC: 80...115% Un		AC: 85...110% Un		
Rolling stock version ^{(2) (3)}	DC: 70...125% Un				
Type of duty	Continuous				
Drop-out voltage ⁽⁴⁾	DC: > 5% Un		AC: > 15% Un		

1. Other values on request. For ESAPOKS, values > 24V.

2. See "Ordering scheme" table for order code.

3. For operating ranges different to that specified by EN60077, refer to table "Railways, rolling stock - Special operating ranges".

4. Limit value for supply voltage, expressed as % of the nominal value, beneath which the relay is certainly de-energized.

Contact data	POK - POKS	BIPOK - BIPOKS	TRIPOK - TRIPOKS	QUADRIPOKS	ESAPOKS
Number and type	2 SPDT, Form C	4 SPDT, Form C	6 SPDT, Form C	8 SPDT, Form C	12 SPDT, Form C
	POK - BIPOK - TRIPOK		POKS - BIPOKS - TRIPOKS - QUADRIPOKS - ESAPOKS		
Current	Nominal ⁽¹⁾		10 A		
	Maximum peak (1 min) ⁽²⁾		20 A		
	Maximum pulse (10 ms) ⁽²⁾		150 A		
Example of electrical life expectancy ⁽³⁾	1800 operations/h		1 A - 110 Vdc - L/R 0 ms : 10 ⁵ operations		
	0.2 A - 110 Vdc - L/R 40 ms : 10 ⁵ operations		0.5 A - 110 Vdc - L/R 40 ms : 10 ⁵ operations		
Minimum load	Standard contacts		500 mW (20V, 20 mA)		
	Gold-plated contact P4GEO ⁽⁴⁾		100 mW (10V, 5 mA)		
	Gold-plated contact P8 ⁽⁴⁾		50 mW (5V, 5 mA)		
Maximum breaking voltage	250 Vdc / 350 Vac				
Contact material	AgCu		Ag / AgCu		
Operating time at Un (ms) ^{(5) (6)}	DC - AC				
Pick-up (NO contact closing)	≤ 20 - ≤ 20	≤ 25 - ≤ 25	≤ 25 - ≤ 25	≤ 25 - ≤ 25	≤ 25 - ≤ 25
Drop-out (NC contact closing)	≤ 15 - ≤ 20	≤ 20 - ≤ 40	≤ 20 - ≤ 45	≤ 20 - ≤ 40	≤ 20 - ≤ 45

1. On all contacts simultaneously, reduction of 30%.

2. The max. peak and pulse currents are those currents that can be handled, for a specified time, by the contact. They do not refer to steady or interrupted currents.

3. For other values, see electrical life expectancy curves.

4. Specifications of contacts on new relay

a. Plating material: **P4GEO**: gold-nickel alloy (>6μ) **P8**: gold-cobalt alloy (>5μ), knurled contact

b. When the gold-plated contact is subject to heavy loads, it will be degraded on the surface. In this case, the characteristics of the standard contact should be taken into consideration. This does not impair relay operation.

5. Unless specified otherwise, the operating time signifies until stabilization of the contact (including bounces).

6. Addition of a flyback diode connected in parallel with the coil (DC version only) causes an increase in operating time when the relay drops out.

Insulation	
Insulation resistance (at 500Vdc)	
between electrically independent circuits and between these circuits and ground	> 1,000 MΩ
between open contact parts	> 1,000 MΩ
Withstand voltage at industrial frequency	
between electrically independent circuits and between these circuits and ground	2 kV (1 min) - 2.2 kV (1 s)
between open contact parts	1 kV (1 min) - 1.1 kV (1 s)
between adjacent contacts	2.5 kV (1 min) - 3 kV (1 s)
Impulse withstand voltage (1.2/50μs - 0.5J)	
between electrically independent circuits and between these circuits and ground	5 kV
between open contact parts	3 kV

Mechanical specifications

Mechanical life expectancy		DC: 20 x 10 ⁶ AC: 10 x 10 ⁶ operations			
Maximum switching rate		3,600 operations / hour			
Degree of protection (with relay mounted)		IP40			
	POK-POKS	BIPOK-BIPOKS	TRIPOK-TRIPOKS	QUADRIPOKS	ESAPOKS
Dimensions (mm) ⁽¹⁾	20 x 50 x 45	40 x 50 x 45	60 x 50 x 45	80 x 61 x 45	120 x 50 x 45
Weight (g)	~ 90	~ 170	~ 250	~ 340	~ 520

1. Output terminals excluded.

Environmental specifications

Operating temperature	Standard	-25° to +55°C
	Version for railways, rolling stock	-25° to +70°C
Storage and shipping temperature		-50° to +85°C
Relative humidity		Standard: 75% RH - Tropicalized: 95% RH
Resistance to vibrations		5g - 10 to 55 Hz - 1 min
Resistance to shock		20g - 11 ms
Fire behaviour		V0

Standards and reference values

EN 61810-1, EN 61810-2, EN 61810-7 EN 60695-2-10 EN 50082-2 EN 60529	Electromechanical elementary relays Fire behaviour Electromagnetic compatibility Degree of protection provided by enclosures
---	---

Unless otherwise specified, the products are designed and manufactured according to the requirements of the above-mentioned European and International standards. In accordance with EN 61810-1, all items of technical data are referred to ambient temperature 23 °C, atmospheric pressure 96kPa and 50% humidity. Tolerance for coil resistance, nominal electrical input and nominal power is ±7%.

Railways, rolling stock - Standards

EN 60077 EN 50155 EN 61373 EN 45545-2 ASTM E162, E662	Electric equipment for rolling stock - General service conditions and general rules Electronic equipment used on rolling stock Shock and vibration tests, Cat 1, Class B Fire behaviour, Cat E10, Requirement R26, V0 Fire behaviour
---	--

Railways, rolling stock - Special operating ranges for POK(s) - BIPOK(s) relays ⁽¹⁾

Nominal voltage	Minimum pick-up voltage	Maximum operating voltage	Order symbol ⁽¹⁾
24 Vdc	18	33	Z01
24 Vdc	16	32	Z02
24 Vdc	16,8	32	Z03
24 Vdc	19	30	Z04
36 Vdc	28	46	Z01
72 Vdc	55	104	Z01
72 Vdc	55	96	Z02
110 Vdc	77	144	Z01

(1) To order the relay with the special operating range, indicate the "Z0x" symbol in the "Keying position" field of the ordering scheme. The special range may be subject to operating specifications different from standard specifications. Please contact us for further information.



Configuration Options

P2	Tropicalization of the coil with epoxy resin for use with 95% RH (@ T 50 °C). This treatment also protects the coil against corrosion which could occur by combination of the humidity with certain chemical agents, such as those found in acid atmospheres (typical of geothermal power stations) or saline atmospheres.
P4GEO	Gold plating of contacts with gold-nickel alloy, thickness $\geq 6\mu$. This treatment ensures long-term capacity of the contact to conduct lower currents in harsh ambient conditions such as acid atmospheres (typical of geothermal power stations) or saline atmospheres.
P5GEO	P4GEO gold-plating of contacts + P2 coil tropicalization.
P6GEO	P4GEO type gold-plating, but applied to contacts, contact terminals and output terminals + P2 coil tropicalization.
P7	AgCdO (silver cadmium oxide) contacts.
P8	Gold plating of contacts with gold-cobalt alloy, thickness $\geq 5\mu$, knurled fixed contact. This finish allows further improvement of the performance provided by gold-plated contact, compared to P4GEO treatment.
LED	LED indicator showing presence of power supply, wired in parallel with the coil.
FLYBACK DIODE	Polarized component connected in parallel with the coil (type 1N4007 or BYW56 for rolling stock version) designed to suppress overvoltages generated by the coil when de-energized.
VARISTOR	Non-polarized component connected in parallel with the coil, designed to suppress overvoltages higher than the clamping voltage, generated by the coil when de-energized.
TRANSIL	Non-polarized component connected in parallel with the coil. Behaviour is similar to that of a varistor, with faster operating times.
LOW TEMPERATURE	Minimum operating temperature -50°C , only for rolling stock version (option "L").
C.S.	PCB-mount version (for POK-POKS-BIPOK-BIPOKS only).



Ordering scheme

Model	Number of SPDT contacts	Product code	Application ⁽¹⁾	Configuration A	Configuration B	Type of power supply	Nominal voltage (V) ⁽²⁾	Keying position ⁽³⁾ / option
POK	2 - 5A	POK	E: Energy Railway Fixed Equipment	1: Standard	0: Standard	C: Vdc A: Vac 50 Hz H: Vac 60 Hz	012 - 024 - 036 048 - 072 - 096 100 - 110 - 125 127 - 132 - 144 220 - 230	XXX CS = PCB-mount version L = low temperature
POKS	2 - 10A	POKS		2: Diode //	2: P2			
BIPOK	4 - 5A	BPOK		3: Varistor	4: P4 GEO			
BIPOKS	4 - 10A	BPOKS		4: Led	5: P5 GEO			
TRIPOK	6 - 5A	TPOK	R: Railway Rolling Stock	5: Diode // + Led	6: P6 GEO			
TRIPOKS	6 - 10A	TPOKS		6: Varistor + Led	7: P7			
QUADRIPOKS	8 - 10A	QPOK		7: Transil	8: P8			
ESAPOKS	12 - 10A	EPOK		8: Transil + Led				

Example	TPOKS	E	3	0	A	230		
	TPOKSE30-A230 - TRIPOKS relay, ENERGY series, nominal voltage 230 Vac, equipped with varistor							
	BPOKS	R	5	8	C	024		
	BPOKSR58-C024 - BIPOKS relay, ROLLING STOCK series, nominal voltage 24 Vdc, equipped with diode, LED, with P8 finish (gold-plated contacts)							
	POK	R	1	0	C	110	L	
POKR10 - C110 L - POK relay, rolling stock series, nominal voltage 110 Vdc with option "L" (low temp.)								

(1) E = ENERGY: all applications, except for railways rolling stock.

Suitable on energy production, transport and distribution plants, railways fixed equipment, petrochemical and heavy industry.

R = RAILWAYS, ROLLING STOCK: Application on board rolling stock (rail-tram-trolley vehicles). Electrical characteristics according to EN60077.

Available also the product series:

RAILWAYS, FIXED EQUIPMENT: Approved and conforming relays and products to RFI (FS Group) specification no. RFI DPRIM STF IFS TE 143 A

For the list of RFI approved and conforming products, consult dedicated catalogue "RAILWAY SERIES - RFI APPROVED".

STATIONS: ENEL approved material meeting LV15/LV16 specifications.

For the list of ENEL approved and conforming products, consult the dedicated catalogue "STATIONS SERIES - LV15-LV16-LV20".

(2) Other values on request.

(3) Optional value. PCB-mount version available for POK - POKS - BIPOK - BIPOKS only. Multiple selection possible (e.g. CS - L). The positive mechanical keying is applied according to the manufacturer's model (not available for PCB-mount versions).

Wiring diagram

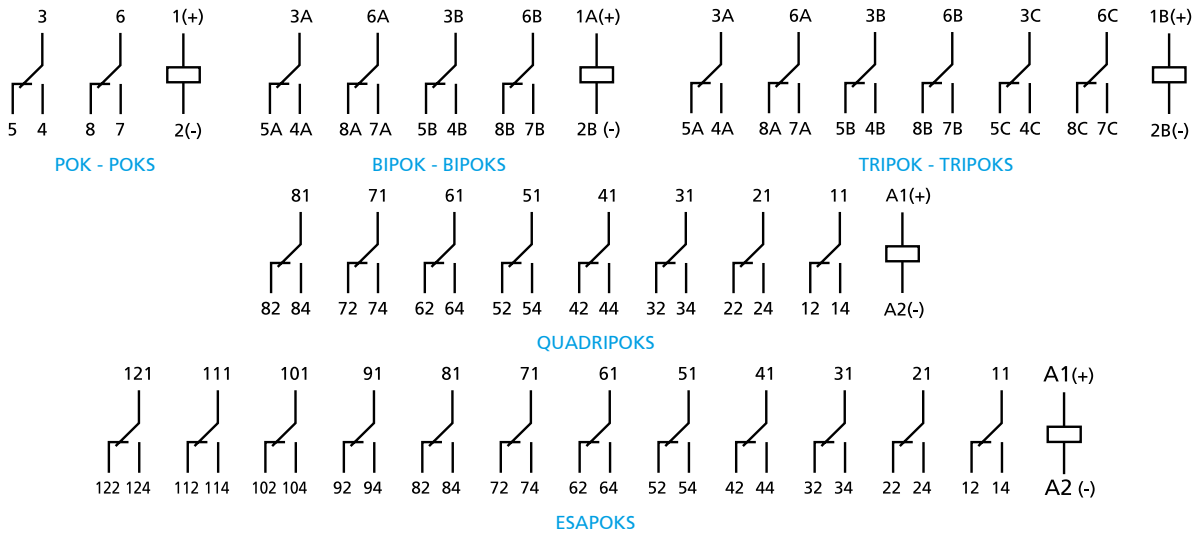

Dimensions

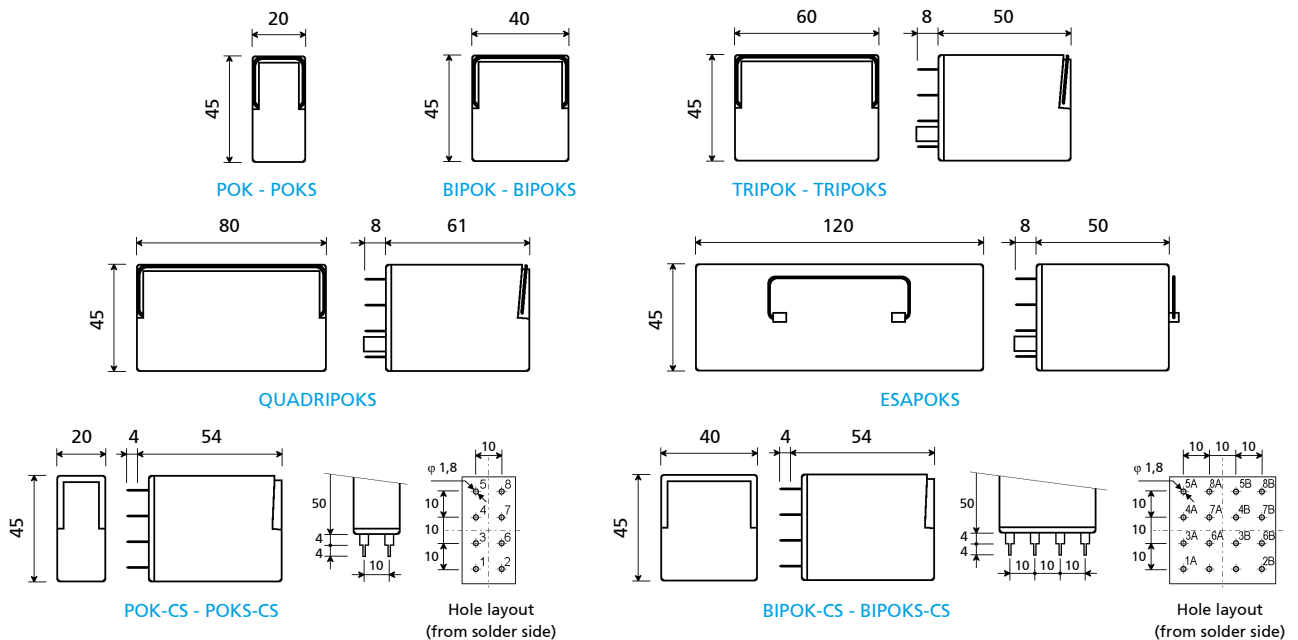

Electrical life expectancy

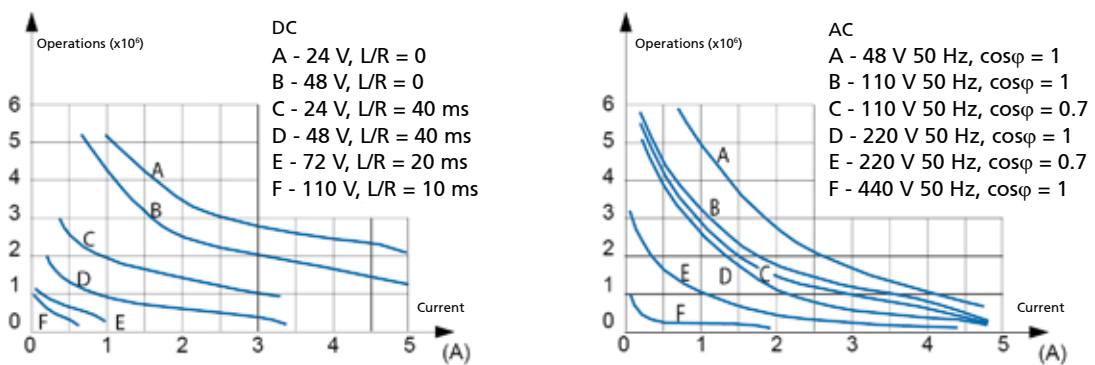

Some examples of electrical life expectancy

- 48Vdc - 5 A - L/R = 10 ms : 5×10^5 operations
- 80Vdc - 5 A - Resistive : 5×10^5 operations
- 110Vdc - 0.5 A - L/R = 10 ms : 5×10^5 operations

- 220Vdc - 0.2 A - L/R = 10 ms : 10^5 operations
- 110Vac - 5 A - $\cos\phi = 0.7$: 5×10^5 operations
- 220Vac - 3 A - $\cos\phi = 0.7$: 5×10^5 operations
- 440Vac - 0.2 A - Resistive : 5×10^5 operations

Sockets	POK - POKS	BIPOK - BIPOKS	TRIPOK - TRIPOKS	QUADRIPOKS	ESAPOKS
Number of terminals	8	16	24	32	48
For wall or rail mounting					
Spring clamp, wall or DIN H35 rail mounting	PAIR080	PAIR160	PAIR240	PAIR320	PAIR480
Screw, wall or DIN H35 rail mounting	50IP20-I DIN	48BIP20-I DIN	78BIP20-I DIN	96IP20-I DIN	156IP20-I DIN
Screw, wall mounting	50L	48BL	78BL	96BL	156BL
For flush mounting					
Spring clamp	PRIR080	PRIR160	PRIR240	PRIR320	PRIR480
Double faston (4.8 x 0.8 mm)	ADF1	ADF2	ADF3	ADF4	ADF6
Screw	53IL	43IL	73IL	-	-
For mounting on PCB					
	65 ⁽¹⁾	65	-	-	-

(1) Suitable for mounting 2 relays side by side.

Retaining clips – correspondence with sockets	POK - POKS	BIPOK - BIPOKS	TRIPOK - TRIPOKS	QUADRIPOKS	ESAPOKS
Number of clips per relay	1	1 ⁽¹⁾	2	2	2
SOCKET MODEL	CLIP MODEL				
For wall or rail mounting					
PAIR080, PAIR160, PAIR240, PAIR320, PAIR480	RPB48	RPB48	RPB48	RQ48	RPB48
50IP20-I DIN, 48BIP20-I DIN, 78BIP20-I DIN, 96IP20-I DIN, 156IP20-I DIN	RPB48	RPB48	RPB48	RQ48	RPB48
50L, 48BL, 78BL, 96BL, 156BL	RPB48	RPB48	RPB48	RQ48	RPB48
For flush mounting					
PRIR080, PRIR160, PRIR240, PRIR320, PRIR480	RPB48	RPB48	RPB48	RQ48	RPB48
ADF1, ADF2, ADF3, ADF4, ADF6	RPB48	RPB48	RPB48	RQ48	RPB48
ADF, 53IL, 43IL, 73IL ⁽²⁾	RPB43	RPB43	RPB43	-	-
For mounting on PCB					
65	RPB43	RPB43	-	-	-

(1) Assume two clips for use on rolling stock.

(2) Insert the clip before fastening the socket on the panel.

Mounting tips

The preferred mounting position is on the wall, with the relay positioned horizontally in the reading direction on the nameplate.

For correct use of the relays, they should be spaced apart by at least 5 mm in the horizontal direction and 20 mm in the vertical direction. This is to allow correct upward dissipation of the heat generated by the coil. Set these distances according to the socket used. Distances can be reduced depending on the environmental application conditions and on the relay duty cycle.

For safe and secure operation, it is advisable to use retaining clips.

No special maintenance is required.

Condensation can form inside the relay when powered up and the outside ambient temperature is cold; this is quite normal and does not affect the operation of the relay. The plastic materials of the relay do not possess hygroscopic properties.

Instantaneous monostable relay

4-8-12 contacts

1.02

OK SERIES



OKUIC

OVERVIEW

- Plug-in monostable instantaneous relay
- Solid and rugged construction for heavy or intensive duty
- Very high electrical life expectancy and exceptional endurance
- Patent operating mechanism, designed to ensure high contact pressure
- Ample clearance between open contact elements (from 1.2 to 4 mm)
- Independent and self-cleaning contacts with high breaking capacity
- Magnetic arc blow-out for higher breaking capacity
- Excellent shock and vibration resistance
- Wide variety of configurations and customizations
- Option for use in geothermal sites available
- Wide range of sockets
- Retaining clip for secure locking of relay on socket
- Transparent cover, pull-out handle
- Positive mechanical keying for relay and socket

APPLICATIONS



Shipbuilding



Petroleum industry



Heavy industry



Power generation



Power distribution



Railway equipment



Rolling stock

DESCRIPTION

The OK series is made up of 7 basic models, created from a common operating mechanism of patent design, equipped with 4 contacts. Solutions with 8 or 12 contacts are obtainable by using 2 or 3 relays in combination.

The construction of the relays and careful choice of the materials are such that they ensure long life and considerable ruggedness even in harsh operating environments and when subject to strong thermal shocks.

A specific treatment (P5GEO or P6GEO) combining coil tropicalization with gold-plated contacts allows the use of these items in geothermal electric power stations, as final relays for controlling field devices and for all power circuits.

Relays of the OK series utilize a patent switching mechanism designed to minimize friction, resulting in a mechanical life expectancy of at least 100,000,000 operations. This is made possible thanks to:

- the use of a solenoid with a core drawn in toward the main air gap, located at the centre of the coil, the only position in which the available magnetic flux can be exploited to the full
- the core motion being limited to the minimum, thereby optimizing mechanical forces and reducing friction. The motion is amplified by means of a W linkage, which allows an appreciable displacement of the contact (> 4 mm in the case of the version with NO contacts)
- the coil of elongated cylindrical geometry, best able to ensure high efficiency and effective dissipation of the heat produced.

Each contact is mounted to individual and independent blades, which are able to provide optimum shock and vibration resistance. In particular, this generates pressure of around 0.8...1N on the make and break contacts, which is unparalleled by other products. The common contact slides against the fixed poles (NO and NC contacts) both when opening and when closing, which ensures a notably effective self-cleaning action.

With ample clearance between the open contact elements, it becomes possible to guarantee an impulse withstand voltage of 5 kW between the poles of the single contact.

Excellent electrical and mechanical performance levels allow the product to be used in the most demanding of sectors such as, for example, control and signalling functions in electricity generating stations, electrical transformer stations, rail transport or in industries with continuous production processes (chemical industry, petroleum industry, rolling mills, cement factories, etc.). Above all, the excellent ability to withstand shock and vibration allow their use in seismic environments or on rolling stock.



Description of models

Relays of the OK series are made in 7 models (OK, OKS, OKFC, OKSFC, OKSCD, OKSGcCd and OKUIC). The outputs are available on 16 terminals of standard dimensions 5x0.8mm, evenly and symmetrically divided into 4 rows spaced 10mm apart, in both directions. Internal connections are ordered symmetrically. Turning the relay through 180° on its connector has the effect simply of changing the contacts, without affecting operation (except in the case of relays with a polarized power input).

OK – OKS

The OK relay offers features of ruggedness, easy installation, high breaking capacity (with magnetic arc blow-out, model OKS), safe operation and adaptability to any kind of circuit, making it suitable for all heavy duty applications in the field of remote control systems and automation. The distance between contacts is 2.2mm. Superior shock and vibration resistance ensures that contacts are able to hold their operating position even when exposed to a shock force of 30g - 1ms. No opening of break contacts up to 3g. On the OKS model, a powerful magnetic arc blow-out located between the 4 change-over contacts has the effect of generating a permanent magnetic field. When an inductive load circuit is broken, the resulting arc is swiftly extended and finally extinguished through the action of the magnetic field created by the blow-out.

OKFC - OKSFC - OKUIC

The OKFC relay is an energy saving component. The distance between contacts is 1.2mm. Contact pressures and shock and vibration resistance are the same as specified for OK/OKS models. In the case of d.c. loads, the breaking capacity is reduced from that of the OK relay, although the addition of the magnetic arc blow-out (model OKSFC) provides breaking capacity of up to 15 A at 120Vdc (see example of electrical life expectancy).

On the OKSFC model, a powerful magnetic arc blow-out located between the 4 change-over contacts has the effect of generating a permanent magnetic field. When an inductive load circuit is broken, the resulting arc is swiftly extended and extinguished through the action of the magnetic field created by the blow-out. With direct current, breaking capacity is doubled. For d.c. and a.c. currents that can be broken without the blow-out, the effect of having this feature available will be to reduce wear on the contacts, doubling electrical life expectancy. The connection of 2 contacts in series increases electrical life expectancy and doubles breaking capacity when handling direct current. The connection of 2 contacts in parallel likewise increases electrical life expectancy.

In the event that the 4 contacts are all available for breaking purposes, it is possible to use a series/parallel connection arrangement as illustrated below.

In the case of high voltages, from 250V upwards, it is best to avoid breaking opposite polarities on adjacent contacts.

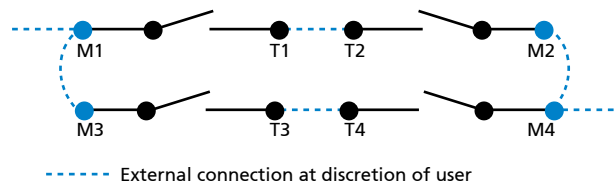

The use of the OKFC or OKSFC relay is advisable whenever the requirement is for detecting loss of voltage, hence where relays are permanently powered up, or when the ambient temperature may reach 70 °C. These relays can be powered up permanently, even at the maximum voltage of the specified operating range; they can also handle wide fluctuations in voltage and consequently are able to respond, for example, to standards for rolling stock, as in the case of the OKUIC model, which has a coil with a wide operating range.

OKSCD

The silver-coated contacts of normal relays can fuse together when closed if exposed to a peak current of 50 A for at least 5 ms. Using cadmium oxide contacts, the surfaces will fuse only at currents higher than 150 A. With magnetic arc blow-out fitted as standard to these relays, there is no possibility of the arc creating a hot spot between the contacts that could cause them to become welded together.

This relay is especially suitable for handling highly inductive direct current loads, and circuits with filament lamps where the closing of contacts can produce current peaks of up to 10 or 15 times the nominal strength (public or industrial lighting systems). It can also be used for starting small electric motors and other appliances that produce high transient currents. The OKSCD relay has an electrical life expectancy equal to that of the OKS relay, but is also suitable for use with circuits generating high transient currents, given the factors indicated above. Controlling a circuit with 600W filament lamps connected to a 110Vac supply, for example, the OKSCD relay is capable of 1,500,000 operations.

OKSGcCd

The OKSGcCd relay has a longer electrical life expectancy than the OKScd model. It has 4 normally open contacts, and a distance between contacts of > 4mm. Magnetic arc blow-out is fitted as a standard feature. The OKSGcCd relay can be used with heavily inductive d.c. loads, where there is no need for change-over contacts.

SPECIAL ITALIAN NAVY SPECIFICATION

OK, OKS, OKFC and OKSFC models can be made in a special Italian Navy version, which features gold-plated terminals and contacts and tropicalization of the relay coil. A special fixing bracket can be supplied, made of 304 grade stainless steel, which replaces the classic retaining clip.

Models	Number of contacts	Continuous duty	Magnetic arc blow-out	AgCdO contacts	Long travel	Rolling stock application
OK	4 ⁽¹⁾					
OKS			•			
OKFC		•				
OKSFC		•	•			
OKSCd			•	•		
OKSGcCd			•	•	•	
OKUIC		•	•			•

1. Versions with 8 and 12 contacts available (excluding OKUIC, OKSCd and OKSGcCd).

FOR CONFIGURATION OF PRODUCT CODE, SEE "ORDERING SCHEME" TABLE

Coil data	OK - OKS	OKFC - OKSFC	OKSCd - OKSGcCd	OKUIC
Nominal voltages Un (1)	DC: 12-24-36-48-72-110-125-132-144-220		AC: 12-24-48-110-115-127-220-230-380	
Max. consumption at Un (DC/AC) (2)	4.5 W / VA	3.5 W / VA	5 W / VA	3.5 W
Operating range (1)	DC: 80...110% Un AC: 85...115% Un	DC: 80...120% Un AC: 85...115% Un	DC: 80...110% Un AC: 80...110% Un	DC: 70...125% Un (3)
Type of duty	Continuous at Un ⁽⁴⁾	Continuous	Continuous at Un ⁽⁴⁾	Continuous
Drop-out voltage ⁽⁵⁾	DC: > 5% Un		AC: > 15% Un	

- Other values on request.
- For versions with 8 and 12 contacts, double and treble the value respectively.
- For operating ranges different to that specified by EN60077, refer to table "OKUIC - Special Ranges".
- Continuous duty is possible at the maximum voltage of the operating range at Tmax: 40 °C.
- Limit value for supply voltage, expressed as % of the nominal value, beneath which the relay is certain to be de-energized.

Contact data	OK - OKS - OKFC - OKSFC - OKUIC	OKSCd	OKSGcCd	
Number and type ⁽¹⁾	4 SPDT, Form C	4 SPDT, Form C	4 N.O.	
Current				
Nominal ⁽²⁾	10 A	10 A	10 A	
Maximum peak (1 min) ⁽³⁾	20 A	20 A	20 A	
Maximum pulse (10 ms) ⁽³⁾	150 A	250 A	250 A	
Example of electrical life expectancy ⁽⁴⁾ 1,800 operations/hour	OK	0.7 A – 120 Vdc – L/R 0 ms : 5.5 x 10 ⁵ operations		
	OKS	1 A – 120 Vdc – L/R 40 ms : 5 x 10 ⁵ operations		
	OKFC	0.5 A – 110 Vdc – L/R 40 ms : 10 ⁵ operations		
	OKSFC - OKUIC	0.7 A – 132 Vdc – L/R 40 ms : 10 ⁵ operations		
	OKSCd	1 A – 120 Vdc – L/R 40 ms : 5 x 10 ⁵ operations		
	OKSGcCd	5 A – 110 Vdc – L/R 20 ms : 2 x 10 ⁵ operations		
Minimum load	Standard contacts	500 mW (20V, 20 mA)		
	Gold-plated contacts ⁽⁵⁾	200 mW (20V, 5 mA)		
Maximum breaking voltage	350 Vdc / 440 Vac			
Contact material	AgCu		AgCdO	
Operating time at Un (ms) ^{(6) (7)}	OK-OKS-OKSCd	OKFC-OKSFC	OKSGcCd	OKUIC
	DC – AC			
	Pick-up (NO contact closing)	≤ 28 - ≤ 40	≤ 38 - ≤ 40	≤ 30 - ≤ 45
Drop-out (NC contact closing)	≤ 20 - ≤ 70	≤ 18 - ≤ 80	-	≤ 18

- Versions with 8 and 12 SPDT contacts available, excluding OKUIC, OKSCd and OKSGcCd.
- On all contacts simultaneously.
- The max. peak and pulse currents are those currents that can be handled, for a specified time, by the contact. They do not refer to steady or interrupted currents.
- For other values, see electrical life expectancy curves.
- Specifications of contacts on new relay
 - Plating material: **P4GEO**: gold-nickel alloy (>6μ).
 - When the gold-plated contact is subject to heavy loads, it will be degraded on the surface. In such case, the characteristics of the standard contact should be taken into consideration. This does not impair relay operation.
- Unless specified otherwise, the operating time signifies until stabilization of the contact (including bounces).
- Addition of a flyback diode connected in parallel with the coil (DC version only) causes an increase in operating time when the relay drops out.



Insulation

Insulation resistance (at 500Vdc)		
between electrically independent circuits and between these circuits and ground		> 1,000 MΩ
between open contact parts		> 1,000 MΩ
Withstand voltage at industrial frequency		
between electrically independent circuits and between these circuits and ground		2 kV (1 min) - 2.2 kV (1 s)
between open contact parts		2 kV (1 min) - 2.2 kV (1 s)
between adjacent contacts		2 kV (1 min) - 2.2 kV (1 s)
Impulse withstand voltage (1.2/50µs - 0.5J)		
between electrically independent circuits and between these circuits and ground		5 kV
between open contact parts		5 kV



Mechanical specifications

Mechanical life expectancy			100 x 10 ⁶ operations			
Maximum switching rate		Mechanical	3,600 operations / hour			
Degree of protection (with relay mounted)			IP20 / IP40 or IP50 as option ⁽³⁾			
Type of power supply, n° SPDT	VDC, 4 SPDT	VAC, 4 SPDT	VDC, 8 SPDT	VAC, 8 SPDT	VDC, 12 SPDT	VAC, 12 SPDT
Dimensions (mm) ^{(1) (2)}	45x97x45	45x109x45	91.5x97x45	91.5x109x45	138x97x45	138x109x45
Weight (g)	~ 280	~ 280	~ 590	~ 590	~ 890	~ 890

1. Output terminals excluded.

2. OKUIC relay: H 109mm for standard version, H 97mm for version with LED, DIODE, VARISTOR.

3. To order the relay with IP40 or IP50 protection, configure the ordering code by the "Keying position" column in "Ordering scheme".



Environmental specifications

Operating temperature	OKUIC	-25° to +55°C
Storage and shipping temperature		-25° to +70°C
Relative humidity		-40° to +85°C
Resistance to vibrations		Standard: 75% RH - Tropicalized: 95% RH
Resistance to shock		5g - 10 to 60 Hz - 1 min
Fire behaviour		30g - 11 ms
		V0



Standards and reference values

EN 61810-1, EN 61810-2, EN 61810-7	Electromechanical elementary relays
EN 60695-2-10	Fire behaviour
EN 50082-2	Electromagnetic compatibility
EN 60529	Degree of protection provided by enclosures

Unless otherwise specified, products are designed and manufactured according to the requirements of the European and International standards indicated above.

In accordance with EN 61810-1, all items of technical data are referred to ambient temperature 23 °C, atmospheric pressure 96kPa and 50% humidity.

Tolerance for coil resistance, nominal electrical input and nominal power is ±7%.



Railways, rolling stock - Standards

EN 60077	Electric equipment for rolling stock - General service conditions and general rules
EN 50155	Electronic equipment used on rolling stock
EN 61373	Shock and vibration tests, Cat 1, Class B
EN 45545-2	Fire behaviour, Cat E10, Requirement R26, V0
ASTM E162, E662	Fire behaviour



Railways, rolling stock - Special operating ranges for OKUIC relay ⁽¹⁾

Nominal voltage	Minimum pick-up voltage	Maximum operating voltage	Order symbol ⁽¹⁾
24 Vdc	18	33	Z01
36 Vdc	28	48	Z01
72 Vdc	55	110	Z01
110 Vdc	77	144	Z01
128 Vdc	85	160	Z01

(1) To order the relay with the special operating range, indicate the "Z0x" symbol in the "Keying position" field of the ordering scheme. The special range may be subject to operating specifications different from standard specifications. Please contact us for further information.



P2	Tropicalization of the coil with epoxy resin for use with 95% RH (@ T 50 °C). This treatment also protects the coil against corrosion which could occur by the combination of humidity with certain chemical agents, such as those found in acid atmospheres (typical of geothermal power stations) or saline atmospheres.
P4GEO	Gold plating of contacts with gold-nickel alloy, thickness $\geq 6\mu$. This treatment ensures long-term capacity of the contact to conduct lower currents in harsh ambient conditions such as acid atmospheres (typical of geothermal power stations) or saline atmospheres.
P5GEO	P4GEO gold-plating of contacts + P2 coil tropicalization.
P6GEO	P4GEO type gold-plating, but applied to contacts, contact terminals and output terminals + P2 coil tropicalization.
LED	LED indicator showing presence of power supply, wired in parallel with the coil.
FLYBACK DIODE	Polarized component connected in parallel with the coil (type 1N4007 or BYW56 for rolling stock version) designed to suppress overvoltages generated by the coil when de-energized.
VARISTOR	Non-polarized component connected in parallel with the coil, designed to suppress overvoltages higher than the clamping voltage, generated by the coil when de-energized.
TRANSIL	Non-polarized component connected in parallel with the coil. Behaviour is similar to that of a varistor, with faster operating times.
IP40	IP40 protection with "6" handle or closure with screws.
IP50	IP50 protection with "6" handle (only for 4 SPDT version).
8 CONTACTS	Version with 8 change-over contacts, obtained using 2 x 4 SPDT relay, coils connected in series.
12 CONTACTS	Version with 12 change-over contacts, obtained using 3 x 4 SPDT relay, coils connected in series.

Ordering scheme



Product code	Number of contacts	Application ⁽¹⁾	Configuration A	Configuration B	Type of power supply	Nominal voltage (V) ⁽²⁾	Keying position code ⁽³⁾
OK OKS OKFC OKSFC OKUIC OKSCd OKSGcCd	4: SPDT ⁽⁴⁾ 8: 8 SPDT 12: 12 SPDT	E: Energy Railway Fixed Equipment R: Railway Rolling Stock M: MMI	1: Standard 2: Diode // 3: Varistor 4: Led 5: Diode // + Led 6: Varistor + Led 7: Transil 8: Transil + Led	0: Standard 2: P2 4: P4 GEO 5: P5 GEO 6: P6 GEO 7: P7 8: P8	C: Vdc A: Vac 50 Hz H: Vac 60 Hz	012 - 024 - 036 048 - 072 - 100 110 - 115 - 125 127 - 132 - 144 220 - 230 - 380	XXX A: IP50 B: IP40

Example	OKS	M	1	6	H	115	
	OKSM16-H115 - OKS relay, ITALIAN NAVY series, nominal voltage 115 Vac 60 Hz, with P6 GEO finish (P4GEO gold-plated contacts + P2 coil tropicalization)						
	OKSFC	E	2	0	C	110	
OKSFCE20-C110 - OKSFC relay, ENERGY series, nominal voltage 110 Vdc, equipped with flyback diode							

(1) **E = ENERGY:** all applications, except for railways rolling stock.

Suitable on energy production, transport and distribution plants, railways fixed equipment, petrochemical and heavy industry.

R = RAILWAYS, ROLLING STOCK: Application on board rolling stock (rail-tram-trolley vehicles). Electrical characteristics according to EN60077.

Available also the product series:

RAILWAYS, FIXED EQUIPMENT: Approved and conforming relays and products to RFI (F5 Group) specification no. RFI DPRIM STF IF5 TE 143 A

For the list of RFI approved and conforming products, consult dedicated catalogue "RAILWAY SERIES – RFI APPROVED".

STATIONS: ENEL approved material meeting LV15/LV16 specifications.

For the list of ENEL approved and conforming products, consult the dedicated catalogue "STATIONS SERIES – LV15-LV16-LV20".

(2) Other values on request. Voltage 380V available as Vac only.

(3) Optional value. The positive mechanical keying is applied according to the manufacturer's model.

(4) For the standard version with 4 contacts, the field must be left empty.

Wiring diagram

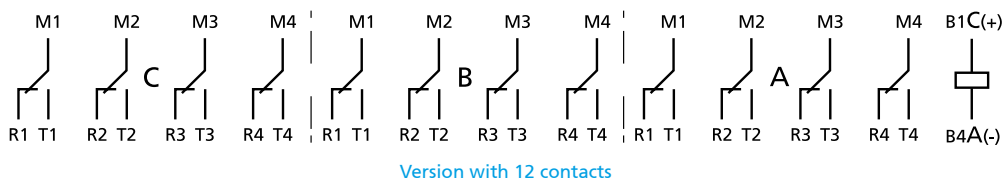
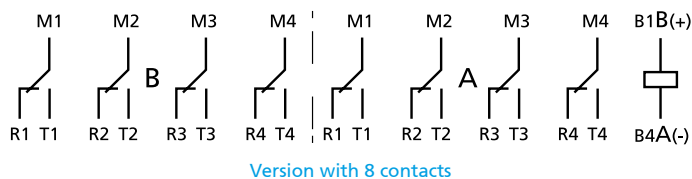
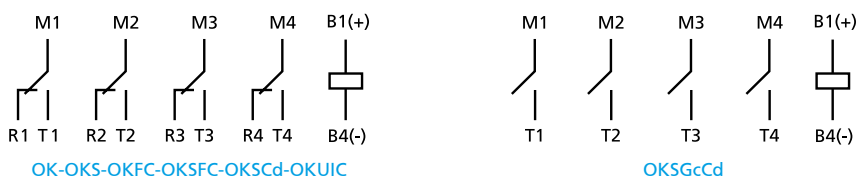

Dimensions

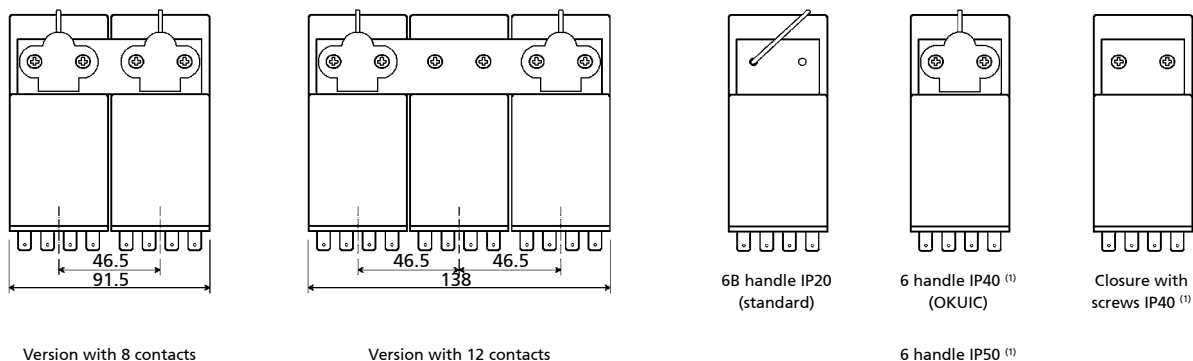
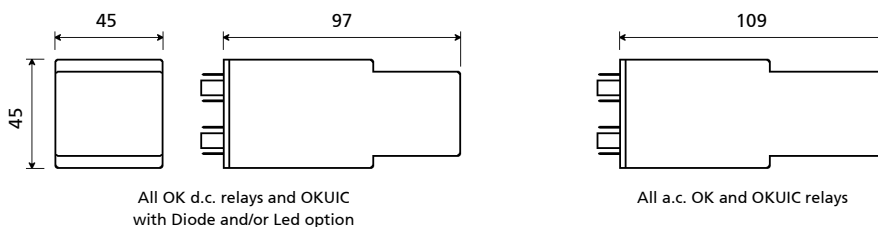

(1) IP40 or IP50 protection could be requested as an option. See "Ordering scheme" for code details.

Examples of electrical life expectancy

	U (Contact)	I (A)	L/R (ms) cosφ	Operations	Notes		U (Contact)	I (A)	L/R (ms) cosφ	Operations	Notes	
OK	540Vac	3	cosφ = 0.5	15,000	②	OKFC	220Vac	10	cosφ = 0.7	500,000		
	380Vac	15	cosφ = 1	10,000	②		110Vdc	0.5	L/R = 5	1,000,000		
		10	cosφ = 1	200,000	◆		80Vdc	1	L/R = 0	2,000,000		
		3x3.3	cosφ = 0.8	200,000	◆	48Vdc	5	L/R = 0	1,000,000			
	220Vac	20	cosφ = 1	20,000	②	OKSFC OKUIC	120Vdc	15	L/R = 0	100	②	
		15	cosφ = 0.5	20,000	②				L/R = 0	2,000,000	③	
		10	cosφ = 1	400,000	◆				L/R = 10	500,000	②	
		3x6	cosφ = 0.8	200,000	●				L/R = 10	100,000		
		5	cosφ = 1	1,500,000					L/R = 10	500,000		
		5	cosφ = 1	3,000,000					80Vdc	25	L/R = 0	100
2.5		cosφ = 0.25	2,000,000		15					L/R = 20	100	②
2	cosφ = 1	15,000,000		10	L/R = 0		400,000					
1.25	cosφ = 1	30,000,000		7.5	L/R = 0		1,500,000					
120Vdc	1.5	L/R = 0	550,000		5		L/R = 10	400,000				
48Vdc	10	L/R = 0	1,000,000									
	1.5	L/R = 5	18,000,000									
OKS	400Vdc	6	L/R = 10	100	③	OKSCd	400Vdc	6	L/R = 10	100	③	
	250Vdc	15	L/R = 0	1,000	■		250Vdc	15	L/R = 0	1,000		
		3	L/R = 20	300,000	②				L/R = 20	300,000	②	
		1	L/R = 10	30,000					L/R = 10	30,000		
		0.1	L/R = 15	3,500,000	②				L/R = 0	1,000,000	②	
	120Vdc	30	L/R = 0	100	③ ■		120Vdc	20	L/R = 0	10,000	②	
		20	L/R = 0	10,000	② ■				L/R = 10	1,000		
		10	L/R = 10	1,000	■				L/R = 0	300,000	②	
		10	L/R = 0	300,000	②				L/R = 10	60,000		
		5	L/R = 10	60,000					L/R = 40	500,000		
2		L/R = 100	50,000		L/R = 10	1,000,000						
1		L/R = 40	500,000		48Vdc	10			L/R = 0	2,600,000		
1	L/R = 10	1,000,000		3		L/R = 30	400,000					
				1.5		L/R = 5	25,000,000					
48Vdc	10	L/R = 0	2,600,000		24Vdc	30	L/R = 50	200,000	④			
1.5	L/R = 5	25,000,000										
24Vdc	30	L/R = 50	200,000	④								

Notes:

- ② 2 contacts connected in series
- ③ 3 contacts connected in series
- ② 2 contacts connected in parallel
- ③ 3 contacts connected in parallel
- ④ 4 contacts connected in parallel

- Electric arc to core
- ◆ 3Hp motors
- Incandescent lamps

The breaking capacity is the level of current that the relay can break and handle without being destroyed, and without causing an electric arc of unacceptable and hazardous duration. Breaking capacity is also referred to as interrupting capacity, or rating.

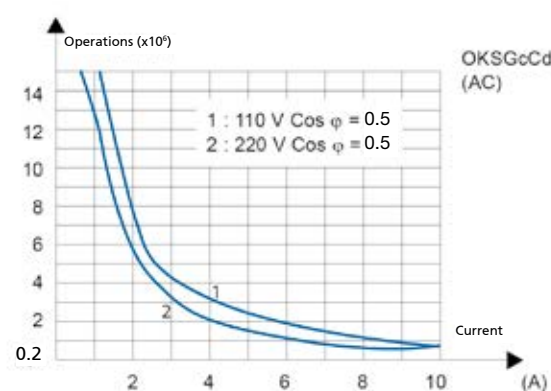
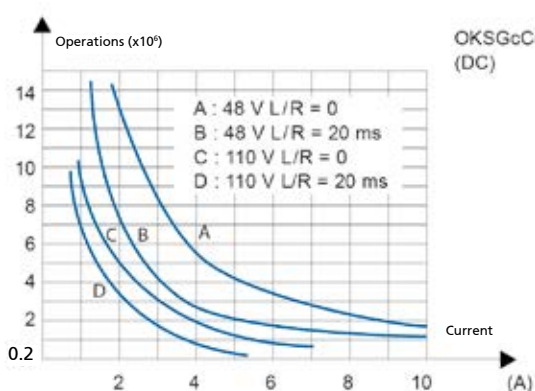
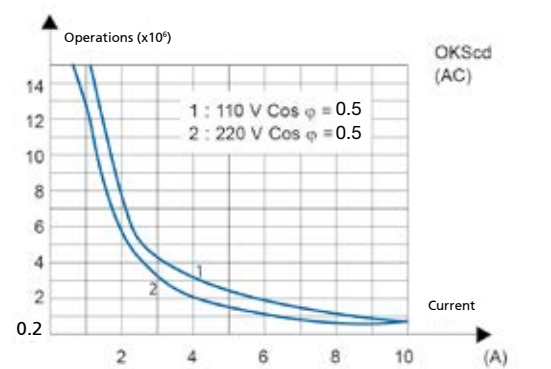
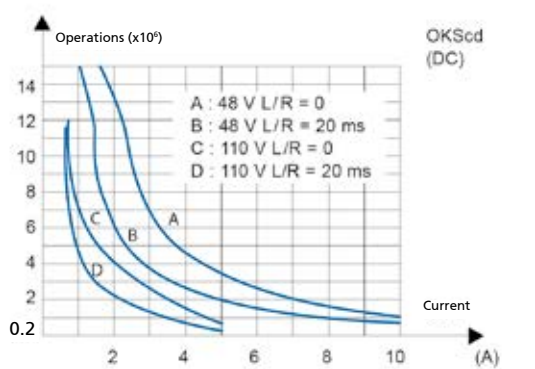
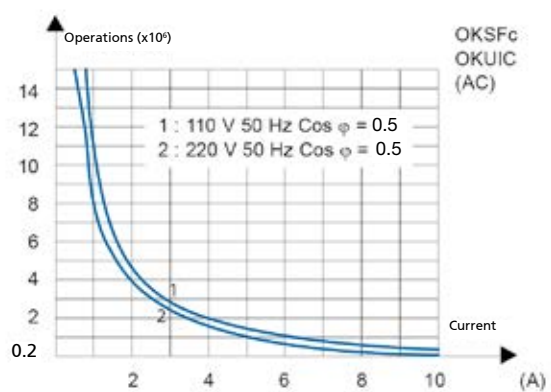
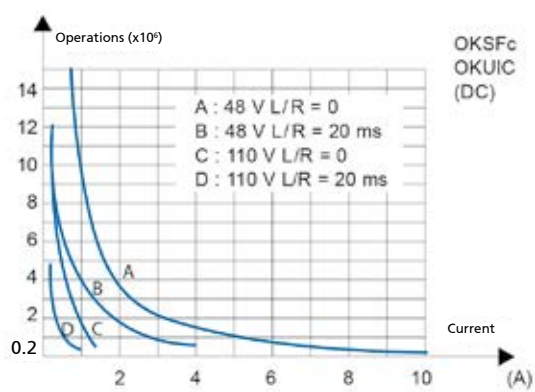
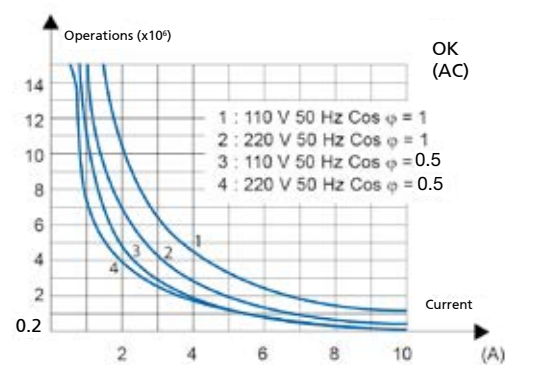
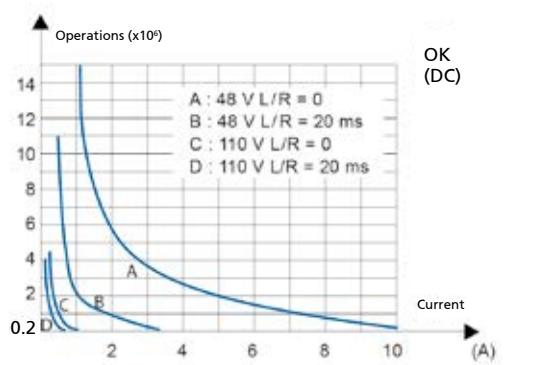

(1) Switching frequency 1,200 operations/hour, 50% cycle.

Sockets	OK series, 4 SPDT ⁽¹⁾
For wall or rail mounting	
Spring clamp, wall or DIN H35 rail mounting	PAIR160
Screw, wall or DIN H35 rail mounting	48BIP20-I DIN
Screw, wall mounting	48BL
Double faston, wall mounting	48L
For flush mounting	
Double faston (4.8 x 0.8 mm)	ADF2
Screw	43IL
For mounting on PCB	
	65

1) For version with 8 and 12 contacts, assume 2 and 3 sockets respectively for each relay. In this instance, the mounting distance between centres of the sockets must be 45mm. The ADF socket cannot be used. For more details, see specifications of mounting accessories.

Retaining clips – correspondence with sockets	OK series - $V_{supply} = V_{DC}$	OK series - $V_{supply} = V_{AC}$ OKUIC	OKUIC with LED / VR / DIODE
Number of clips per relay	1, 2 for version with 8-12 SPDT contacts	1, 2 for version with 8-12 SPDT contacts and OKUIC	2
SOCKET MODEL	CLIP MODEL		
For wall or rail mounting			
PAIR160, 48BIP20-I DIN, 48BL, 48L	RC48	RL48	RC48
For flush mounting			
ADF2	RC48	RL48	RC48
43IL ⁽¹⁾	RC43	RL43	RC43
For mounting on PCB			
65	RC43	RL43	RC43

(1) Insert the clip before fastening the socket on the panel.

Mounting tips

The preferred mounting position is on the wall, with the relay positioned horizontally in the reading direction on the nameplate. For correct use of the relays, they should be spaced apart by at least 5 mm in the horizontal direction and 20 mm in the vertical direction. This is to allow correct upward dissipation of the heat generated by the coil. Set these distances according to the socket used. Distances can be reduced depending on the environmental application conditions and on the relay duty cycle. For safe and secure operation, it is advisable to use retaining clips. No special maintenance is required. Condensation can form inside the relay when powered up and the outside ambient temperature is cold; this is quite normal and does not affect the operation of the relay. The plastic materials of the relay do not possess hygroscopic properties.

Notes

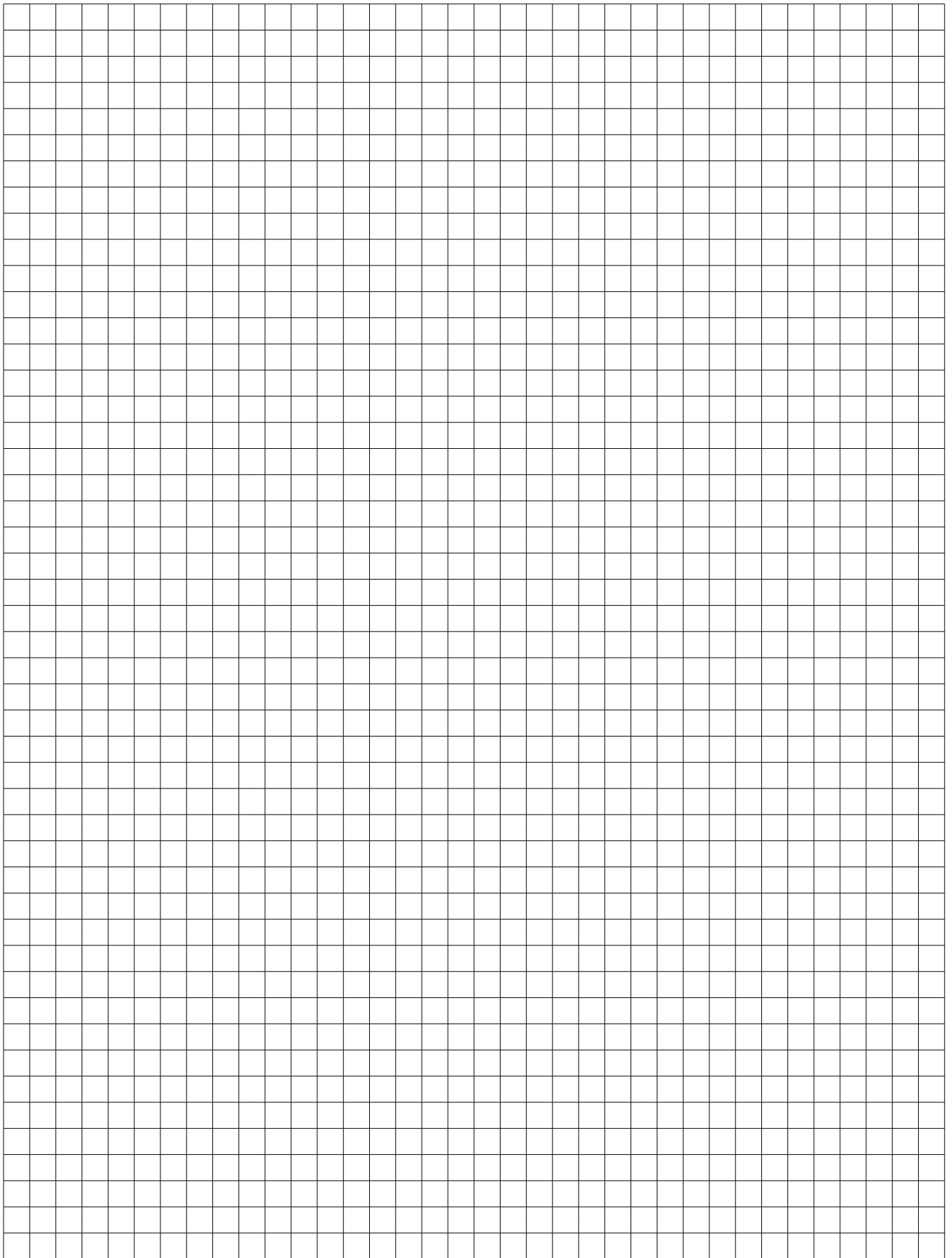

Fast-acting monostable relay 6 contacts

1.03

RV SERIES



OVERVIEW

- Plug-in monostable type fast-acting relay
- Ultra fast switching $\leq 6\text{ms}$, including bounces
- Solid and rugged construction
- Considerable long-life
- High electromagnetic interference immunity
- Separate arc breaking chambers
- Magnetic arc blow-out standard
- Independent and self-cleaning contacts
- Direct current operation
- Excellent shock and vibration resistance
- Wide range of sockets
- Retaining clip for secure locking of relay on socket
- Transparent cover, pull-out handle
- Positive mechanical keying for relay and socket

APPLICATIONS



Shipbuilding



Petroleum industry



Heavy industry



Power generation



Power distribution



Railway equipment

DESCRIPTION

The RV series is a range of 4 monostable relays able to guarantee high speed switching. These relays have 6 contacts rated 5 A, with different configurations including all normally open, or mixed (NO+NC). The relays are assembled with coils sized in such a way as to obtain magnetic flux of particularly high strength when powered up. Accordingly, optimization of the ferromagnetic circuit enables ultra fast switching of the contacts. The relay is immune to strong electromagnetic interference, typical of high voltage electricity distribution stations.

The self-cleaning contacts are independent, being anchored neither one to another nor to a common operating mechanism. Positioned in separate chambers, they enable better breaking of the arc. In addition, they are equipped with magnetic arc blow-out, guaranteeing a particularly efficient break of direct current loads. The common contact is mounted to a separate return device, consisting in a flexible blade designed to ensure uniformity of the pressures on break contacts.

Excellent electrical and mechanical performance levels allow the product to be used in the most demanding of sectors such as, for example, control and signalling functions in electricity generating stations, electrical transformer stations or heavy industry. The most common application is as a trip relay downstream of high voltage line protection systems.

The construction of the relays and careful choice of the materials are such that they ensure long life and considerable ruggedness even in harsh operating environments. The performance and reliability of the component have secured its approval with ENEL and other multi-utilities.

Models	Number of NO contacts	Number of NC contacts
RV LV16/1	6	0
RV LV16/2	4	2
RV LV16/3	3	3
RV LV16/5	2	4

FOR CONFIGURATION OF PRODUCT CODE, SEE "ORDERING SCHEME" TABLE

Coil data	
Nominal voltages Un	DC : 110-125
Max. consumption at Un (DC)	< 7W
Operating range	80...110% Un
Type of duty	Continuous
Drop-out voltage ⁽¹⁾	> 5% Un

(1) Limit value for supply voltage, expressed as % of the nominal value, beneath which the relay is certainly de-energized.

Contact data	RV LV16/1	RV LV16/2	RV LV16/3	RV LV16/5
Number and type	6 NA	4 NA + 2 NC	3 NA + 3 NC	2 NA + 4 NC
Current	5 A			
Nominal ⁽¹⁾	5 A			
Maximum peak (1 min) ⁽²⁾	10 A			
Maximum pulse (10 ms) ⁽²⁾	100 A			
Example of electrical life expectancy 1,800 operations / h	opening 0.3A - 110Vdc - L/R = 40ms : 10 ⁵ operations closing 30A - 110Vdc - L/R = 0ms : 2,000 operations			
Minimum load	500mW (20V, 20mA)			
Standard contacts	100mW (10V, 5mA)			
Gold-plated contact ⁽³⁾	250 Vdc / 350 Vac			
Maximum breaking voltages	AgCu			
Contact material	≤ 6			
Operating time at Un (ms) ⁽⁴⁾	≤ 6			
Pick-up (NO contact closing / NC contact opening)	≤ 6			

(1) Nominal current: on all contacts simultaneously, reduction of 30%.

(2) The max. peak and pulse currents are those currents that can be handled, for a specified time, by the contact. They do not refer to steady or interrupted currents.

(3) Specifications of contacts on new relay

a) Plating material: gold-nickel alloy (>6μ)

b) When the gold-plated contact is subject to heavy loads, it will be degraded on the surface. In such case, the characteristics of the standard contact should be taken into consideration. This does not impair relay operation.

(4) Unless specified otherwise, the operating time signifies until stabilization of the contact (including bounces).

Insulation	
Insulation resistance (at 500Vdc)	> 1,000 MΩ
between electrically independent circuits and between these circuits and ground	> 1,000 MΩ
between open contact parts	> 1,000 MΩ
Withstand voltage at industrial frequency	2 kV (1 min) - 2.2kV (1 s)
between electrically independent circuits and between these circuits and ground	1 kV (1 min) - 1.1kV (1 s)
between open contact parts	2.5 kV (1 min) - 3kV (1 s)
between adjacent contacts	2.5 kV (1 min) - 3kV (1 s)
Impulse withstand voltage (1.2/50μs - 0.5J)	5 kV
between electrically independent circuits and between these circuits and ground	3 kV
between open contact parts	3 kV

Mechanical specifications	
Mechanical life expectancy	10 ⁶ operations
Maximum switching rate	900 operations/hour
Degree of protection (with relay mounted)	IP40
Dimensions (mm)	45x60x109 ⁽¹⁾
Weight (g)	~ 300

(1) Output terminals excluded.

Environmental specifications

Operating temperature	-10 to +55 °C
Storage and shipping temperature	-25 to +70 °C
Relative humidity	Standard: 75% RH, Tropicalized: 95% RH
Resistance to vibrations	5g - 10 to 55 Hz - 1 min.
Resistance to shock	20g - 11ms
Fire behaviour	V0

Standards and reference values

EN 61810-1, EN 61810-2, EN 61810-7 EN 60695-2-10 EN 50082-2 EN 60529	Electromechanical elementary relays Fire behaviour Electromagnetic compatibility Degree of protection provided by enclosures
---	---

Unless otherwise specified, products are designed and manufactured according to the requirements of the European and International standards indicated above. In accordance with EN 61810-1, all items of technical data are referred to ambient temperature 23 °C, atmospheric pressure 96kPa and 50% humidity. Tolerance for coil resistance, nominal electrical input and nominal power is ±7%.

Configurations - Options

P2	Tropicalization of the coil with epoxy resin for use with 95% RH (@ T 50 °C). This treatment also protects the coil against corrosion which could occur by combination of the humidity with certain chemical agents, such as those found in acid atmospheres (typical of geothermal power stations) or saline atmospheres.
P4GEO	Gold plating of contacts with gold-nickel alloy, thickness ≥ 6µ. This treatment ensures long-term capacity of the contact to conduct lower currents in harsh ambient conditions such as acid atmospheres (typical of geothermal power stations) or saline atmospheres.
P5GEO	P4GEO gold-plating of contacts + P2 coil tropicalization.

RV Ordering scheme

Product code	Number of contacts	Configuration A	Configuration B	Type of power supply	Nominal voltage (V)	Keying position ⁽²⁾
RVLV16/1	6 NO	1: Standard	0: Standard	C: Vdc	110 - 125	XXX
RVLV16/2	4 NO + 2 NC		2: P2			
RVLV16/3	3 NO + 3 NC		4: P4 GEO			
RVLV16/5	2 NO + 4 NC		5: P5 GEO			

Example	RVLV16/1	1	2	C	110	
	RVLV16/112-C110 : RV relay with 6 NO contacts, ENEL-approved according to LV16 specification, nominal voltage 110Vdc, P2 finish					
	RVLV16/5	1	0	C	110	
	RVLV16/510-C110 : RV relay with 2 NO contacts + 4 NC contacts, ENEL-approved according to LV16 specification, nominal voltage 110Vdc					

(1) This product is available only in the ENEL type-approved version, according to LV15/LV16 specification. The designation "LV16/x" contained in the product code identifies the type-approved model.

For a full list of ENEL compliant and type-approved products, refer to the dedicated catalogue "STATIONS SERIES - LV15-LV16-LV20".

(2) Optional value. The positive mechanical keying is applied according to the manufacturer's model.

Wiring diagram

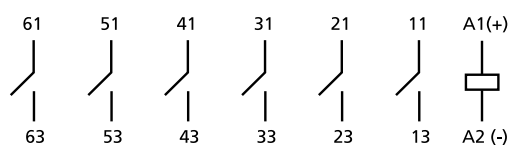

RV LV16/1

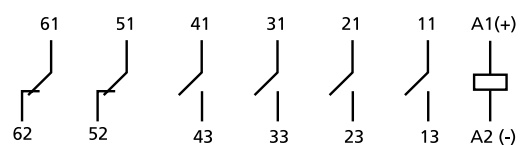

RV LV16/2

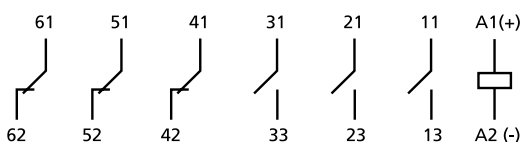

RV LV16/3

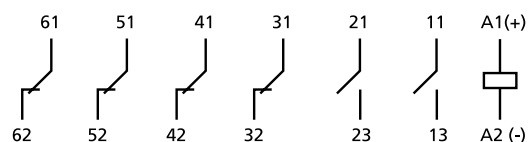

RV LV16/5

Dimensions

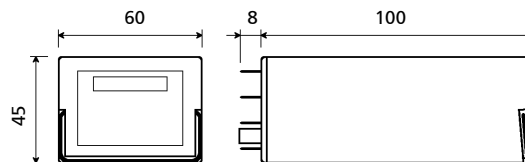

RV

Sockets and retaining clips	RV	
Number of terminals (standard dimensions 5x0.8mm)	14	Retaining clip
For wall or rail mounting		
Spring clamp, wall or DIN H35 rail mounting	PAIR240	RL48
Screw, wall or DIN H35 rail mounting	78BIP20-I DIN	RL48
Screw, wall mounting	78BL	RL48
Double faston, wall mounting	78L	RL48
For flush mounting		
Double faston (4.8 x 0.8 mm)	ADF3	RL48
Screw	73IL ⁽¹⁾	RL43

(1) Insert the clip before fastening the socket on the panel.
For more details, see specifications of mounting accessories.

Mounting tips

The preferred mounting position is on the wall, with the relay positioned horizontally in the reading direction on the nameplate. For correct use of the relays, they should be spaced apart by at least 5 mm in the horizontal direction and 20 mm in the vertical direction. This is to allow correct upward dissipation of the heat generated by the coil. Set these distances according to the socket used. Distances can be reduced depending on the environmental application conditions and on the relay duty cycle.

For safe and secure operation, it is advisable to use retaining clips.

No special maintenance is required.

Condensation can form inside the relay when powered up and the outside ambient temperature is cold; this is quite normal and does not affect the operation of the relay. The plastic materials of the relay do not possess hygroscopic properties.

Instantaneous bistable (latching) relay - 4-8 contacts

1.04

OKBA SERIES



OVERVIEW

- Plug-in instantaneous bistable relay
- Solid and rugged construction
- Considerable long-life
- Automatic de-energization following operation, energy saving
- Magnetic holding action
- Patent operating mechanism, designed to ensure high contact pressure
- Magnetic arc blow-out standard
- Independent and self-cleaning contacts
- Pulsed or permanent power supply, a.c. or d.c.
- Excellent shock and vibration resistance
- Wide range of sockets
- Retaining clip for secure locking of relay on socket
- Transparent cover, pull-out handle
- Positive mechanical keying for relay and socket

APPLICATIONS



Shipbuilding



Petroleum industry



Heavy industry



Power generation



Power distribution



Railway equipment



Rolling stock

DESCRIPTION

OKBA bistable relay is electromechanical devices having two stable states controlled by two distinct power inputs. There are many possible applications: these relays are used mainly because they are able to maintain the status assumed after the last switching operation, even in event of a power outage occurring - in short, they have a guaranteed "memory" capability. Given their superior reliability and durability, these components are capable of filling roles that call for a high level of responsibility; in effect, they are used in environments where continuous duty is an essential requirement (e.g. electrical transformer stations and continuous cycle manufacturing processes).

OKBA relay is equipped with a mechanism (electronic or mechanical, depending on the model) that cuts off the power supply to the coil leads after the switching operation; this means that power consumption can be reduced to zero, while maintaining the required operating position. The OKBA has a common negative pole and it's configured with the two negative poles separate from one another, for greater flexibility of connection.

In this model the core of a monostable relay is replaced by a special element made of magnetic material, which magnetizes when the relay is operated. In the event of a power outage, the magnet is able to hold the contacts in the operating position with a force on the armature of 10N. The magnet is demagnetized by a de-energize winding, which generates a magnetic field opposite to that of the energize winding, and allows the relay contacts to return to their initial position. The release winding forms part of the same coil that incorporates the latch winding. Available in versions with 4 or 8 change-over contacts.

Like all AMRA relays, OKBA model is assembled, calibrated and tested, individually and manually, as part of a sequential manufacturing process in which each step of production is tested automatically during the course of the subsequent step.

Models	Number of contacts	Rolling stock application
OKBA	4	•
OKBA8	8	

FOR CONFIGURATION OF PRODUCT CODE, SEE "ORDERING SCHEME" TABLE

Coil data	
Nominal voltages Un ⁽¹⁾	
Max. consumption at Un ⁽²⁾ Version for rolling stock at Un ⁽²⁾	7W / VA (latch) 3.5W / VA (unlatch) ⁽³⁾ 12,5W (latch) 5,5W (unlatch)
Operating range Version for rolling stock	80...115% Un DC : 70...125% Un
Type of duty	

Minimum control pulse 100 ms.

(1) Other values on request.

(2) At the moment of the relay being switched. De-energization occurs after 100 ms approx. Power consumption with relay energized: OKBA = 0.6 W / VA.

(3) For versions with 8 contacts, double the value.

Contact data	
Number and type	4 SPDT, form C ⁽¹⁾
Current	Nominal ⁽²⁾ 10A Maximum peak (1 min) ⁽³⁾ 20 A Maximum pulse (10 ms) ⁽³⁾ 150 A
Example of electrical life expectancy ⁽⁴⁾	0.5A - 110Vdc - L/R = 40ms : 10 ⁵ operations, 900 operations / hour
Minimum load	Standard contacts 500mW (20V, 20mA) Gold-plated contacts P4GEO ⁽⁵⁾ 100mW (10V, 5mA)
Maximum breaking voltage	350 Vdc / 440 Vac
Contact material	AgCu
Operating time at Un (ms) ⁽⁶⁾	DC - AC
Pick-up (NO contact closing)	≤ 30
Drop-out (NC contact closing)	≤ 40

(1) Version with 8 SPDT contacts available.

(2) On all contacts simultaneously, reduction of 30%.

(3) The max. peak and pulse currents are those currents that can be handled, for a specified time, by the contact. They do not refer to steady or interrupted currents.

(4) For other values, see electrical life expectancy curves.

(5) Specifications of gold-plated contacts on new relay

a) Plating material: **P4 GEO**: gold-nickel alloy (>6μ)

b) When the gold-plated contact is subject to heavy loads, it will be degraded on the surface. In such case, the characteristics of the standard contact should be taken into consideration. This does not impair relay operation.

(6) Unless specified otherwise, the operating time signifies until stabilization of the contact (including bounces).

Insulation	
Insulation resistance (at 500Vdc) between electrically independent circuits and between these circuits and ground between open contact parts	> 1,000 MΩ > 1,000 MΩ
Withstand voltage at industrial frequency between electrically independent circuits and between these circuits and ground between open contact parts between adjacent contacts	2 kV (1 min.) - 2.2kV (1 s) 2 kV (1 min.) - 2.2kV (1 s) 2 kV (1 min.) - 2.2kV (1 s)
Impulse withstand voltage (1.2/50μs - 0.5J) between electrically independent circuits and between these circuits and ground between open contact parts	5 kV 5 kV

Mechanical specifications		OKBA	
Mechanical life expectancy		20x10 ⁶ operations	
Maximum switching rate	Mechanical	900 operations/hour	
Degree of protection (with relay mounted)		IP20	
		4 SPDT	8 SPDT
Dimensions (mm)		45x45x109 ⁽¹⁾	92x45x109 ⁽¹⁾
Weight (g)		~ 300	~ 620

(1) Output terminals excluded.

Environmental specifications		
Operating temperature	Standard	-10 to +55°C
	Version for railways, rolling stock	-25 to +70°C
Storage and shipping temperature		-25 to +70°C
Relative humidity		Standard: 75% RH - Tropicalized: 95% RH
Resistance to vibrations		1g - 10 to 50 Hz
Resistance to shock		3g
Fire behaviour		to EN 60695-2-10

Standards and reference values	
EN 61810-1, EN 61810-2, IEC 61810-7 EN 60695-2-10 EN 50082-2 EN 60529	Electromechanical elementary relays Fire behaviour Electromagnetic compatibility Degree of protection provided by enclosures

Unless otherwise specified, the products are designed and manufactured according to the requirements of the above-mentioned European and International standards. In accordance with EN 61810-1, all items of technical data are referred to ambient temperature 23 °C, atmospheric pressure 96kPa and 50% humidity. Tolerance for coil resistance, nominal electrical input and nominal power is ±7%.

Railways, rolling stock - Standards	
EN 60077 EN 50155 EN 61373 EN 45545-2 ASTM E162, E662	Electric equipment for rolling stock - General service conditions and general rules Electronic equipment used on rolling stock Shock and vibration tests, Cat 1, Class B Fire behaviour, Cat E10, Requirement R26, V0 Fire behaviour

Configurations - Options	
P2	Tropicalization of the coil with epoxy resin for use with 95% RH (@ T 50 °C). This treatment also protects the coil against corrosion which could occur by combination of the humidity with certain chemical agents, such as those found in acid atmospheres (typical of geothermal power stations) or saline atmospheres.
P4GEO	Gold plating of contacts with gold-nickel alloy, thickness ≥ 6μ. This treatment ensures long-term capacity of the contact to conduct lower currents in harsh ambient conditions such as acid atmospheres (typical of geothermal power stations) or saline atmospheres.
P5GEO	P4GEO gold-plating of contacts + P2 coil tropicalization.
P6GEO	P4GEO type gold-plating, but applied to contacts, contact terminals and output terminals + P2 coil tropicalization.
DIODE	Polarized component connected in parallel with the coil (type 1N4007 or BYW56 for rolling stock version) designed to suppress overvoltages generated by the coil when de-energized.
IP40	IP40 protection with "6" handle or closure with screws.
8 contacts	Version with 8 change-over contacts, obtained using 2 x 4 SPDT relay, coils connected in series.
LOW TEMPERATURE (OKBA, 4 SPDT only)	Minimum operating temperature -40 °C, only for Rolling stock version (option "L").



OKBA Ordering scheme

Product code	Number of contacts	Application ⁽¹⁾	Configuration A	Configuration B	Type of power supply	Nominal voltage (V) ⁽²⁾	Keying position ⁽³⁾
OKBA	4: SPDT ⁽⁴⁾ 8: 8 SPDT	E: Energy Railway Fixed Equipment R: Railway Rolling Stock	1: Standard 2: Diode //	0: Standard 2: P2 4: P4 GEO 5: P5 GEO 6: P6 GEO	C: Vdc A: Vac 50 Hz	024 - 036 - 048 072 - 096 - 110 125 - 127 - 132 144 - 220 - 230	XXX L: Low temperature

Example

OKBA		E	1	0	C	144	
OKBAE10-C144 - OKBA relay, ENERGY series, nominal voltage 144 Vdc							
OKBA	8	E	1	2	C	024	
OKBA8E12-C024 - OKBA relay, ENERGY series, nominal voltage 24 Vdc, equipped with 8 contacts and P2 finish (tropicalization of coil)							

(1) E = ENERGY: all applications, except for railways rolling stock.

Suitable on energy production, transport and distribution plants, railways fixed equipment, petrochemical and heavy industry.

R = RAILWAYS, ROLLING STOCK: Application on board rolling stock (rail-tram-trolley vehicles). Electrical characteristics according to EN60077.

Available also the product series:

RAILWAYS, FIXED EQUIPMENT: Approved and conforming relays and products to RFI (FS Group) specification no. RFI DPRIM STF IFS TE 143 A

For the list of RFI approved and conforming products, consult dedicated catalogue "RAILWAY SERIES - RFI APPROVED".

STATIONS: ENEL approved material meeting LV15/LV16 specifications.

For the list of ENEL approved and conforming products, consult the dedicated catalogue "STATIONS SERIES - LV15-LV16-LV20".

(2) Other values on request.

(3) Optional value. The positive mechanical keying is applied according to the manufacturer's model.

(4) For the standard version with 4 contacts, the field must be left empty.

Wiring diagram

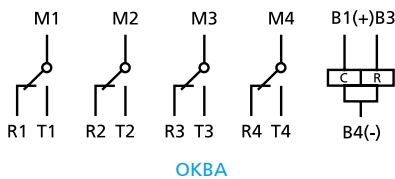

Dimensions

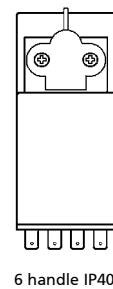
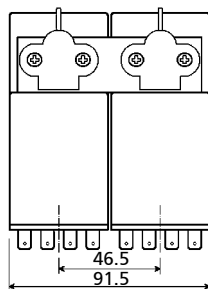
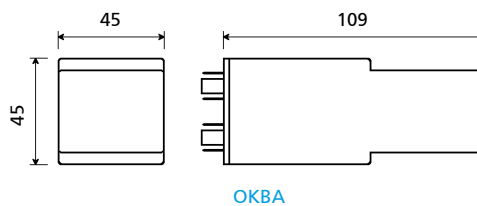

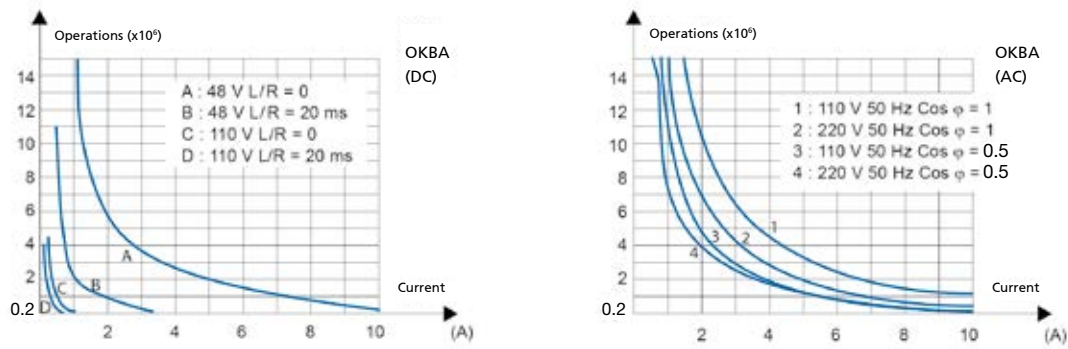

OKBA: other examples of electrical life expectancy available on the technical data sheet of the OK series relay (OKSFC model)

Sockets and retaining clips	OKBA, 4 SPDT ⁽¹⁾	
Number of terminals (standard dimensions 5x0.8mm)	16	Retaining clip ⁽²⁾
For wall or rail mounting		
Spring clamp, wall or DIN H35 rail mounting	PAIR160	RL48
Screw, wall or DIN H35 rail mounting	48BIP20-I DIN	RL48
Screw, wall mounting	48BL	RL48
Double faston, wall mounting	48L	RL48
For flush mounting		
Double faston (4.8 x 0.8 mm)	ADF2	RL48
Screw	43IL ⁽³⁾	RL43
For mounting on PCB		
	65	RL43

(1) For version with 8 contacts, assume 2 sockets respectively for each relay. In this instance, the mounting distance between centres of the sockets must be 45 mm.

The ADF socket cannot be used.

(2) Assume 2 clips for relays with 8 contacts.

(3) Insert the clip before fastening the socket to the panel.

For more details, see specifications of mounting accessories.

Mounting tips

The preferred mounting position is on the wall, with the relay positioned horizontally in the reading direction on the nameplate. These bistable relays are equipped with automatic de-energization. When mounting, accordingly, there is no need for them to be spaced apart as they do not draw power continuously and therefore will not overheat.

For safe and secure operation, it is advisable to use retaining clips.

No special maintenance is required.

Condensation can form inside the relay when powered up and the outside ambient temperature is cold; this is quite normal and does not affect the operation of the relay. The plastic materials of the relay do not possess hygroscopic properties.

Notes

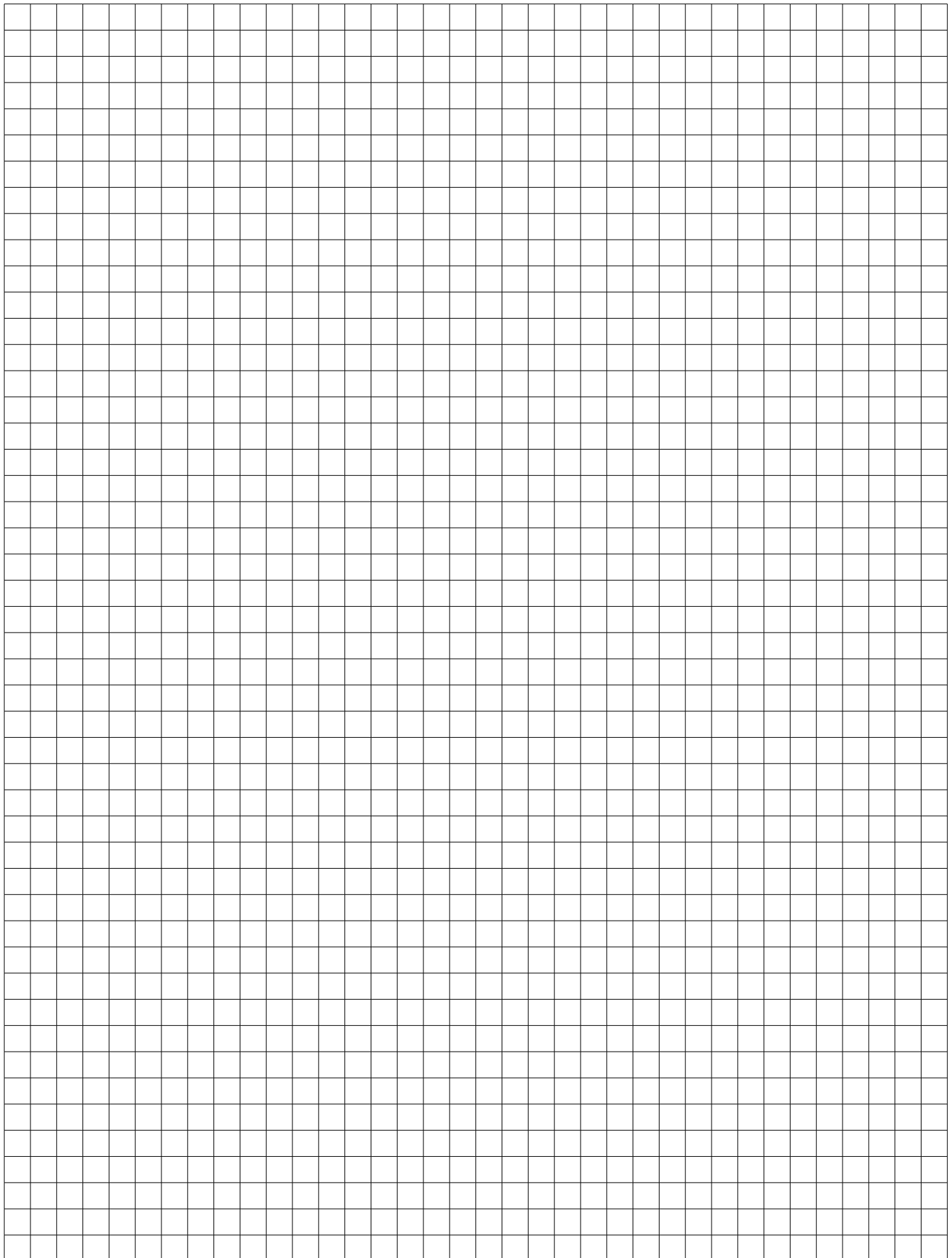

Monostable timer relay multiscale - 4 contacts

1.05

TM SERIES



EAC

OVERVIEW

- Plug-in relay with time delay on pick-up or on drop-out
- 4 time delay contacts or 2 time delay contacts + 2 instantaneous contacts
- Wide time setting range from 0.1s to 9 hours, great accuracy over the entire adjustment range
- High electromagnetic interference immunity
- Solid and rugged construction for heavy or intensive duty
- Considerable long-life
- Independent and self-cleaning contacts
- Magnetic arc blow-out standard
- Separate arc breaking chambers
- Excellent shock and vibration resistance
- Wide variety of configurations and customizations
- Option for use in geothermal sites available
- Wide range of sockets
- Retaining clip for secure locking of relay on socket
- Transparent cover, pull-out handle
- Positive mechanical keying for relay and socket

APPLICATIONS



Shipbuilding



Petroleum industry



Heavy industry



Power generation



Power distribution



Railway equipment



Rolling stock

DESCRIPTION

The TM series is a range of relays with electronic time delay on pick-up or drop-out, consisting of 8 models with 4 change-over contacts, from 5 to 10 A (nominal). They are obtained by assembling the electromechanical units of the POK or BIPOK series with a digital electronic circuit.

The electromechanical part features the reliability and ruggedness of relays belonging to the POK series, while the electronics offers high reliability thanks to the use of an electronic circuit requiring few components and to the careful choice of professional products.

With the same product it is possible to obtain switching times ranging from 0.1 second to over 9 hours, with the greatest of accuracy over the entire setting range. This is thanks to the fact that the relay has 16 intermediate scales, freely selectable by the user.

Switching time is adjustable by means of two dipswitches, 4- and 8-bit respectively, located on the front of the relay. The 4-bit dipswitch serves for selecting the most suitable intermediate scale, while the 8-bit dipswitch is used for precision selection of the switching time.

On request, the models are available with fixed switching time to avoid modifications to the time setting.

The electronic circuit is immune to high electromagnetic interference, typical of high voltage electricity distribution stations.

The construction of the relays and careful choice of the materials are such that they ensure long life and considerable ruggedness even in harsh operating environments and in the presence of strong temperature fluctuations.

Excellent electrical and mechanical performance levels allow the product to be used in the most demanding of sectors such as, for example, control and signalling functions in electricity generating stations, electrical transformer stations, rail transport or in industries with continuous production processes (chemical industry, petroleum industry, rolling mills, cement factories, etc.). A specific treatment (P5GEO or P6GEO) combining coil tropicalization with gold-plated contacts allows the use of these items in geothermal electric power stations, as relays for signalling functions, for controlling intermediate devices and for all non-power circuits.

Above all, the excellent ability to withstand shock and vibration allow their use on rolling stock.

Models	Function		Nominal current		Number of contacts		Rolling stock application
	Pick-up	Drop-out	5 A	10 A	Time-delayed	Instantaneous	
TM2E	•		•		2	2	•
TM4E	•		•		4	-	•
TMS2E	•			•	2	2	•
TMS4E	•			•	4	-	•
TM2R		•	•		2	2	•
TM4R		•	•		4	-	•
TMS2R		•		•	2	2	•
TMS4R		•		•	4	-	•

FOR CONFIGURATION OF PRODUCT CODE, SEE "ORDERING SCHEME" TABLE

Coil data	
Nominal voltages Un ⁽¹⁾	DC: 12-24-36-48-72-96-110-125-132-144-220 AC: 12-24-48-110-127-220-230
Max. consumption at Un (DC/AC)	4 W / 5 VA
Operating range ⁽¹⁾	80...115% Un
Rolling stock version ^{(2) (3)}	DC: 70...125% Un
Type of duty	Continuous
Drop-out voltage ⁽⁴⁾	DC: > 5% Un AC: > 15% Un

1. Other values on request. - 2. See "Ordering scheme" table for order code. - 3. For operating ranges different to that specified by EN60077, refer to table "Rolling stock versions - Special Ranges". - 4. Limit value for supply voltage, expressed as % of the nominal value, beneath which the relay is certainly de-energized.

Contact data	TM2E - TM2R	TM4E - TM4R	TMS2E - TMS2R	TMS4E - TMS4R
Number and type	2 + 2 instantaneous SPDT, form C	4 SPDT, form C	2 + 2 instantaneous SPDT, form C	4 SPDT, form C
Current				
Nominal ⁽¹⁾	5 A		10 A	
Maximum peak (1 min) ⁽²⁾	10 A		20 A	
Maximum pulse (10 ms) ⁽²⁾	100 A		150 A	
Example of electrical life expectancy ⁽³⁾	0.2 A – 110 Vdc – L/R = 40 ms : 10 ⁵ operations 0.7 A – 110 Vdc – L/R = 0 ms : 10 ⁵ operations		0.5 A – 110 Vdc – L/R = 40 ms : 10 ⁵ operations 1 A – 110 Vdc – L/R = 0 ms : 10 ⁵ operations	
Minimum load	Standard contacts 500 mW (20V, 20 mA)			
Gold-plated contact P4GEO ⁽⁴⁾	100 mW (10V, 5 mA)			
Gold-plated contact P8 ⁽⁴⁾	50 mW (5V, 5 mA)			
Maximum breaking voltage	250 Vdc / 350 Vac			
Contact material	AgCu		Ag / AgCu	
Operating time at Un (ms) ^{(5) (6)}	DC ⁽⁷⁾ – AC			
Pick-up (NO contact closing)	≤ 20 - ≤ 20			
Drop-out (NC contact closing)	≤ 15 - ≤ 20			

- On all contacts simultaneously, reduction of 30%.
- The max. peak and pulse currents are those currents that can be handled, for a specified time, by the contact. They do not refer to steady or interrupted currents.
- For other values, see electrical life expectancy curves.
- Specifications of contacts on new relay
 - Plating material: **P4 GEO**: gold-nickel alloy (>6μ) **P8**: gold-cobalt alloy (>5μ), knurled contact
 - When the gold-plated contact is subject to heavy loads, it will be degraded on the surface. In such case, the characteristics of the standard contact should be taken into consideration. This does not impair relay operation.
- Times for the instantaneous component of the relay.
- Unless specified otherwise, the operating time signifies until stabilization of the contact (including bounces). It should be added to the preset delay time.
- Addition of a flyback diode connected in parallel with the coil (DC version only) causes an increase in operating time when the relay drops out.

Insulation	
Insulation resistance (at 500Vdc)	
between electrically independent circuits and between these circuits and ground	> 1,000 MΩ
between open contact parts	> 1,000 MΩ
Withstand voltage at industrial frequency	
between electrically independent circuits and between these circuits and ground	2 kV (1 min) - 2.2 kV (1 s)
between open contact parts	1 kV (1 min) - 1.1 kV (1 s)
between adjacent contacts	2.5 kV (1 min) - 3 kV (1 s)
Withstand voltage at industrial frequency (1.2/50μs – 0.5J)	
between electrically independent circuits and between these circuits and ground	5 kV
between open contact parts	3 kV

Mechanical specifications



	Mechanical life	DC: 20 x 10 ⁶ AC: 10 x 10 ⁶ operations
Maximum switching rate	Mechanical life expectancy	3,600 operations / hour
	Degree of protection (with relay mounted)	IP40
	Dimensions (mm) ⁽¹⁾	40 x 50 x 97
	Weight (g)	~ 220

1. Output terminals excluded.

Environmental specifications



Operating temperature	Standard	-25° to +55°C
	Version for railway, rolling stock	-25° to +70°C
Storage and shipping temperature		-40° to +85°C
Relative humidity		Standard: 75% RH Tropicalized: 95% RH
Resistance to vibrations		5g - 10 to 55 Hz - 1 min
Resistance to shock		20g - 11 ms
Fire behaviour		V0

Standards and reference values



EN 61810-1, EN 61810-2, EN 61810-7 EN 61812-1 EN 60695-2-10 EN 50082-2 EN 60529	Electromechanical elementary relays Timer relays Fire behaviour Electromagnetic compatibility Degree of protection provided by enclosures
---	---

Unless otherwise specified, the products are designed and manufactured according to the requirements of the above-mentioned European and International standards. In accordance with EN 61810-1, all items of technical data are referred to ambient temperature 23 °C, atmospheric pressure 96kPa and 50% humidity. Tolerance for coil resistance, nominal electrical input and nominal power is ±7%.

Railways, rolling stock - Standards



EN 60077 EN 50155 EN 61373 EN 45545-2 ASTM E162, E662 CU TR 001/2011	Electric equipment for rolling stock. General service conditions and general rules Electronic equipment used on rolling stock Rolling stock equipment. Shock and vibration tests, Cat 1 Class B Fire behavior, Cat E10, Requirement R26, V0 Fire behaviour Safety of railway rolling stock - EAC certification
---	---

Railways, rolling stock – Special operating ranges ⁽¹⁾



Nominal voltage	Minimum pick-up voltage	Maximum operating voltage	Order symbol ⁽¹⁾
24 Vdc	18	33	Z01
24 Vdc	16	32	Z02
24 Vdc	16,8	32	Z03
72 Vdc	55	104	Z01
110 Vdc	77	144	Z01

(1) To request the special range, indicate the "Z0x" symbol in the "Keying position" field in the "Ordering scheme" table. The special range may be subject to operating specifications different from standard specifications. Please contact us for further information.



Configurations - Options

P2	Tropicalization of the coil with epoxy resin for use with 95% RH (@ T 50 °C). This treatment also protects the coil against corrosion which could occur by combination of the humidity with certain chemical agents, such as those found in acid atmospheres (typical of geothermal power stations) or saline atmospheres.
P4GEO	Gold plating of contacts with gold-nickel alloy, thickness $\geq 6\mu$. This treatment ensures long-term capacity of the contact to conduct lower currents in harsh ambient conditions such as acid atmospheres (typical of geothermal power stations) or saline atmospheres.
P5GEO	P4GEO gold-plating of contacts + P2 coil tropicalization.
P6GEO	P4GEO type gold-plating, but applied to contacts, contact terminals and output terminals + P2 coil tropicalization.
P7	AgCdO (silver cadmium oxide) contacts.
P8	Gold plating of contacts with gold-cobalt alloy, thickness $\geq 5\mu$, knurled fixed contact. This finish allows further improvement of the gold-plated contact performance compared to the treatment P4GEO.
LED	LED indicator showing presence of power supply, wired in parallel with the coil.
FLYBACK DIODE	Polarized component connected in parallel with the coil (type 1N4007 or BYW56 for rolling stock version) designed to suppress overvoltages generated by the coil when de-energized.
TRANSIL	Non-polarized component connected in parallel with the coil. Behaviour is similar to that of a varistor, with faster operating times.
LOW TEMPERATURE	Minimum operating temperature -50°C , only for rolling stock version (option "L").



TM Ordering scheme

Product code	Application ⁽¹⁾	Configuration A	Configuration B	Type of power supply	Nominal voltage (V) ⁽²⁾	Keying position ⁽³⁾ / options
TM2E TM4E TMS2E TMS4E TM2R TM4R TMS2R TMS4R	E: Energy Railway Fixed Equipment R: Railway Rolling Stock	1: Standard 2: Diode // 3: Varistor 4: Led 5: Diode // + Led 6: Varistor + Led 7: Transil 8: Transil + Led	0 : Standard 2: P2 4: P4 GEO 5: P5 GEO 6: P6 GEO 7: P7 8: P8	C: Vdc A: Vac 50 Hz H: Vac 60 Hz	012 - 024 - 036 048 - 072 - 096 100 - 110 - 125 127 - 132 - 144 220 - 230	XXX L = low temperature

Example	TMS2R	E	4	2	A	230	
	TMS2RE42-A230 - TMS2R relay, ENERGY series, nominal voltage 230 Vac, provided with LED, with P2 finish (tropicalized coil)						
	TM4R	R	1	8	C	024	L
	TM4RR18-C024 - TM4R relay, ROLLING STOCK series, nominal voltage 24 Vdc, with P8 finish (gold-plated contacts) and option "L" (low temp.)						

(1) **E = ENERGY:** all applications, except for railways rolling stock.

Suitable on energy production, transport and distribution plants, railways fixed equipment, petrochemical and heavy industry.

R = RAILWAYS, ROLLING STOCK: Application on board rolling stock (rail-tram-trolley vehicles). Electrical characteristics according to EN60077.

Availables also the product series:

RAILWAYS, FIXED EQUIPMENT: Approved and conforming relays and products to RFI (FS Group) specification no. RFI DPRIM STF IFS TE 143 A

For the list of RFI approved and conforming products, consult dedicated catalogue "RAILWAY SERIES – RFI APPROVED".

STATIONS: ENEL approved material meeting LV15/LV16 specifications.

For the list of ENEL approved and conforming products, consult the dedicated catalogue "STATIONS SERIES – LV15-LV16-LV20".

(2) Other values on request.

(3) Optional value. The positive mechanical keying is applied according to the manufacturer's model.

Wiring diagram

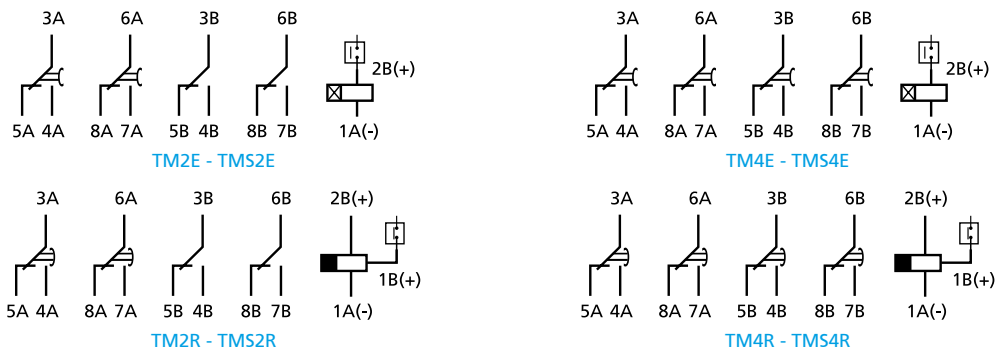

Relays with time delay on drop-out require an auxiliary power supply to ensure correct timing (terminal 2B)

Functional diagram

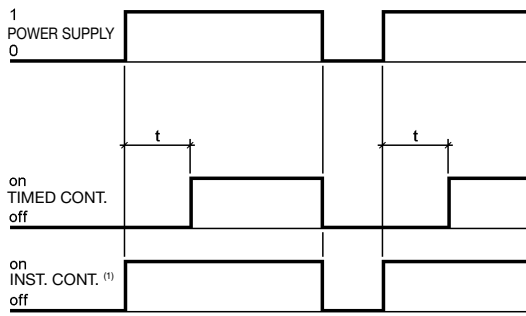

Time-delay on pick-up (version 2E, 4E)

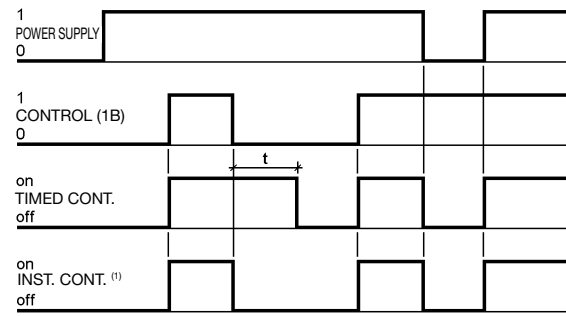

Time-delay on drop-out (version 2R, 4R)

⁽¹⁾ Instantaneous contacts are present only on versions "2E" and "2R"

Time delay – Switching time setting

Time setting	By means of DIP switches
Time setting range	100ms...32,768 s
Intermediate scale	16, from 1 second to 32,768 seconds
Resolution of switching time setting	1/256 of the selected scale
Accuracy, time-delay ⁽¹⁾	± 1% of the switching time ± 0.5% of the scale
Accuracy, repeatability	DC : ± 0.5% AC : ± 0.5% + 20 ms
Reset	< 100ms in time-delay phase < 400ms
Insensitivity to voltage drops	< 100 ms

(1) Additional error for drop-out versions: 100 ms

The switching time is adjustable via the dipswitches (4- and 8-bit respectively) located on the front of the relay, through which it is possible to obtain time delays from 100 ms to 32,768 seconds (about 9 hours).

To adjust the switching time, the first step is to adjust the intermediate scale T(s), by selecting one of the 16 available scales using the 4-bit dipswitch. The values available are given in table 1.

The value of the T(s) scale should be the next highest numerically than the value of the required switching time.

E.g. Switching time: 3600 seconds → intermediate scale to set: 4096 seconds

The T(s) scale is set by identifying the switches that add up to the ΣT value indicated in table 1, and positioning them at "1".

Next, proceed to set the switching time by means of the 8-bit dipswitch.

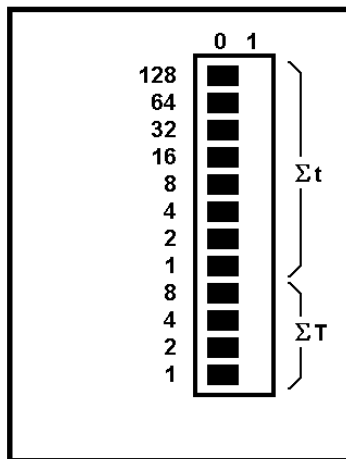

T(s)	ΣT	Switch reference			
		8	4	2	1
1	0	0	0	0	0
2	1	0	0	0	1
4	2	0	0	1	0
8	3	0	0	1	1
16	4	0	1	0	0
32	5	0	1	0	1
64	6	0	1	1	0
128	7	0	1	1	1
256	8	1	0	0	0
512	9	1	0	0	1
1024	10	1	0	1	0
2048	11	1	0	1	1
4096	12	1	1	0	0
8192	13	1	1	0	1
16384	14	1	1	1	0
32768	15	1	1	1	1

Table 1

The switching time is set by identifying the 16-bit dipswitches that add up to the Σt value, as calculated below, and positioning them at "1":

$$\Sigma t = \frac{t \times 256}{T} \text{ where } t(s) : \text{required switching time} \quad T(s) : \text{full scale time set previously}$$

Example: Relay with time delay 22sec. and full scale time 32sec.

For the full scale time of 32 s, select value 5 in the ΣT column (see table), then identify the switches corresponding to 4 and 1 (4+1=5) and position them at "1". For the delay time of 22 s, set an Σt value of 176 (i.e. 22x256/32), then identify the switches corresponding to 128, 32 and 16 (128+32+16=176) and position them at "1".

Dimensions

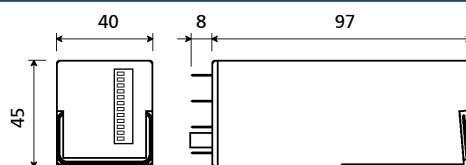

Electrical life expectancy ⁽¹⁾

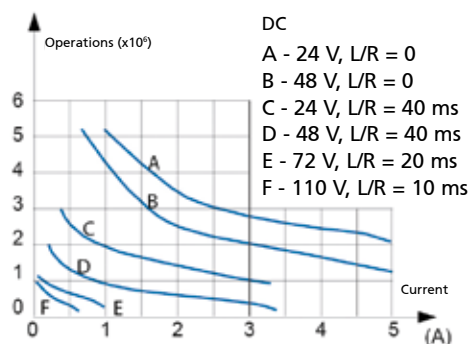

Some examples of electrical life expectancy
 48Vdc - 5 A - L/R 10 ms : 5 x 10⁵ operations
 80Vdc - 5 A - Resistive : 5 x 10⁵ operations
 110Vdc - 0.5 A - L/R = 10 ms : 5 x 10⁵ operations

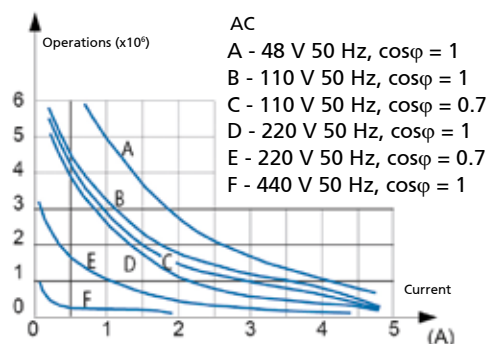

220Vdc - 0.2 A - L/R = 10 ms : 10⁵ operations
 110Vac - 5 A - Cosφ = 0.7 : 5 x 10⁵ operations
 220Vac - 3 A - Cosφ = 0.7 : 5 x 10⁵ operations
 440Vac - 0.2 A - Resistive : 5 x 10⁵ operations

(1) Switching frequency 1200 operations/hour, cycle 50%.

Sockets	
Number of terminals	16
For wall or rail mounting	
Spring clamp, wall or DIN H35 rail mounting	PAIR160
Screw, wall or DIN H35 rail mounting	48BIP20-I DIN
Screw, wall mounting	48BL
Double faston, wall mounting	48L
For flush mounting	
Double faston (4.8 x 0.8 mm)	ADF2
Screw	43IL
For mounting on PCB	
	65

For more details, see specifications of mounting accessories.

Retaining clips – correspondence with sockets	
Number of clips per relay	1, 2 for use on rolling stock
SOCKET MODEL	CLIP MODEL
For wall or rail mounting	
PAIR160, 48BIP20-I DIN, 48BL, 48L	RT48
For flush mounting	
ADF2	RT48
43IL ⁽¹⁾	RT43
For mounting on PCB	
65	RT43

(1) Insert the clip before fastening the socket on the panel.

Mounting tips

The preferred mounting position is on the wall, with the relay positioned horizontally in the reading direction on the nameplate. For correct use of the relays, they should be spaced apart by at least 5 mm in the horizontal direction and 20 mm in the vertical direction. This is to allow correct upward dissipation of the heat generated by the coil. Set these distances according to the socket used. Distances can be reduced depending on the environmental application conditions and on the relay duty cycle. For safe and secure operation, it is advisable to use retaining clips. No special maintenance is required. Condensation can form inside the relay when powered up and the outside ambient temperature is cold; this is quite normal and does not affect the operation of the relay. The plastic materials of the relay do not possess hygroscopic properties.

Timer relay - 4 contacts

Relay with time delay on drop-out, capacitor type

1.06

TOK · OKTF SERIES

OVERVIEW

- TOK: Relay with time delay on pick-up or on drop-out
- OKTF: Relay with fixed time delay on drop-out, without auxiliary power supply
- Wide range of time settings available
- Solid and rugged construction for heavy or intensive duty
- Very high electrical life expectancy and exceptional endurance
- Independent and self-cleaning contacts with high breaking capacity
- Patent operating mechanism, designed to ensure high contact pressure
- Magnetic arc blow-out for higher breaking capacity
- Excellent shock and vibration resistance
- Wide range of sockets
- Retaining clip for secure locking of relay on socket
- Transparent cover, pull-out handle
- Positive mechanical keying for relay and socket



OKTF
(with external capacitor)

TOKE

APPLICATIONS



Shipbuilding



Petroleum industry



Heavy industry



Power generation



Power distribution



Railway equipment



Rolling stock

DESCRIPTION

Relays of the TOK and OKTF series are monostable types with time delay, using 4 SPDT contacts. Manufactured following the same basic electromechanical design of the OK model, they embody all the features and benefits of this product. These models are suitable for use in the most demanding of sectors such as, for example, electricity generating stations, electrical transformer stations, industries using continuous production processes, and railways - fixed equipment and rolling stock alike. An ample clearance between open contact elements is instrumental in ensuring optimum performance when breaking high loads. The use of a magnetic arc blow-out helps to achieve a considerable increase in breaking capacity, even when handling highly inductive loads.

OKTF - OKSTf Series

The OKTF relay provides a time delay on drop-out, and uses 4 SPDT type contacts. The OKSTf model also offers magnetic arc blow-out, which provides an increase in breaking capacity.

There is no need for any auxiliary power supply to support the time delay function; this is provided by a capacitor connected in parallel with the coil. With the advantages of a precision engineered ferromagnetic circuit, and operational friction components reduced to the lowest level possible, there will be minimal variation of the time delay characteristic, even after millions and millions of operations. The relay is polarized. A resistor wired in series with the capacitor is designed to avoid current peaks.

For delays of duration less than 0.6 seconds, the capacitor is mounted internally of the relay. For delays of longer duration, the capacitor is mounted externally.

TOK Series

TOKe and TOKr relays provide time delays on pick-up and drop-out respectively, using 4 SPDT contacts. Intended originally for use in nuclear power plants, these relays are designed to guarantee particularly high reliability and superior strength. The time interval is adjusted by way of a potentiometer with flat head slotted screw drive, accessed from the top of the cover. A LED indicates energized status of the coil.

For further details of electromechanical construction, see chapter 1.2 "OK series".

Models	Function		Number of contacts	Magnetic arc blow-out	Adjustable time delay	Fixed time delay, capacitor controlled	Rolling stock application
	Pick-up	Drop-out					
TOKe	•		4	•	•		•
TOKr		•	4	•	•		•
OKTf		•	4			•	
OKSTf		•	4	•		•	

FOR CONFIGURATION OF PRODUCT CODE, SEE "ORDERING SCHEME" TABLE

Coil data	TOKe - TOKr	OKTf - OKSTf
Nominal voltages Un ⁽¹⁾	DC : 24-36-48-72-110-125-132-144-220 AC : 24-48-110-125-220-230	
Max. consumption at Un	4W / VA	
Operating range standard	80...115% Un	80...110% Un
Rolling stock version ^{(1) (2)}	DC: 70...125% Un	-
Type of duty	Continuous	
Drop-out voltage ⁽³⁾	> 5% Un	

(1) Other values on request.

(2) See "Ordering scheme" table for order code.

(3) Limit value for supply voltage, expressed as % of the nominal value, beneath which the relay is certainly de-energized.

Contact data	TOKe - TOKr - OKSTf	OKTf
Number and type	4 SPDT, form C	
Current	Nominal ⁽¹⁾	10A
	Maximum pulse (1 s) ⁽²⁾	20 A
	Maximum pulse (10 ms) ⁽²⁾	150 A
Example of electrical life expectancy ⁽³⁾ 1,800 operations / h	0.7 A – 132 Vdc – L/R = 40 ms : 10 ⁵ operations	0.5 A – 110 Vdc – L/R = 40 ms : 10 ⁵ operations
Minimum load	Standard contacts	500mW (20V, 20mA)
	Gold-plated contacts P4GEO ⁽⁴⁾	100mW (10V, 5mA)
Maximum breaking voltage	350 Vdc / 440 Vac	
Contact material	AgCu	
Operating time at Un (ms) ⁽⁵⁾	Pick-up (NO contact closing)	≤ 40 + e(t) ⁽⁶⁾
	Drop-out (NC contact closing)	-
		DC: ≤ 8 AC: ≤ 80

(1) Nominal current: on all contacts simultaneously.

(2) The max. peak and pulse currents are those currents that can be handled, for a specified time, by the contact. They do not refer to steady or interrupted currents.

(3) For other values, see electrical life expectancy curves.

(4) Specifications of gold-plated contacts on new relay

a) Plating material: **P4GEO**: gold-nickel alloy (>6µ).

b) When the gold-plated contact is subject to heavy loads, it will be degraded on the surface. In such case, the characteristics of the standard contact should be taken into consideration. This does not impair relay operation.

(5) Unless specified otherwise, the operating time signifies until stabilization of the contact (including bounces). It should be added to the preset delay time.

(6) e(t) = DC < 15% / AC < 20% of selected time delay.

Insulation	
Insulation resistance (at 500Vdc) between electrically independent circuits and between these circuits and ground between open contact parts	> 1,000 MΩ > 1,000 MΩ
Withstand voltage at industrial frequency between electrically independent circuits and between these circuits and ground between open contact parts between adjacent contacts	2 kV (1 min.) - 2.2kV (1 s) 2 kV (1 min.) - 2.2kV (1 s) 2 kV (1 min.) - 2.2kV (1 s)
Impulse withstand voltage (1.2/50µs - 0.5J) between electrically independent circuits and between these circuits and ground between open contact parts	5 kV 5 kV

Mechanical specifications



	Mechanical life expectancy	20x10 ⁶ operations
Maximum switching rate	Mechanical	3600 operations/hour
	Degree of protection (with relay mounted)	IP20
	Dimensions (mm)	45x45x109 ⁽¹⁾
	Weight (g)	~ 330

(1) Excluding output terminals. OKTf: dimension refers to version with internal capacitor. In the case of an external capacitor, the MAXIMUM dimensions are 90x45x134.

Environmental specifications



Operating temperature	Rolling stock version	-10 to + 55 °C -25 to + 70 °C
Storage and shipping temperature		-25 to + 85 °C
Relative humidity		Standard: 75% RH, Tropicalized : 95% RH
Resistance to vibrations		5g - 10 to 60 Hz - 1 min.
Resistance to shock		30g - 11ms
Fire behaviour		V0

Standards and reference values



EN 61810-1, EN 61810-2, EN 61810-7	Electromechanical elementary relays
EN 61812-1	Timer relays
EN 60695-2-10	Fire behaviour
EN 50082-2	Electromagnetic compatibility
EN 60529	Degree of protection provided by enclosures

Unless otherwise specified, the products are designed and manufactured according to the requirements of the above-mentioned European and International standards. In accordance with EN 61810-1, all items of technical data are referred to ambient temperature 23 °C, atmospheric pressure 96kPa and 50% humidity. Tolerance for coil resistance, nominal electrical input and nominal power is ±7%.

Railways, rolling stock - Standards



EN 60077	Electric equipment for rolling stock - General service conditions and general rules Electronic equipment used on rolling stock Shock and vibration tests, Cat 1, Class B Fire behaviour, Cat E10, Requirement R26, V0 Fire behaviour
EN 50155	
EN 61373	
EN 45545-2	
ASTM E162, E662	

Configurations - Options



P2	Tropicalization of coil with epoxy resin for use with 95% RH (@ T 50 °C). This treatment also protects the coil against corrosion which could occur by combination of the humidity with certain chemical agents, such as those found in acid atmospheres (typical of geothermal power stations) or saline atmospheres.
P4GEO	Gold plating of contacts with gold-nickel alloy, thickness ≥ 6μ. This treatment ensures long-term capacity of the contact to conduct lower currents in harsh ambient conditions such as acid atmospheres (typical of geothermal power stations) or saline atmospheres.
P5GEO	P4GEO gold-plating of contacts + P2 coil tropicalization.
P6GEO	P4GEO type gold-plating, but applied to contacts, contact terminals and output terminals + P2 coil tropicalization.
LED	LED indicator showing presence of power supply, wired in parallel with the coil.

**TOKx Ordering scheme**

Product code	Application ⁽¹⁾	Configuration A	Configuration B	Type of power supply	Nominal voltage (V) ⁽²⁾	Full scale time	Keying position ⁽³⁾
TOKe TOKr	E: Energy Railway Fixed Equipment R: Railway Rolling Stock	4: Led (fixed range)	0: Standard 2: P2 4: P4 GEO 5: P5 GEO 6: P6 GEO	C: Vdc ⁽⁴⁾ A: Vac 50 Hz H: Vac 60 Hz	024 - 036 - 048 072 - 110 - 125 132 - 144 - 220 230	01S: 1 s 02S: 2 s 04S: 4 s 08S: 8 s 16S: 16 s 32S: 32 s 01M: 1 min 02M: 2 min 04M: 4 min 08M: 8 min 16M: 16 min 32M: 32 min 64M: 64 min	XXX

Example

TOKe	E	4	0	C	110	04S	
TOKeE40-C110-04S - TOKe relay, ENERGY series, 110Vdc coil, full scale 4 seconds							
TOKr	R	4	4	C	024	08M	
TOKrR44-C024-08M - TOKr relay, ROLLING STOCK series, 24Vdc coil, full scale 8 minutes, with P4GEO finish (gold-plated contacts)							

(1) E = ENERGY: all applications, except for railways rolling stock.

Suitable on energy production, transport and distribution plants, railways fixed equipment, petrochemical and heavy industry.

R = RAILWAYS, ROLLING STOCK: Application on board rolling stock (rail-tram-trolley vehicles). Electrical characteristics according to EN60077.

Available also the product series:

RAILWAYS, FIXED EQUIPMENT: Approved and conforming relays and products to RFI (FS Group) specification no. RFI DPRIM STF IFS TE 143 A

For the list of RFI approved and conforming products, consult dedicated catalogue "RAILWAY SERIES – RFI APPROVED".

STATIONS: ENEL approved material meeting LV15/LV16 specifications.

For the list of ENEL approved and conforming products, consult the dedicated catalogue "STATIONS SERIES – LV15-LV16-LV20".

(2) Other values on request.

(3) Optional value. The positive mechanical keying is applied according to the manufacturer's model.

(4) Rolling Stock version, Vdc only available.

**OKTf Ordering scheme**

Product code	Application ⁽¹⁾	Configuration A	Configuration B	Type of power supply	Nominal voltage (V) ⁽²⁾	Operating time	Keying position ⁽³⁾
OKTf OKSTf	E: Energy Railway Fixed Equipment M: MMI	1: Standard	0: Standard 2: P2 4: P4 GEO 5: P5 GEO 6: P6 GEO	C: Vdc A: Vac 50 Hz H: Vac 60 Hz	024 - 048 - 110 115 - 125 - 220 - 230	See note ^(*)	XXX

Example

OKTf	E	1	0	C	110	30	
OKTfE10-C110-30 : OKTf standard relay, ENERGY series, 110Vdc coil, time delay 3 seconds							
OKTf	M	1	6	H	115	10	
OKTfM16-H115-10: OKTf standard relay, ITALIAN NAVY series, 115Vac 60 Hz coil, time delay 1 second, with P6 GEO finish							

(*) Selection of full scale time.

Fill in this field with the time delay. For available time delay values, consult the table "Range of times for OKTf relay".

Indicate the time expressed in seconds and tenths of one second, without separators, as in the following examples:

0.1 seconds: 01

0.5 seconds: 05

2.5 seconds: 25

Note: from 0.1s to 1s, with intermediate steps of 0.1s

from 1s to 7s, with steps of 0.5s

(1) E = ENERGY: all applications, except for railways rolling stock.

Suitable on energy production, transport and distribution plants, railways fixed equipment, petrochemical and heavy industry.

R = RAILWAYS, ROLLING STOCK: Application on board rolling stock (rail-tram-trolley vehicles). Electrical characteristics according to EN60077.

Available also the product series:

RAILWAYS, FIXED EQUIPMENT: Approved and conforming relays and products to RFI (FS Group) specification no. RFI DPRIM STF IFS TE 143 A

For the list of RFI approved and conforming products, consult dedicated catalogue "RAILWAY SERIES – RFI APPROVED".

STATIONS: ENEL approved material meeting LV15/LV16 specifications.

For the list of ENEL approved and conforming products, consult the dedicated catalogue "STATIONS SERIES – LV15-LV16-LV20".

MMI: Italian Navy specification. P6 GEO treatment as standard (see Configuration B).

(2) Other values on request.

(3) Optional value. The positive mechanical keying is applied according to the manufacturer's model.

Wiring diagram

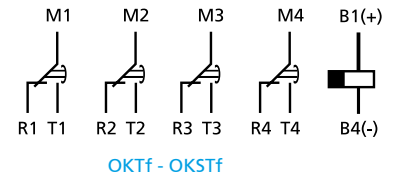
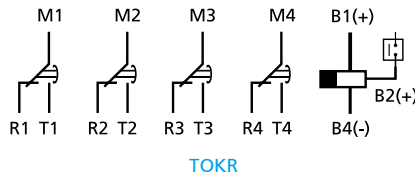
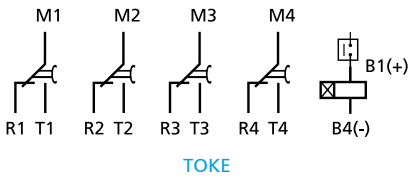

Functional diagram

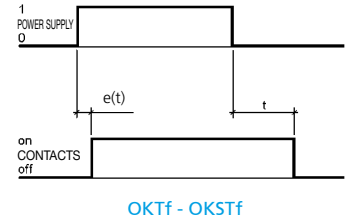
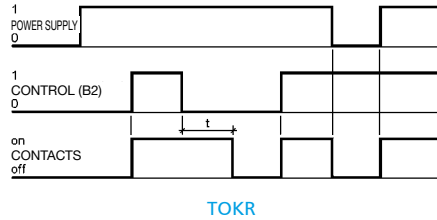
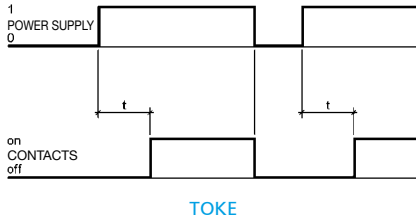

e(t): DC < 15% / AC < 20% of time t.

Time delay – Switching time setting	TOKE - TOKR	OKTf - OKSTf
Time setting	By way of potentiometer, with slotted head screw	Fixed time
Full scale times available	1-2-4-8-16-32 seconds, 1-2-4-8-16-32-64 minutes	from 0.1 to 7 seconds
Time setting range	10...100 % of full scale	-
Accuracy, setting (0.8... 1.1 Un, t=20°C)	± 5% of time delay	± 15% (Un) ⁽¹⁾
Accuracy, repeatability	DC: ± 0.5% / AC: ± 0.5% + 20ms	-
Reset	< 100ms - in time-delay phase < 1s	< 1s

(1): the time varies by the same percentage as the input voltage fluctuation, within limits of ± 10%.

Range of times for OKTf relay

The time delay is fixed. The minimum time delay possible is 0.1s. The maximum time delay possible is dependent on the relay input voltage.

	Nominal coil voltage DC/AC				
	24V	48V	110V	125V	220V
Maximum time with internal capacitor (s)	0.2	0.4	0.5	0.6	0.6
Maximum time with external capacitor (s)	2	6	6.5	6.5	7
Possible time delays	from 0.1s to 1s, with intermediate steps of 0.1s from 1s to 7s, with intermediate steps of 0.5s				

Dimensions

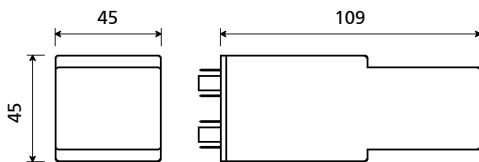

TOKE - TOKR
OKTf with internal capacitor

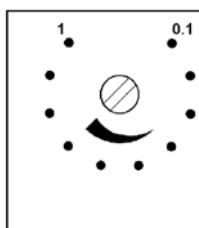

Time setting (TOK)
The scale shown on the relay
(0.1-1) is approximate

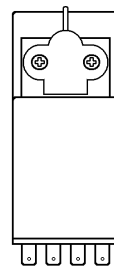

Finish for ROLLING STOCK
version (TOK)

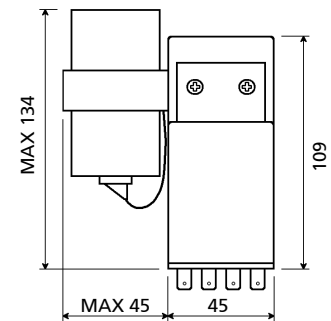

OKTf with external capacitor

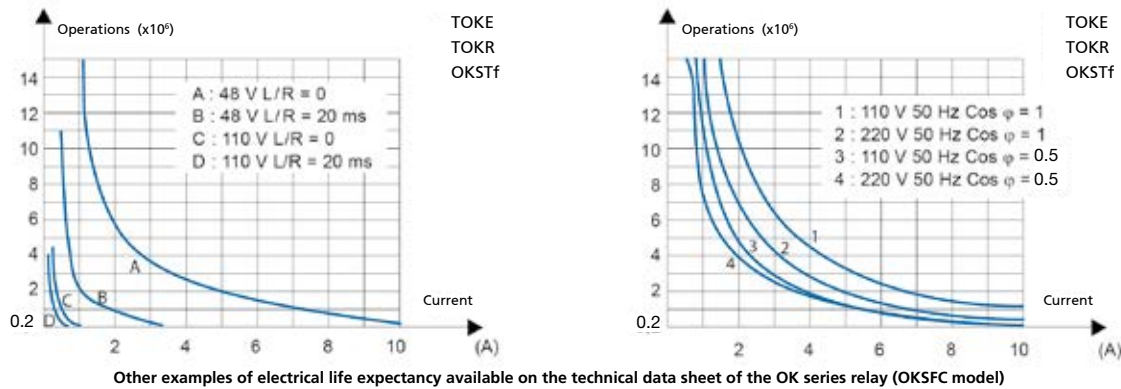
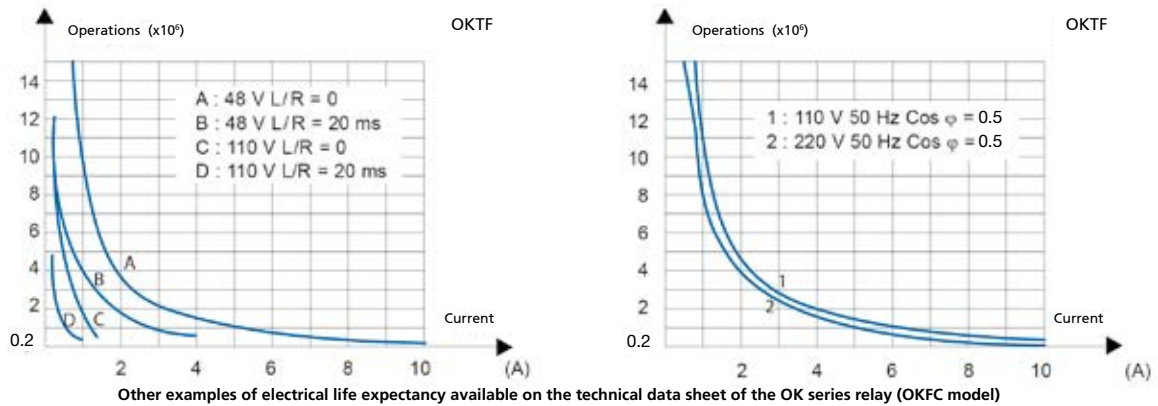

Sockets and retaining clips

Number of terminals (standard dimensions 5x0.8mm)	16	Retaining clip
For wall or rail mounting		
Spring clamp, wall or DIN H35 rail mounting	PAIR160	RL48
Screw, wall or DIN H35 rail mounting	48BIP20-I DIN	RL48
Screw, wall mounting	48BL	RL48
Double faston, wall mounting	48L	RL48
For flush mounting		
Double faston (4.8 x 0.8 mm)	ADF2	RL48
Screw	43IL ⁽¹⁾	RL43
For mounting on PCB	65	RL43

(1) Insert the clip before fastening the socket on the panel.
For more details, see specifications of mounting accessories.

Mounting tips

The preferred mounting position is on the wall, with the relay positioned horizontally in the reading direction on the nameplate. For correct use of the relays, they should be spaced apart by at least 5 mm in the horizontal direction and 20 mm in the vertical direction. This is to allow correct upward dissipation of the heat generated by the coil. Set these distances according to the socket used. Distances can be reduced depending on the environmental application conditions and on the relay duty cycle. For safe and secure operation, it is advisable to use retaining clips. No special maintenance is required. Condensation can form inside the relay when powered up and the outside ambient temperature is cold; this is quite normal and does not affect the operation of the relay. The plastic materials of the relay do not possess hygroscopic properties.

OKT · OKR SERIES

OVERVIEW

- Plug-in relay with time delay on pick-up or on drop-out
- Time delay setting from 0.1 second up to 1 hour
- Wide range of time settings available
- Operation using d.c. or a.c. power supply with a single product
- Solid and rugged construction for heavy or intensive duty
- Considerable long-life
- Separate arc breaking chambers
- Magnetic arc blow-out standard
- Independent and self-cleaning contacts
- Excellent shock and vibration resistance
- Wide range of sockets
- Retaining clip for secure locking of relay on socket
- Transparent cover, pull-out handle
- Positive mechanical keying for relay and socket



Time setting flat head slotted screw



Time setting knob

APPLICATIONS



Shipbuilding



Petroleum industry



Heavy industry



Power generation



Power distribution



Railway equipment



Rolling stock

DESCRIPTION

Relays of the OKR and OKT series are monostable types with time delay, using 4 or 3 SPDT contacts (depending on the model). Manufactured following the same basic electromechanical design of the POK model, they embody all the features and benefits of this product.

Excellent electrical and mechanical performance levels allow the product to be used in the most demanding of sectors such as, for example, control and signalling functions in electricity generating stations, electrical transformer stations, rail transport or in industries with continuous production processes (chemical industry, petroleum industry, rolling mills, cement factories, etc.). In particular, with their notable shock and vibration resistance, they are ideal for use on rolling stock.

The electronic timing circuit is designed using analog technology: by adopting a limited number of select components, the end product is guaranteed to meet high standards of quality and reliability.

OKRe and OKTa models offer time delay on pick-up, whereas OKRr and OKTr models offer time delay on drop-out.

In the case of the OKTr model, one of the 4 contacts must be connected to the power coil (see functional diagram). This obviates the need for connection of an auxiliary power supply to the relay, separate from the control. In this situation, the contacts available for switching purposes are 3 in number.

Models are available with different full scale time values (from 1 second up to 60 minutes), so as to offer a wide range of time delay settings. The full scale value is a fixed, factory set value determined as part of the manufacturing process. The end user can adjust the response time from a minimum 10% up to 100% of full scale with absolute ease, by way of the knob-operated or slotted screw-driven potentiometer located on the top of the relay housing. Power can be supplied to the relay from a d.c. or an a.c. source operating at 50 or 60 Hz.

For further details of electromechanical construction, see chapter 1.1 "POK series".

Models	Function		Number of time delayed contacts	Setting control		Rolling stock application	
	Pick-up	Drop-out		Knob	Flat head slotted screw		
OKTa	•		4	•	•	•	•
OKTr		•	3	•	•	•	•
OKRe	•		4	•	•	•	•
OKRr		•	4	•	•	•	•

FOR CONFIGURATION OF PRODUCT CODE, SEE "ORDERING SCHEME" TABLE

Coil data

Nominal voltages Un ⁽¹⁾	DC / AC: 24-36-48-72-110-125-132-144-220 -230
Max. consumption at Un (DC/AC)	4W / 5VA
Operating range ⁽¹⁾	80...115% Un
Rolling stock version ^{(2) (3)}	DC: 70...125% Un
Type of duty	Continuous
Drop-out voltage ⁽⁴⁾	> 5% Un

(1) Other values on request. Operation with d.c. or a.c. power supply.

(2) See "Ordering scheme" table for order code.

(3) For operating ranges different to that specified by EN60077, refer to table "Rolling stock versions - Special Ranges".

(4) Limit value for supply voltage, expressed as % of the nominal value, beneath which the relay is certainly de-energized.

Contact data

Contact data	OKTa	OKTr	OKRe - OKRr
Number and type	4 SPDT, form C	3 SPDT, form C	4 SPDT, form C
Current		5A	
Nominal ⁽¹⁾		5A	
Maximum peak (1 s) ⁽²⁾		10 A	
Maximum pulsed (10 ms) ⁽²⁾		100 A	
Example of electrical life expectancy ⁽³⁾	0.5A - 110Vdc - L/R = 40ms : 10 ⁵ operations, 1,800 operations/hour		
Minimum load		500mW (20V, 20mA)	
Standard contacts		500mW (20V, 20mA)	
Gold-plated contacts P4GEO ⁽⁴⁾		100mW (10V, 5mA)	
Gold-plated contacts P8 ⁽⁴⁾		50mW (5V, 5mA)	
Maximum breaking voltage		250 Vdc / 350 Vac	
Contact material		AgCu	
Switching time at Un (ms) ^{(5) (6)}		DC - AC	
Pick-up (NO contact closing)		≤ 20 - ≤ 20	
Drop-out (NC contact closing)		≤ 15 - ≤ 20	

(1) Nominal current: on all contacts simultaneously, reduction of 30%.

(2) The max. peak and pulse currents are those currents that can be handled, for a specified time, by the contact. They do not refer to steady or interrupted currents.

(3) 1,800 operations/hour - For other values, see electrical life expectancy curves.

(4) Specifications of gold-plated contacts on new relay

a) Plating material: **P4 GEO**: gold-nickel alloy (>6μ) **P8**: gold-cobalt alloy (>5μ), knurled contact

b) When the gold-plated contact is subject to heavy loads, it will be degraded on the surface. In this case, the characteristics of the standard contact should be taken into consideration. This does not impair relay operation.

(5) Unless specified otherwise, the operating time signifies until stabilization of the contact (including bounces). It should be added to the preset delay time.

(6) Addition of a flyback diode connected in parallel with the coil (DC version only) causes an increase in operating time when the relay drops out.

Insulation

Insulation resistance (at 500Vdc)	
between electrically independent circuits and between these circuits and ground	> 1,000 MΩ
between open contact parts	> 1,000 MΩ
Withstand voltage at industrial frequency	
between electrically independent circuits and between these circuits and ground	2 kV (1 min.) - 2.2kV (1 s)
between open contact parts	1 kV (1 min.) - 1.1kV (1 s)
between adjacent contacts	2.5 kV (1 min.) - 3kV (1 s)
Impulse withstand voltage (1.2/50μs - 0.5J)	
between electrically independent circuits and between these circuits and ground	5 kV
between open contact parts	3 kV

Mechanical specifications

	Mechanical life expectancy	20x10 ⁶ operations
Maximum switching rate	Mechanical	3600 operations/hour
	Degree of protection (with relay mounted)	IP40
	Dimensions (mm)	40x45x97 ⁽¹⁾
	Weight (g)	~ 220

(1) Excluding output terminals and adjuster knob, if specified.

Environmental specifications

Operating temperature	Standard	-10 to +55 °C
	Version for rolling stock	-25 to +70 °C
Storage and shipping temperature		-25 to +85 °C
Relative humidity		Standard: 75% RH, Tropicalized: 95% RH
Resistance to vibrations		5g - 10 to 55 Hz - 1 min.
Resistance to shock		20g - 11ms
Fire behaviour		V0

Standards and reference values

EN 61810-1, EN 61810-2, EN 61810-7 EN 61812-1 EN 60695-2-10 EN 50082-2 EN 60529	Electromechanical elementary relays Timer relays Fire behaviour Electromagnetic compatibility Degree of protection provided by enclosures
---	---

Unless otherwise specified, the products are designed and manufactured according to the requirements of the above-mentioned European and International standards. In accordance with EN 61810-1, all items of technical data are referred to ambient temperature 23 °C, atmospheric pressure 96kPa and 50% humidity. Tolerance for coil resistance, nominal electrical input and nominal power is $\pm 7\%$.

Railways, rolling stock - Standards

EN 60077 EN 50155 EN 61373 EN 45545-2 ASTM E162, E662	Electric equipment for rolling stock - General service conditions and general rules Electronic equipment used on rolling stock Shock and vibration tests, Cat 1, Class B Fire behaviour, Cat E10, Requirement R26, V0 Fire behaviour
---	--

Railways, rolling stock – Special operating ranges

Nominal voltage	Minimum pick-up voltage	Maximum operating voltage	Order symbol ⁽¹⁾
24 Vdc	18	33	Z01
72 Vdc	55	104	Z01
110 Vdc	77	140	Z01
128 Vdc	85	155	Z01

(1) To order the relay with the special operating range, indicate the "Z0x" symbol in the "Keying position" field of the ordering scheme. The special range may be subject to operating specifications different from standard specifications. Please contact us for further information.

Configurations - Options

P2	Tropicalization of coil with epoxy resin for use with 95% RH (@ T 50 °C). This treatment also protects the coil against corrosion which could occur by the combination of humidity with certain chemical agents, such as those found in acid atmospheres (typical of geothermal power stations) or saline atmospheres.
P4GEO	Gold plating of contacts with gold-nickel alloy, thickness $\geq 6\mu$. This treatment ensures long-term capacity of the contact to conduct lower currents in harsh ambient conditions such as acid atmospheres (typical of geothermal power stations) or saline atmospheres.
P5GEO	P4GEO type gold-plating + P2 coil tropicalization.
P6GEO	Gold-plating of contacts, contact terminals and output terminals + P2 coil tropicalization.
P7	Silver cadmium oxide contacts.
P8	Gold plating of contacts with gold-cobalt alloy, thickness $\geq 5\mu$, knurled fixed contact. This finish allows further improvement of the gold-plated contact performance compared to the treatment P4GEO.
LED	LED indicator showing presence of power supply, wired in parallel with the coil.
FLYBACK DIODE	Polarized component connected in parallel with the coil (type 1N4007 or BYW56 for rolling stock version) designed to suppress overvoltages generated by the coil when de-energized.
TRANSIL	Non-polarized component connected in parallel with the coil. Behaviour is similar to that of a varistor, with faster operating times.



Ordering scheme

Product code	Application ⁽¹⁾	Configuration A	Configuration B	Type of power supply	Nominal voltage (V) ⁽²⁾	Setting control	Full scale time	Keying position ⁽³⁾
OKRe OKTa OKRr OKTr	E: Energy Railway Fixed Equipment R: Railway Rolling Stock M: MMI	1: Standard 2: Diode // 3: Varistor 4: Led 5: Diode // + Led 6: Varistor + Led 7: Transil 8: Transil + Led	0: Standard 2: P2 4: P4 GEO 5: P5 GEO 6: P6 GEO 7: P7 8: P8	T: Vdc/ac C: Vdc ⁽⁴⁾	024 - 036 - 048 072 - 110 - 125 132 - 144 - 220 230	M: Knob C: Flat head slotted screw	01S: 1 s 05S: 5 s 10S: 10 s 15S: 15 s 30S: 30 s 01M: 1 min 02M: 2 min 05M: 5 min 10M: 10 min 15M: 15 min 30M: 30 min 60M: 60 min	XXX

Example	OKRe	E	1	0	T	110	M	05S		
	OKReE10-T110-M05S - OKRe relay, ENERGY series, nominal voltage 110Vdc, full scale 5 seconds, knob setting control									
	OKRr	R	5	0	C	072	C	30M	Z01	
	OKRrR50-C072-C30M-Z01 - OKRr relay, rolling stock series, nominal voltage 72Vdc, special range 55-104V, equipped with diode, led, full scale 30 minutes, slotted screw setting control									

(1) E = ENERGY: all applications, except for railways rolling stock.

Suitable on energy production, transport and distribution plants, railways fixed equipment, petrolchemical and heavy industry.

R = RAILWAYS, ROLLING STOCK: Application on board rolling stock (rail-tram-trolley vehicles). Electrical characteristics according to EN60077.

Available also the product series:

RAILWAYS, FIXED EQUIPMENT: Approved and conforming relays and products to RFI (FS Group) specification no. RFI DPRIM STF IFS TE 143 A

For the list of RFI approved and conforming products, consult dedicated catalogue "RAILWAY SERIES - RFI APPROVED".

STATIONS: ENEL approved material meeting LV15/LV16 specifications.

For the list of ENEL approved and conforming products, consult the dedicated catalogue "STATIONS SERIES - LV15-LV16-LV20".

MMI: Italian Navy specification. P6 GEO treatment as standard (see Configuration B). SLOTTED SCREW setting control only.

(2) Other values on request.

(3) Optional value. The positive mechanical keying is applied according to the manufacturer's model.

(4) Rolling Stock version, Vdc only available.

Wiring diagram

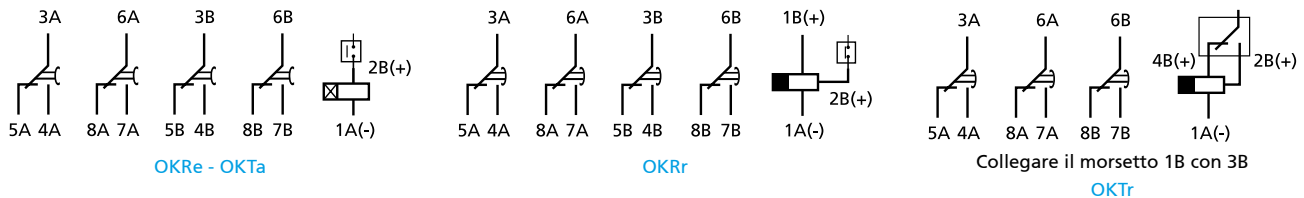

Functional diagram

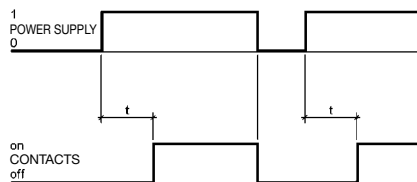

OKRe - OKTa

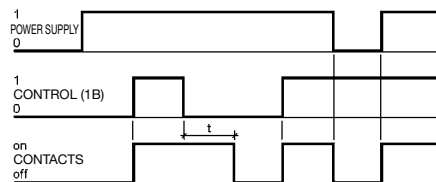

OKRr-OKTr



Time delay - Switching time setting

Time setting	By way of potentiometer, with knob or flat head slotted screw setting control
Full scale times available	1-5-10-15-30 seconds, 1-2-5-10-30-60 minutes
Time setting range	10...100 % of full scale
Accuracy, setting (0.8...1.1 Un, t=20°C)	± 10% of time delay
Accuracy, repeatability	± 0.5% (Vdc) - ± 0.5% + 20ms (Vac)
Reset	< 100ms - in time-delay phase < 1s

The setting scale shown on the front of the relay (0.1 ... 1) is approximate.

Dimensions

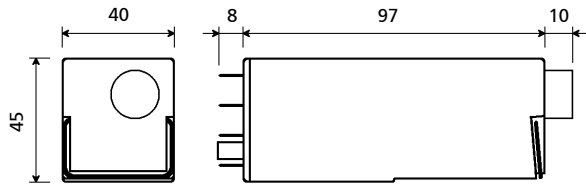

Relay with knob setting control

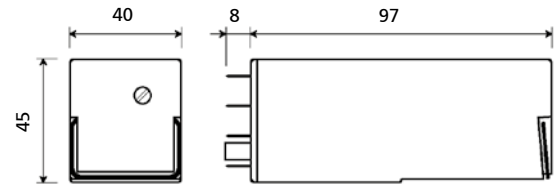

Relay with flat head slotted screw setting control

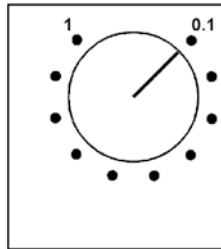

Knob setting control

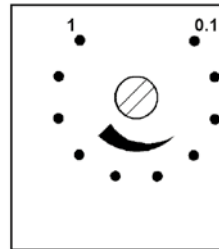

Flat head slotted screw setting control

The scale shown on the relay (0.1-1) is approximate

Electrical life expectancy

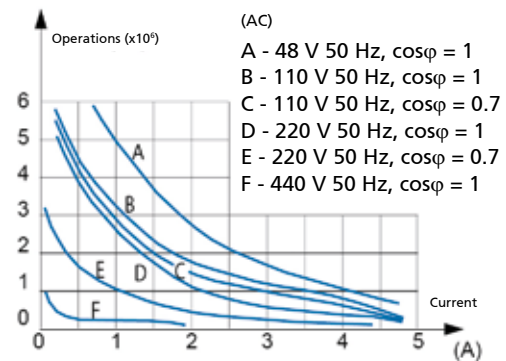
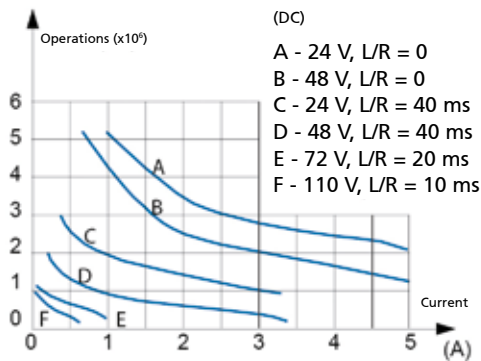

Some examples of electrical life expectancy
 48Vdc - 5 A - L/R = 10 ms : 5×10^5 operations
 80Vdc - 5 A - Resistive : 5×10^5 operations
 110Vdc - 0.5 A - L/R = 10 ms : 5×10^5 operations

220Vdc - 0.2 A - L/R = 10 ms : 10^5 operations
 110Vac - 5 A - $\cos\phi = 0.7$: 5×10^5 operations
 220Vac - 3 A - $\cos\phi = 0.7$: 5×10^5 operations
 440Vac - 0.2 A - Resistive : 5×10^5 operations

(1) Switching frequency 1,200 operations/hour, 50% cycle.

Sockets and retaining clips

Number of terminals (standard dimensions 5x0.8mm)	16	Retaining clip
For wall or rail mounting		
Spring clamp, wall or DIN H35 rail mounting	PAIR160	RC48
Screw, wall or DIN H35 rail mounting	48BIP20-I DIN	RC48
Screw, wall mounting	48BL	RC48
Double faston, wall mounting	48L	RC48
For flush mounting		
Double faston (4.8 x 0.8 mm)	ADF2	RC48
Screw	43IL ⁽¹⁾	RC43
For mounting on PCB		
	65	RC43

(1) Insert the clip before fastening the socket on the panel.
For more details, see specifications of mounting accessories.

Mounting tips

The preferred mounting position is on the wall, with the relay positioned horizontally in the reading direction on the nameplate. For correct use of the relays, they should be spaced apart by at least 5 mm in the horizontal direction and 20 mm in the vertical direction. This is to allow correct upward dissipation of the heat generated by the coil. Set these distances according to the socket used. Distances can be reduced depending on the environmental application conditions and on the relay duty cycle. For maximum reliability in operation, it is advisable to use retaining clips. No special maintenance is required. Condensation can form inside the relay when powered up and the outside ambient temperature is cold; this is quite normal and does not affect the operation of the relay. The plastic materials of the relay do not possess hygroscopic properties.

UTM SERIES



UTMR

OVERVIEW

- Static timer unit, operating on pick-up or drop-out
- Compact dimensions
- Timer control suitable for all AMRA relays
- Wide time setting range from 0.1s to 9 hours, great accuracy over the entire adjustment range
- Availability of 2 outputs: timed and instantaneous
- Led indicating power-up status
- Time setting with dipswitches
- High electromagnetic interference immunity
- Solid and rugged construction for heavy or intensive duty
- Wide range of sockets
- Retaining clip for secure locking of unit on socket
- Transparent cover

APPLICATIONS



Shipbuilding



Petroleum industry



Heavy industry



Power generation



Power distribution



Railway equipment



Rolling stock

DESCRIPTION

The UTM unit is a static timer module, designed for applications requiring a time delay activated on pick-up or on drop-out. Offered in 2 versions, these units can be used to control an external load, introducing a delay either on pick-up (UTME) or on drop-out (UTMR).

There are 2 outputs available: one timed, the other instantaneous, with maximum rated power 6W.

The UTM offers high reliability, thanks to the use of an electronic circuit requiring few components, and to the selection of professional grade products.

Switching times ranging from 0.1 second to over 9 hours are obtainable, with extreme accuracy guaranteed over the entire setting range. This is made possible as the module has 16 intermediate scales, freely selectable by the user.

Switching time is adjustable by means of two dipswitches, 4- and 8-bit respectively, located on the front of the relay.

The 4-bit dipswitch allows selection of the most suitable intermediate scale, whilst the 8-bit dipswitch is used for selection of the exact switching time.

The electronic circuit is immune to high electromagnetic interference, typical of high voltage electricity distribution stations. The construction of the module and careful choice of the materials are such as to ensure long life and considerable strength even in harsh operating environments and in the presence of strong temperature fluctuations.

In particular, with its notable shock and vibration resistance, the unit is ideal for use on rolling stock.

Models	Function		Output		Rolling stock application
	Pick-up	Drop-out	Instantaneous	Time-delayed	
UTME	•		•	•	•
UTMR		•	•	•	•

FOR CONFIGURATION OF PRODUCT CODE, SEE "ORDERING SCHEME" TABLE

Power supply data

Nominal voltages Un ⁽¹⁾	DC: 24-36-72-110-128
Max. consumption at Un (DC/AC)	0.6 W
Operating range ⁽¹⁾	80...115% Un
Rolling stock version ⁽²⁾	70...125% Un
Type of duty	Continuous
Maximum power at outputs	6 W (total)

1. Other values on request. - 2. See "Ordering scheme" table for order code.

Insulation

Insulation resistance (at 500Vdc) between electrically independent circuits and between these circuits and ground	> 1,000 MΩ
Withstand voltage at industrial frequency between electrically independent circuits and between these circuits and ground	2 kV (1 min) - 2.2 kV (1 s)
Impulse withstand voltage (1.2/50μs - 0.5J) between electrically independent circuits and between these circuits and ground	5 kV

Mechanical Specifications

Degree of protection (with unit mounted)	IP40
Dimensions (mm) ⁽¹⁾	40 x 40 x 50
Weight (g)	~ 60

1. Output terminals excluded.

Environmental specifications

Operating temperature	Standard	-25° to +55°C
	Version for railways, rolling stock	-25° to +70°C
Storage and shipping temperature		-40° to +85°C
Relative humidity		Standard: 75% RH
Resistance to vibrations		5g - 10 to 55 Hz - 1 min
Resistance to shock		20g - 11 ms
Fire behaviour		V0

Standards and reference values

EN 61812-1	Timer relays
EN 60695-2-10	Fire behaviour
EN 50082-2	Electromagnetic compatibility
EN 60529	Degree of protection provided by enclosures

Unless otherwise specified, products are designed and manufactured to the requirements of the European and International standards indicated above.
In accordance with EN 61810-1, all items of technical data are referred to ambient temperature 23 °C, atmospheric pressure 96kPa and 50% humidity.
Tolerance for coil resistance, nominal electrical input and nominal power is ±7%.

Railways, rolling stock - Standards

EN 60077	Electric equipment for rolling stock - General service conditions and general rules
EN 50155	Electronic equipment used on rolling stock
EN 61373	Shock and vibration tests, Cat 1, Class B
EN 45545-2	Fire behaviour, Cat E10, Requirement R26, V0
ASTM E162, E662	Fire behaviour

Configurations - Options

LOW TEMPERATURE	Minimum operating temperature -50°C, only for rolling stock version (option "L")
-----------------	--

UTM Ordering scheme

Product code	Application ⁽¹⁾	Configuration A	Configuration B	Type of power supply	Nominal voltage (V) ⁽²⁾	Keying position ⁽³⁾ / Options
UTME	E: Energy					XXX
UTMR	R: Railway Rolling Stock	1: Standard	0: Standard	C: Vdc	024 - 036 072 - 110	L = low temperature

Example	UTME	E	1	0	C	110		
	UTMEE10-C110 - UTME unit, ENERGY series, nominal voltage 110Vdc							
	UTMR	R	1	0	C	024	L	
	UTMRR-C024L - UTMR unit, ROLLING STOCK series, nominal voltage 24 Vdc, with option "L" (low temp.)							

(1) ENERGY: all applications except for railway.

RAILWAY, ROLLING STOCK: Application on board rolling stock (rail-tram-trolley vehicles). Electrical specifications according to EN60077.

(2) Other values on request.

(3) Optional value. Multiple selection possible. Positive mechanical keying is applied according to the manufacturer's model.

Timing - Time delay setting

Time setting	By means of dipperswitches
Time setting range	100ms...32,768 s
Intermediate scales	16, from 1 second to 32,768 seconds
Resolution of operating time setting	1/256 of selected scale
Accuracy, time-delay ⁽¹⁾	± 1% of the switching time ± 0.5% of the scale
Accuracy, repeatability	DC : ± 0.5% AC : ± 0.5% + 20 ms
Reset	< 100ms in time-delay phase < 400ms
Insensitivity to power losses	< 100 ms

(1) Additional error for drop-out versions: 100 ms

The switching time is adjustable by way of two dipperswitches (4- and 8-bit respectively) located on the front of the relay, which can be used to set time delays from 100 ms to 32,768 seconds (approximately 9 hours).

To determine the switching time, the first step is to adjust the intermediate scale T(s), by selecting one of the 16 available settings with the 4-bit dipperswitch. The values available are given in table 1.

The value of the T(s) scale should be the next highest numerically than the value of the required switching time.

E.g. Switching time: 3,600 seconds → intermediate scale setting: 4,096 seconds

The T(s) scale is set by identifying the switches that add up to the ΣT value indicated in table 1, and positioning them at "1".

Next, proceed to set the switching time by means of the 8-bit dipperswitch.

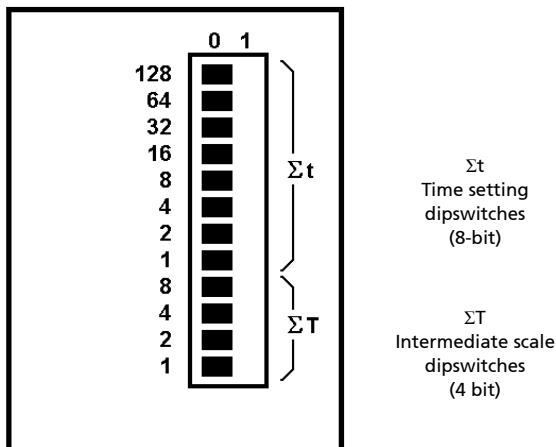

T(s)	ΣT	Switch reference			
		8	4	2	1
		Switch position			
1	0	0	0	0	0
2	1	0	0	0	1
4	2	0	0	1	0
8	3	0	0	1	1
16	4	0	1	0	0
32	5	0	1	0	1
64	6	0	1	1	0
128	7	0	1	1	1
256	8	1	0	0	0
512	9	1	0	0	1
1024	10	1	0	1	0
2048	11	1	0	1	1
4096	12	1	1	0	0
8192	13	1	1	0	1
16384	14	1	1	1	0
32768	15	1	1	1	1

Table 1

The switching time is set by identifying the 16-bit dipperswitches that add up to the Σt value, as calculated below, and positioning them at "1":

$$\Sigma t = \frac{t \times 256}{T} \quad \text{where } t(s) : \text{required switching time} \quad T(s) : \text{full scale time set previously}$$

Example: Relay with time delay 22 s. and full scale time 32 s.

For the full scale time of 32 s, select value 5 in the ΣT column (see table), then identify the switches corresponding to 4 and 1 (4+1=5) and position them at "1". For the delay time of 22 s, set an Σt value of 176 (i.e. 22x256/32), then identify the switches corresponding to 128, 32 and 16 (128+32+16=176) and position them at "1".

Wiring diagram

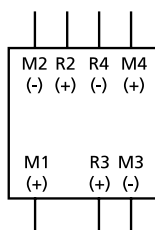

M3 - R3 = POWER SUPPLY
 M1 = CONTROL SIGNAL
 M4 - R4 = TIMED OUTPUT
 R2 - M2 = INSTANTANEOUS OUTPUT

Dimensions

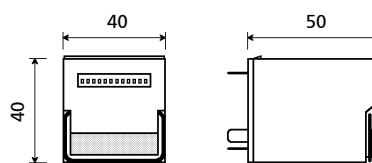

Functional diagram

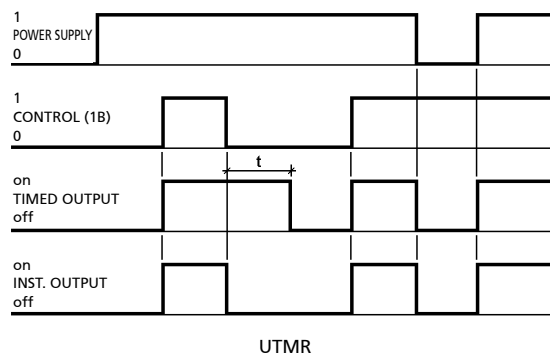
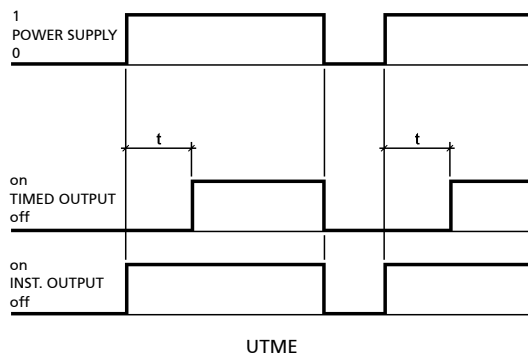

Sockets	
Number of terminals	16
For wall or rail mounting	
Spring clamp, wall or DIN H35 rail mounting	PAIR160
Screw, wall or DIN H35 rail mounting	48BIP20-I DIN
Screw, wall mounting	48BL
For flush mounting	
Screw	43IL
For mounting on PCB	
	65

For more details, see specifications of mounting accessories.

Retaining clips - correspondence with sockets

SOCKET MODEL	CLIP MODEL
Number of clips per relay	
For wall or rail mounting	
PAIR160, 48BIP20-I DIN, 48BL	RPB48
For flush mounting	
ADF2	RPB48
43IL ⁽¹⁾	RPB43
For mounting on PCB	
65	RPB43

(1) Insert the clip before fastening the socket on the panel.

Mounting tips

The preferred mounting position is on the wall, with the module positioned horizontally in the reading direction on the nameplate. For correct use, modules should be spaced apart by at least 5 mm in the horizontal direction and 20 mm in the vertical direction. This is to allow correct upward dissipation of the heat generated. Set these distances according to the socket used. Distances can be reduced depending on the environmental conditions during operation, and on the relay duty cycle. For safe and secure operation, it is advisable to use retaining clips. No special maintenance is required.

MOK-V2 SERIES



OVERVIEW

- MOK-V2 voltage threshold relay
- Pick-up and drop-out thresholds adjustable by way of two independent potentiometers
- Electronic circuit requiring no auxiliary power supply
- Solid and rugged construction for heavy or intensive duty
- Considerable long-life
- Excellent shock and vibration resistance
- Wide range of sockets
- Retaining clip for secure locking of relay on socket
- Positive mechanical keying for relay and socket

APPLICATIONS



Shipbuilding



Petroleum industry



Heavy industry



Power generation



Power distribution



Railway equipment



Rolling stock

DESCRIPTION

Products of the MOK series are measuring relays with adjustable hysteresis. The device measures an electrical quantity (voltage or current, depending on the model) registering in a monitored circuit; the contacts switch to 'make' status when this same quantity exceeds the pick-up threshold, selected by the user and expressed as a percentage of the nominal voltage/current. The relay reverts to 'break' status when the measured quantity drops below the drop-out threshold (also selected by the user), expressed as a percentage of the pick-up threshold. These models are suitable for the supervision and protection of electrical equipment used in the most demanding of sectors such as, for example, electricity generating stations, electrical transformer stations, industries using continuous production processes, and railways - fixed equipment and rolling stock alike.

MOK-V2 voltage threshold relay

The MOK-V2 is a measuring relay with two adjustable voltage thresholds: Pick-up voltage and Drop-out voltage. The setting, which is made by way of the potentiometers located on the top of the relay, pilots an electronic circuit that does not require an auxiliary power supply. The PICK-UP VOLTAGE can be set at between 60% and 120% of nominal voltage. The DROP-OUT VOLTAGE can be set at between 70% and 98% of the pick-up voltage. The MOK-V2 model is equipped with two change-over contacts rated 8A. In the case of the direct current version, the relay is equipped with a polarization diode that protects the circuits against an accidental inversion of polarities. Particularly suitable for monitoring battery voltages in the rail-tram-trolley vehicles sector.

Models	Function	Threshold setting		Number of contacts	Rolling stock application
		Pick-up	Drop-out		
MOK-V2	Voltage threshold relay	•	•	2	•

FOR CONFIGURATION OF PRODUCT CODE, SEE "ORDERING SCHEME" TABLE

Coil data	
Nominal voltages Un	DC : 24-48-36-72-110-125-132-144-220 AC : 24-48-110-125-220 ⁽¹⁾
Max. consumption at Un (DC/AC)	3.5 W / 4 VA
Maximum operating range	130% Un for 1 min.
Type of duty	Continuous

(1) Other values on request.

Operating thresholds	
Setting	By way of potentiometer, with flat head slotted screw
Pick-up threshold	$V(i) = 60\% - 120\% U_n$
Drop-out threshold	$V(r) 70\% - 98\% V(i)$
Accuracy, setting (t=20°C)	$\pm 1,5\% U_n$
Additional error (-40°C, +70°C)	+1 % Un
Accuracy, repeatability	1%

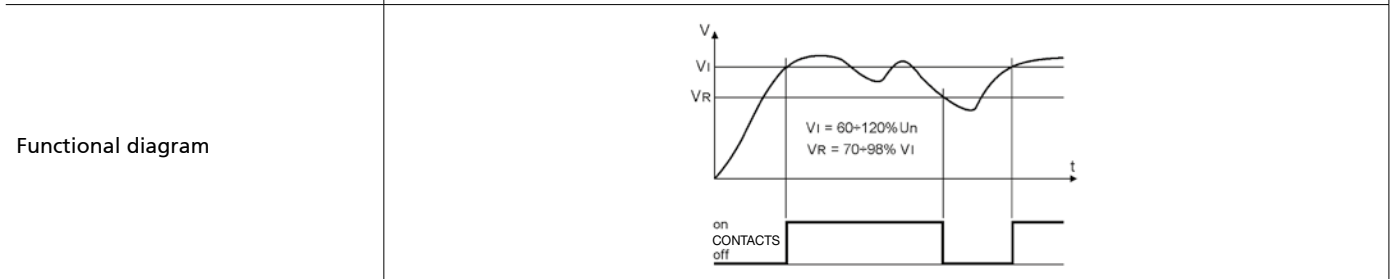

Important: the drop-out voltage V_r is expressed as a percentage of the pick-up thresholds.

Contact data	
Number and type	2 SPDT, form C
Current Nominal ⁽¹⁾	8 A
Example of electrical life expectancy ⁽²⁾	8 A – 250 Vac – $\cos\phi = 1$: 10^5 operations 0.2 A – 110 Vdc – L/R = 40 ms : 10^5 operations
Minimum load	100mW (10V, 5mA)
Maximum breaking voltage	150 Vdc / 400 Vac
Contact material	AgSnO
Operating time at Un (ms)	Pick-up (NO contact closing): ≤ 100 ms Drop-out (NC contact closing): ≤ 30 ms

(1) Nominal current: on all contacts simultaneously.

(2) 450 operations/hour.

Insulation

Insulation resistance (at 500Vdc)	
between electrically independent circuits and between these circuits and ground	> 1,000 MΩ
between open contact parts	> 1,000 MΩ
Withstand voltage at industrial frequency	
between electrically independent circuits and between these circuits and ground	2 kV (1 min.) - 2.2kV (1 s)
between open contact parts	1 kV (1 min.) - 1.1kV (1 s)
Impulse withstand voltage (1.2/50μs - 0.5J)	
between electrically independent circuits and between these circuits and ground	5 kV
between open contact parts	3 kV

Mechanical specifications

Mechanical life expectancy	10x10 ⁶ operations
Degree of protection (with relay mounted)	IP40
Dimensions (mm) ⁽¹⁾	48x48x118.5
Weight (g)	~ 180

(1) Excluding output terminals and adjuster knob, if specified.

Environmental specifications

Operating temperature	Rolling stock version	-25 to +55 °C
Storage and shipping temperature		-25 to +70 °C
Relative humidity		-50 to +85 °C
Resistance to vibrations		Standard: 75% RH, Tropicalized: 95% RH
Resistance to shock		5g - 10 to 55 Hz - 1min.
Fire behaviour		20g - 11ms
		V0 - to EN 60695-2-10

Standards and reference values

EN 61810-1, EN 61810-2, EN 61810-7 EN 60695-2-10 EN 50082-2 EN 60529	Electromechanical elementary relays Fire behaviour Electromagnetic compatibility Degree of protection provided by enclosures
---	---

Unless otherwise specified, the products are designed and manufactured according to the requirements of the above-mentioned European and International standards. In accordance with EN 61810-1, all items of technical data are referred to ambient temperature 23 °C, atmospheric pressure 96kPa and 50% humidity.

Railways, rolling stock - Standards

EN 60077 EN 50155 EN 61373 EN 45545-2 ASTM E162, E662	Electric equipment for rolling stock - General service conditions and general rules Electronic equipment used on rolling stock Shock and vibration tests, Cat 1, Class B Fire behaviour, Cat E10, Requirement R26, V0 Fire behaviour
---	--

Configurations - Options

P2	Tropicalization of coil with epoxy resin for use with 95% RH (@ T 50 °C). This treatment also protects the coil against corrosion which could occur by the combination of humidity with certain chemical agents, such as those found in acid or saline atmospheres.
LOW TEMPERATURE	Minimum operating temperature -40°C , only for rolling stock version (option "L")

Wiring diagram

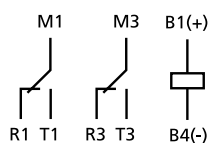

Selection of the range is made by connecting to the respective terminal.



MOK-x2 Ordering scheme

Product code	Application ⁽¹⁾	Configuration A	Configuration B	Type of power supply	Nominal voltage (V) ⁽²⁾	Keying position ⁽³⁾ / Options
MOK-V2	E: Energy Railway Fixed Equipment R: Railway Rolling Stock	1: Standard (fixed range)	0: Standard 2: P2	C: Vdc ⁽⁴⁾ A: Vac 50 Hz	024 - 036 - 048 072 - 110 - 125 128 - 132 - 144 220 - 230	XXX L = low temperature

Example

MOKV2	R	1	2	C	024	
MOKV2R12-C024 - MOK-V2 relay, ROLLING STOCK series, 24Vdc coil, with P2 coil tropicalization						

(1) E = ENERGY: all applications, except for railways rolling stock.

Suitable on energy production, transport and distribution plants, railways fixed equipment, petrochemical and heavy industry.

R = RAILWAYS, ROLLING STOCK: Application on board rolling stock (rail-tram-trolley vehicles). Electrical characteristics according to EN60077.

(2) Other values on request.

(3) Optional value. The positive mechanical keying is applied according to the manufacturer's model.

(4) Railways and Rolling Stock version, Vdc only available.

Dimensions

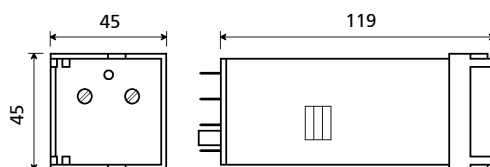

Sockets and retaining clips

Number of terminals (standard dimensions 5x0.8mm)	16	Retaining clip ⁽²⁾
For wall or rail mounting		
Spring clamp, wall or DIN H35 rail mounting	PAIR160	RM48
Screw, wall or DIN H35 rail mounting	48BIP20-I DIN	RM48
Screw, wall mounting	48BL	RM48
Double faston, wall mounting	48L	RM48
For flush mounting		
Double faston (4.8 x 0.8 mm)	ADF2	RM48
Screw	43IL ⁽¹⁾	RM43
For mounting on PCB	65	RM43

(1) Insert the clip before fastening the socket on the panel.

(2) Assume two clips for use on rolling stock.

For more details, see specifications of mounting accessories.

Mounting tips

The preferred mounting position is on the wall, with the relay positioned horizontally in the reading direction on the nameplate.

For correct use of the relays, they should be spaced apart by at least 5 mm in the horizontal direction and 20 mm in the vertical direction.

This is to allow correct upward dissipation of the heat generated by the coil. Set these distances according to the socket used.

Distances can be reduced depending on the environmental application conditions and on the relay duty cycle.

For safe and secure operation, it is advisable to use retaining clips.

No special maintenance is required.

Condensation can form inside the relay when powered up and the outside ambient temperature is cold; this is quite normal and does not affect the operation of the relay. The plastic materials of the relay do not possess hygroscopic properties.

OKPH MOK-PH2 SERIES



OKPh

OVERVIEW

- Plug-in relay for monitoring the cycle direction of three phase voltages
- 1 or 2 contacts available, according to model
- Fixed hysteresis cycle
- Monitoring of individual phase voltages
- Operation in alternating current at industrial frequency
- Solid and rugged construction for heavy or intensive duty
- Considerable long-life
- Excellent shock and vibration resistance
- Wide range of sockets
- Retaining clip for secure locking of relay on socket
- Positive mechanical keying for relay and socket

APPLICATIONS



Shipbuilding



Petroleum industry



Heavy industry



Power generation



Power distribution



Railway equipment

DESCRIPTION

Relays of the OKPh and MOK-Ph2 series are supervision devices for monitoring the directional sequence of phases or detecting the loss of one or more voltages in three phase systems. These components are used typically for detecting faults affecting either the power supply or the sequences of the individual phases. The supervision relay can identify undervoltages on one of the 3 phases, against a fixed threshold, or detect a phase break: this advantageously prevents the risk of three phase motors operating in single phase mode. In addition, monitoring of the correct R-S-T sequence enables permanent supervision of the status of power supplies to three-phase users, and the avoidance of dangerous wrong connections. These relays are connected directly to the 400Vac three-phase power line. When system under supervision is operating correctly, the relay contact remains closed. The OKPh relay detects the direction of rotation using passive electronic components (R and C) of high quality which, in combination with the superior reliability of the electromechanical section, allow these relays to cover key roles in the systems where they are installed. The MOK-PH2 relay is equipped with a completely static control circuit. The ultra high reliability and long life expectancy of these components allow their use in particularly demanding environments such as, for example, electricity generating stations, electrical transformer stations, and industries using continuous production processes, notably drilling and refining operations in the petrochemical sector.

Models	Function	Number of contacts	Rolling stock application
OKPh	Measuring relay for monitoring phase cycle direction	1 NO (Reed)	•
MOK-Ph2		2 SPDT	

FOR CONFIGURATION OF PRODUCT CODE, SEE "ORDERING SCHEME" TABLE

Coil data	OKPh	MOK-Ph2
Nominal voltages Un	AC : 100 - 110 - 220 - 380 - 400Vac 50 - 60 Hz	AC : 220 - 380Vac (45 - 65 Hz)
Max. consumption at Un	≤ 4.5 VA	
Operating range	80...120% Un	85...115% Un
Type of duty	Continuous	

(1) See "Ordering scheme" table for order code.

Fixed operating thresholds	OKPh	MOK-Ph2
Pick-up threshold	V > 0.80% Un	V > 0.85% Un
Drop-out threshold	V ≤ 50% Un on 3 phases	V ≤ 30% Un on single phase
Accuracy	± 5%	

Contact data	OKPh	MOK-Ph2
Number and type	1 NO, form A (REED)	2 SPDT, form C
Current Nominal ⁽¹⁾	4 A	3 A
Breaking capacity	120W (max.3A, max 300Vac)	-
Minimum load	100mW (10V, 5mA)	
Maximum breaking voltage	300 Vac	230 Vac
Contact material	Rh	-
Operating time at Un (ms) ⁽²⁾	-	
Pick-up (NO contact closing)	8 ms (at Un)	-

(1) Nominal current: on all contacts simultaneously.

(2) Unless specified otherwise, the operating time signifies until stabilization of the contact (including bounces).

Insulation	
Insulation resistance (at 500Vdc) between electrically independent circuits and between these circuits and ground	> 1,000 MΩ
between open contact parts	> 1,000 MΩ
Withstand voltage at industrial frequency between electrically independent circuits and between these circuits and ground	2 kV (1 min.) - 2.2kV (1 s)
between adjacent contacts	1 kV (1 min.) - 1.1kV (1 s)
Impulse withstand voltage (1.2/50µs - 0.5J) between electrically independent circuits and between these circuits and ground	5 kV
between open contact parts	2 kV

Mechanical specifications	OKPh	MOK-Ph2
Mechanical life expectancy	10 ⁷ operations	
Degree of protection (with relay mounted)	IP40	
Dimensions (mm)	45x45x109 ⁽¹⁾	45x45x109 ⁽¹⁾
Weight (g)	~ 280	~ 300

(1) Output terminals excluded.

Environmental specifications	OKPh	MOK-Ph2
Operating temperature	-25 to + 55 °C	-25 to + 55 °C
Rolling stock version	-25 to + 70 °C	-
Storage and shipping temperature	-40 to + 85 °C	-40 to + 70 °C
Relative humidity	Standard: 80% RH, Tropicalized: 95% RH	
Resistance to vibrations	5g - 10 to 55 Hz - 1min.	-
Resistance to shock	20g - 11ms	-
Fire behaviour	V0 - to EN 60695-2-10	

Standards and reference values

EN 61810-1, EN 61810-2, EN 61810-7
 EN 60695-2-10
 EN 50082-2
 EN 60529

Electromechanical elementary relays
 Fire behaviour
 Electromagnetic compatibility
 Degree of protection provided by enclosures

Unless otherwise specified, the products are designed and manufactured according to the requirements of the above-mentioned European and International standards. In accordance with EN 61810-1, all items of technical data are referred to ambient temperature 23 °C, atmospheric pressure 96kPa and 50% humidity.

Railways, rolling stock - Standards

EN 60077 EN 50155 EN 61373 EN 45545-2 ASTM E162, E662	Electric equipment for rolling stock - General service conditions and general rules Electronic equipment used on rolling stock Shock and vibration tests, Cat 1, Class B Fire behaviour, Cat E10, Requirement R26, V0 Fire behaviour
---	--

Configurations - Options

P2	Tropicalization of coil with epoxy resin for use with 95% RH (@ T 50 °C). This treatment also protects the coil against corrosion which could occur by combination of the humidity with certain chemical agents, such as those present in acid atmospheres (typical of geothermal power stations) or saline atmospheres.
----	--

OKPh - MOK-Ph2 Ordering scheme

Product code	Application ⁽¹⁾	Configuration A	Configuration B	Type of power supply	Nominal voltage (V) ⁽²⁾	Keying position ⁽³⁾
OKPh	E: Energy Railway Fixed Equipment R: Railway Rolling Stock	1: Standard (fixed range)	0: Standard 2: P2	A: Vac 50 Hz H: Vac 60 Hz	100 110 220 380 400	XXX
MOK-Ph2	E: Energy Railway Fixed Equipment			A: Vac (45 - 65Hz)	220 380	

Example	OKPh	R	1	2	H	220	
	OKPh-R12-H220 - OKPh relay, ROLLING STOCK series, 220 Vac 60Hz coil, with P2 tropicalization treatment						
	MOK-Ph2	E	1	0	A	380	
	MOK-Ph2E10-A380 - MOK-Ph2 relay, ENERGY series, 380Vac coil						

(1) E = ENERGY: all applications, except for railways rolling stock.

Suitable on energy production, transport and distribution plants, railways fixed equipment, petrochemical and heavy industry.

R = RAILWAYS, ROLLING STOCK: Application on board rolling stock (rail-tram-trolley vehicles). Electrical characteristics according to EN60077.

Available also the product series:

RAILWAYS, FIXED EQUIPMENT: Approved and conforming relays and products to RFI (FS Group) specification no. RFI DPRIM STF IFS TE 143 A

For the list of RFI approved and conforming products, consult dedicated catalogue "RAILWAY SERIES - RFI APPROVED".

STATIONS: ENEL approved material meeting LV15/LV16 specifications.

For the list of ENEL approved and conforming products, consult the dedicated catalogue "STATIONS SERIES - LV15-LV16-LV20".

(2) Optional value. The positive mechanical keying is applied according to the manufacturer's model.

Wiring diagram

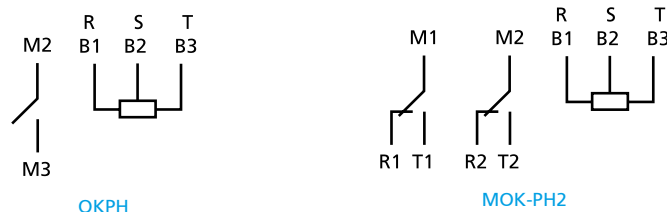

The OKTr relay requires connection of the 1B/R1 terminal with 3B/T1.

Dimensions

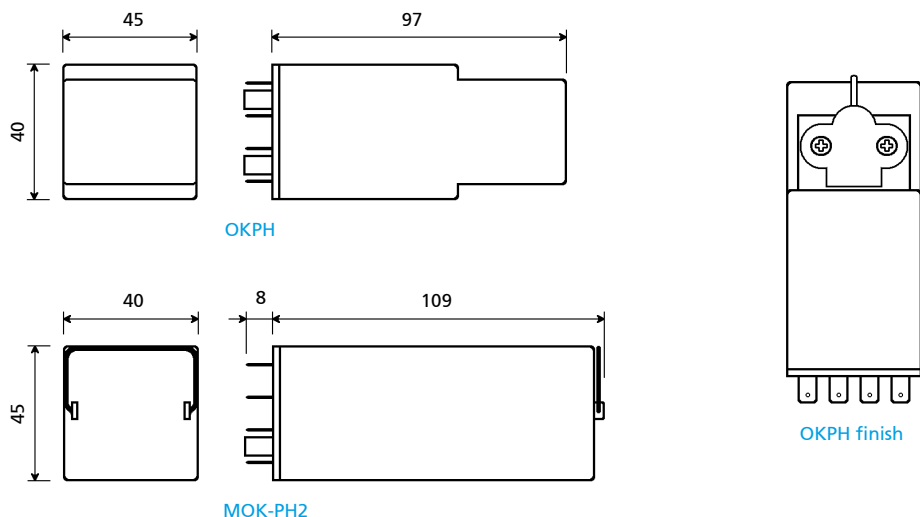

Sockets and retaining clips		OKPh	MOK-Ph2
Number of terminals (standard dimensions 5x0.8mm)	16	Retaining clip	Retaining clip
For wall or rail mounting			
Spring clamp, wall or DIN H35 rail mounting	PAIR160	RL48	RM48
Screw, wall or DIN H35 rail mounting	48BIP20-I DIN	RL48	RM48
Screw, wall mounting	48BL	RL48	RM48
Double faston, wall mounting	48L	RL48	RM48
For flush mounting			
Double faston (4.8 x 0.8 mm)	ADF2	RL48	RM48
Screw	43IL ⁽¹⁾	RL43	RM43
For mounting on PCB			
	65	RL43	RM43

(1) Insert the clip before fastening the socket on the panel.
For more details, see specifications of mounting accessories.

Mounting tips

The preferred mounting position is on the wall, with the relay positioned horizontally in the reading direction on the nameplate. For correct use of the relays, they should be spaced apart by at least 5 mm in the horizontal direction and 20 mm in the vertical direction. This is to allow correct upward dissipation of the heat generated by the coil. Set these distances according to the socket used. Distances can be reduced depending on the environmental application conditions and on the relay duty cycle. For safe and secure operation, it is advisable to use retaining clips, especially where relays are exposed to shock and vibration. No special maintenance is required. Condensation can form inside the relay when powered up and the outside ambient temperature is cold; this is quite normal and does not affect the operation of the relay. The plastic materials of the relay do not possess hygroscopic properties.

TOK-L • OKRE-L TOK-FP • OKRE-FP CLE SERIE



TOK Series



OKRe Series,
flat head slotted screw
setting control



OKRe Series,
knob setting control

OVERVIEW

- "L": flasher function with symmetrical output pulse, adjustable or fixed
- "FP": one-shot function, adjustable
- Wide range of time settings available
- Solid and rugged construction for heavy or intensive duty
- Considerable long-life
- Patent operating mechanism, designed to ensure high contact pressure (TOK)
- Independent and self-cleaning contacts
- Magnetic arc blow-out standard
- Excellent shock and vibration resistance
- Wide range of sockets
- Retaining clip for secure locking of relay on socket
- Transparent cover, pull-out handle
- Positive mechanical keying for relay and socket

APPLICATIONS



Shipbuilding



Petroleum
industry



Heavy
industry



Power
generation



Power
distribution



Railway
equipment

DESCRIPTION

Logic relays of "FLASHER" or "ONE SHOT" type are available in 5 models, derived from the TOK and OKR series. TOK-L, OKRe-L and CLE models are flasher type relays, whereas TOK-FP and OKRe-FP models are of the one-shot type. Relays of the TOK series provide higher breaking capacity and longer mechanical life expectancy than those of the OKR / CLE series.

Flasher relays: when the component is energized, the coil of the relay is piloted by an electronic circuit, delivering voltage pulses in a continuous symmetrical ON/OFF cycle. Accordingly, the contacts change status cyclically, for as long as the control voltage is applied to the circuit. These relays can be specified with an adjustable or fixed intermittence frequency; in the case of an adjustable frequency, the setting is made by way of a potentiometer having a knob type or flat head slotted screw type control.

One-shot relay: when the component is energized, the coil of the relay is piloted by an electronic circuit, delivering voltage pulses. Accordingly, the contacts change status instantaneously and return to the break conditions after a predetermined interval of time, even with the control voltage applied to the circuit. Relays can be provided with a pulse of adjustable duration or a pulse of fixed duration. In the case of an adjustable pulse, the setting is made by way of a potentiometer having a knob type or a flat head slotted screw type control.

Excellent electrical and mechanical performance levels allow the product to be used in the most demanding of sectors such as, for example, in electricity generating stations, electrical transformer stations, rail transport or in industries using continuous production processes (chemical and petrochemical, rolling mills, cement factories, etc.). In particular, with their notable shock and vibration resistance, they are ideal for use on rolling stock.

Models	Logic Function	Number of contacts	Range of contacts	Output	Setting control		Rolling stock application
					Knob	Flat head slotted screw	
OKRe-L	Flasher	4	5A	50%ON / 50%OFF adjustable up to 1h	•	•	•
TOK-L		4	10A	50%ON / 50%OFF adjustable up to 1h		•	•
CLE		4	5A	50%ON / 50%OFF, fixed 55 – 90 pulse/min	-	-	
OKRe-FP	One-shot	4	5A	Adjustable up to 1h	•	•	•
TOK-FP		4	10A	Adjustable up to 1h		•	•

FOR CONFIGURATION OF PRODUCT CODE, SEE "ORDERING SCHEME" TABLE

Coil data	
Nominal voltages Un (1)	DC : 24-36-48-72-110-125-132-144-220 AC : 24-48-110-125-220-230
Max. consumption at Un (DC/AC)	4 W / 4 VA
Operating range ⁽¹⁾	80...115 % Un DC : 70...125 % Un
Rolling stock version ⁽²⁾	
Type of duty	Continuous

(1) Other values on request.

(2) See "Ordering scheme" table for order code.

Contact data	CLE	OKRe-L	OKRe-FP	TOK-L	TOK-FP
Number and type	4 SPDT, form C				
Current	Nominal ⁽¹⁾	5 A		10 A	
	Maximum peak (1s) ⁽²⁾	10 A		20 A	
	Maximum pulse (10ms) ⁽²⁾	100 A		150 A	
Example of electrical life expectancy ⁽³⁾	0.2 A – 110 Vdc – L/R 0 ms : 10 ⁵ operations - 1800 operations / hour			0.5 A – 110 Vdc – L/R 40 ms : 10 ⁵ - 1800 operations / hour	
Minimum load	Standard contacts	500mW (20V, 20mA)			
	Gold-plated contacts P4GEO ⁽⁴⁾	100mW (10V, 5mA)		200mW (20V, 5mA)	
	Gold-plated contacts P8 ⁽⁴⁾	50mW (5V, 5mA)		-	
Maximum breaking voltage	250 Vdc / 350 Vac			350 Vdc / 440 Vac	
Contact material	AgCu				

(1) Nominal current: on all contacts simultaneously, reduction of 30%.

(2) The max. peak and pulse currents are those currents that can be handled, for a specified time, by the contact. They do not refer to steady or interrupted currents.

(3) For other values, see electrical life expectancy curves.

(4) Specifications of gold-plated contacts on new relay

a) Plating material: **P4 GEO**: gold-nickel alloy (>6µ) **P8**: gold-cobalt alloy (>5µ), knurled contact.

b) When the gold-plated contact is subject to heavy loads, it will be degraded on the surface. In this case, the characteristics of the standard contact should be taken into consideration. This does not impair relay operation.

Insulation	CLE	OKRe-L	OKRe-FP	TOK-L	TOK-FP
Insulation resistance (at 500Vdc) between electrically independent circuits and between these circuits and ground between open contact parts	> 1,000 MΩ > 1,000 MΩ				
Withstand voltage at industrial frequency between electrically independent circuits and between these circuits and ground between open contact parts	2 kV (1 min.) - 2.2kV (1 s) 1 kV (1 min.) - 1.1kV (1 s)			2 kV (1 min.) - 2.2kV (1 s) 2 kV (1 min.) - 2.1kV (1 s)	
Impulse withstand voltage (1.2/50µs - 0.5J) between electrically independent circuits and between these circuits and ground between open contact parts	5 kV 3 kV			5 kV 5 kV	

Mechanical specifications	CLE	OKRe-L	OKRe-FP	TOK-L	TOK-FP
Mechanical life expectancy	20x10 ⁶ operations			100x10 ⁶ operations	
Degree of protection (with relay mounted)	IP40				
Dimensions (mm) ⁽¹⁾	40x45x97			45x45x109	
Weight (g)	~ 220			~ 300	

(1) Excluding output terminals and adjuster knob, if specified.

Environmental specifications	CLE	OKRe-L	OKRe-FP	TOK-L	TOK-FP
Operating temperature					-25 to + 55 °C
Rolling stock version					-25 to + 70 °C
Storage and transport temperature					-25 to + 85 °C
Relative humidity	Standard: 75% RH, Tropicalized: 95% RH				
Resistance to vibrations	5g - 10 to 55 Hz - 1min.			5g - 5 to 60 Hz - 1min.	
Resistance to shock	20g - 11ms			30g - 11ms	
Fire behaviour	V0				

Standards and reference values	
EN 61810-1, EN 61810-2, EN 61810-7 EN 61812-1 EN 60695-2-10 EN 50082-2 EN 60529	Electromechanical elementary relays Timer relays Fire behaviour Electromagnetic compatibility Degree of protection provided by enclosures

Unless otherwise specified, products are designed and manufactured to the requirements of the European and International standards indicated above. In accordance with EN 61810-1, all items of technical data are referred to ambient temperature 23 °C, atmospheric pressure 96kPa and 50% humidity. Tolerance for coil resistance, nominal electrical input and nominal power is $\pm 7\%$.

Railways, rolling stock - Standards	
EN 60077 EN 50155 EN 61373 EN 45545-2 ASTM E162, E662	Electric equipment for rolling stock - General service conditions and general rules Electronic equipment used on rolling stock Shock and vibration tests, Cat 1, Class B Fire behaviour, Cat E10, Requirement R26, V0 Fire behaviour

Configurations - Options	
P2	Tropicalization of coil with epoxy resin for use with 95% RH (@ T 50 °C). This treatment also protects the coil against corrosion which could occur by the combination of humidity with certain chemical agents, such as those found in acid atmospheres (typical of geothermal power stations) or saline atmospheres.
P4GEO	Gold plating of contacts with gold-nickel alloy, thickness $\geq 6\mu$. This treatment ensures long-term capacity of the contact to conduct lower currents in harsh ambient conditions such as acid atmospheres (typical of geothermal power stations) or saline atmospheres.
P5GEO	P4GEO type gold-plating, but applied to contacts, contact terminals and output terminals + P2 coil tropicalization.
P6GEO	Gold-plating of contacts, contact terminals and output terminals + P2 coil tropicalization.
P7	Silver cadmium oxide contacts.
P8	Gold plating of contacts with gold-cobalt alloy, thickness $\geq 5\mu$, knurled fixed contact. This finish allows further improvement of the performance provided by the gold-plated contact, compared to treatment P4GEO.
LED	LED indicator showing presence of power supply, wired in parallel with the coil.
FLYBACK DIODE	Polarized component connected in parallel with the coil (type 1N4007 or BYW56 for rolling stock version) designed to suppress overvoltages generated by the coil when de-energized.
TRANSIL	Non-polarized component connected in parallel with the coil. Behaviour is similar to that of a varistor, with faster operating times.

CLE Ordering scheme

Function	Product code	Application ⁽¹⁾	Configuration A	Configuration B	Type of power supply	Nominal voltage (V) ⁽²⁾	Keying position ⁽³⁾
Flasher	CLE	E: Energy Railway Fixed Equipment	1: Standard	0: Standard 2: P2 4: P4 GEO 5: P5 GEO 6: P6 GEO 7: P7 8: P8	C: Vdc A: Vac 50 Hz H: Vac 60 Hz	024 - 048 - 110 125 - 230	XXX
Example	CLE	E	1	0	H	125	
CLEE10-H125: CLE relay, ENERGY series, standard coil, nominal voltage 125Vac 60Hz							

OKRE-L / OKRE-FP Ordering scheme

Function	Product code	Application ⁽¹⁾	Configuration A	Configuration B	Type of power supply	Nominal voltage (V) ⁽²⁾	Setting control ⁽³⁾	Full scale times ⁽³⁾	Keying position ⁽³⁾
Flasher	OKReL	E: Energy Railway Fixed Equipment	1: Standard 2: Diode // 3: Varistor 4: Led 5: Diode // + Led	0: Standard 2: P2 4: P4 GEO 5: P5 GEO 6: P6 GEO	T: Vdc+ac C: Vdc ⁽⁴⁾	024 - 036 - 048 072 - 110 - 125 132 - 144 - 220 230	M = Knob C = Flat head slotted screw	01S: 1 s 05S: 5 s 10S: 10 s 15S: 15 s 30S: 30 s 01M: 1 min 02M: 2 min 05M: 5 min 10M: 10 min 15M: 15 min 30M: 30 min 60M: 60 min	xxx
One-shot	OKReFP	R: Railway Rolling Stock	6: Varistor + Led 7: Transil 8: Transil + Led	7: P7 8: P8					
Example	OKReL	R	1	2	C	072	M	01S	
OKReLR12-C072-M01S: OKRe-L relay, rolling stock series, P2 coil tropicalization, nominal voltage 72Vdc, full scale 1 second, knob setting control									
Example	OKReFP	E	4	8	T	110	C	05M	
OKReFPE48-C110-C05M: OKRe-FP relay, energy series, nominal voltage 110Vdc/ac, full scale 5 minutes, slotted screw setting control, with led, P8 finish (gold-plated contacts)									

TOK-L / TOK-FP Ordering scheme

Function	Product code	Application ⁽¹⁾	Configuration A	Configuration B	Type of power supply	Nominal voltage (V) ⁽²⁾	Full scale times ⁽³⁾	Keying position ⁽³⁾
Flasher	TOK-L	E: Energy Railway Fixed Equipment	4: Led (fixed range)	0: Standard 2: P2 4: P4 GEO 5: P5 GEO 6: P6 GEO	C: Vdc ⁽⁴⁾ A: Vac 50 Hz H: Vac 60 Hz	024 - 036 - 048 072 - 110 - 125 132 - 144 - 220 230	01S: 1 s 02S: 2 s 04S: 4 s 08S: 8 s 16S: 16 s 32S: 32 s 01M: 1 min 02M: 2 min 04M: 4 min 08M: 8 min 16M: 16 min 32M: 32 min 64M: 64 min	xxx
One-shot	TOK-FP	R: Railway Rolling Stock						
Example	TOK-L	R	4	0	C	072	64M	
TOKLR40-C072-64M: TOK-L relay, railways series, rolling stock, nominal voltage 72Vdc, full scale 64 minutes								
Example	TOK-FP	E	4	2	A	220	04S	
TOKFPE42-A220-04S: TOK-FP relay, energy series, P2 coil tropicalization, nominal voltage 220Vac, full scale 4 seconds								

(1) E = ENERGY: all applications, except for railways rolling stock.

Suitable on energy production, transport and distribution plants, railways fixed equipment, petrochemical and heavy industry.

R = RAILWAYS, ROLLING STOCK: Application on board rolling stock (rail-tram-trolley vehicles). Electrical characteristics according to EN60077.

Available also the product series:

RAILWAYS, FIXED EQUIPMENT: Approved and conforming relays and products to RFI (FS Group) specification no. RFI DPRIM STF IFS TE 143 A

For the list of RFI approved and conforming products, consult dedicated catalogue "RAILWAY SERIES - RFI APPROVED".

STATIONS: ENEL approved material meeting LV15/LV16 specifications.

For the list of ENEL approved and conforming products, consult the dedicated catalogue "STATIONS SERIES - LV15-LV16-LV20".

CLE: also available is the Stations series, with ENEL approved material meeting LV15/LV16 specifications. Consult the dedicated catalogue for more information.

(2) Other values on request.

(3) Optional value. The positive mechanical keying is applied according to the manufacturer's model.

(4) Rolling Stock version, Vdc only available.

Wiring diagram

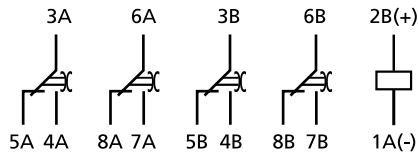

CLE, OKRE-L

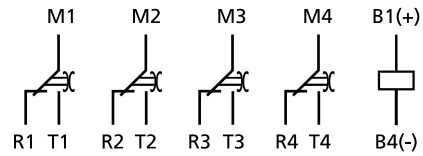

TOK-L

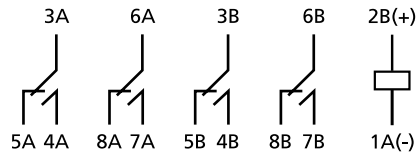

OKRE-FP

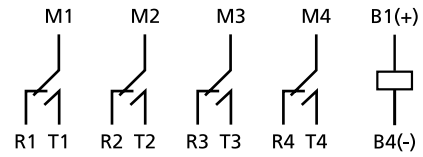

TOK-FP

Functional diagram

CLE, OKRE-L, TOK-L

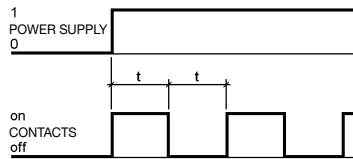

OKRE-FP, TOK-FP

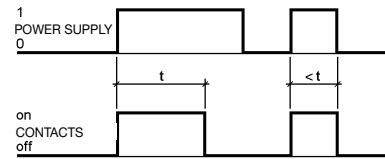

Time delay

Switching time setting

	OKRE-L OKRE-FP	TOK-L TOK-FP	CLE
Time setting	By way of potentiometer, with knob or flat head slotted screw control	By way of potentiometer, with flat head slotted screw control	No time setting 55 ... 90 pulse/min symmetrical
Full scale times available	1-5-10-15-30 seconds, 1-2-5-10-30-60 minutes	1-2-4-8-16-32 seconds, 1-2-4-8-16-32-64 minutes	
Time setting range	10 ÷ 100 % of full scale	10 ÷ 100 % of full scale	
Accuracy, setting (0,8...1,1 Un, t=20°C)	± 10% of time delay	± 5% of time delay	
Accuracy, repeatability	DC: 0.5% / AC: ± 0.5% + 20ms		
Reset	< 100ms, in time-delay phase < 1s		

Dimensions

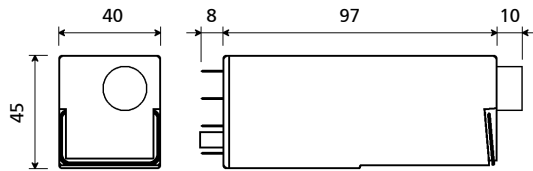

OKRE-L / OKRE-FP with knob setting control

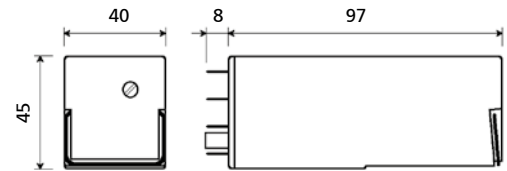

OKRE-L / OKRE-FP with flat head slotted screw setting control

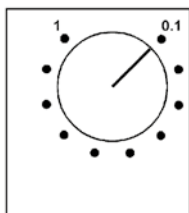

Knob setting control

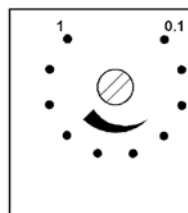

Flat head slotted screw setting control

The scale shown on the relay (0.1-1) is approximate

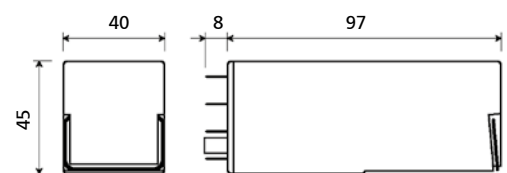

CLE

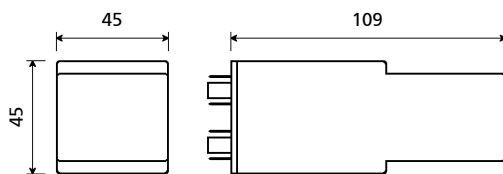

TOK-L / TOK-FP

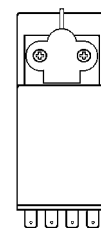

TOK-L / TOK-FP finish for ROLLING STOCK version

CLE OKRE-L OKRE-FP

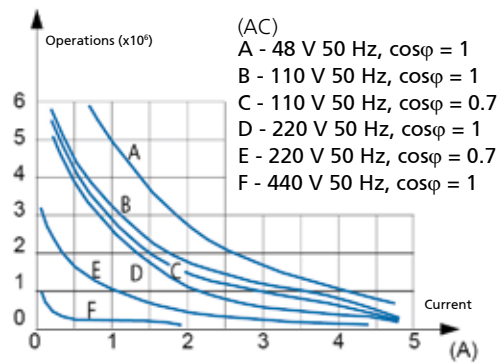
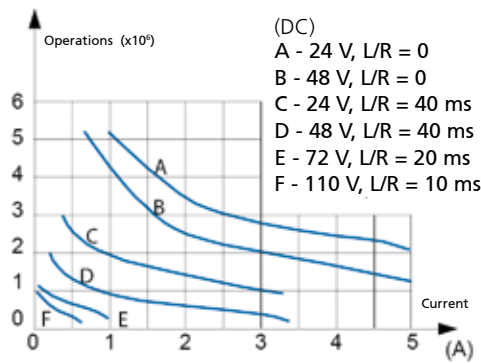

Some examples of electrical life expectancy
 48Vdc - 5 A - L/R = 10 ms : 5 x 10⁵ operations
 80Vdc - 5 A - Resistive: 5 x 10⁵ operations
 110Vdc - 0.5 A - L/R = 10 ms : 5 x 10⁵ operations

220Vdc - 0.2 A - L/R = 10 ms : 10⁵ operations
 110Vac - 5 A - Cosφ = 0.7 : 5 x 10⁵ operations
 220Vac - 3 A - Cosφ = 0.7 : 5 x 10⁵ operations
 440Vac - 0.2 A - Resistive: 5 x 10⁵ operations

TOK-L TOK-FP

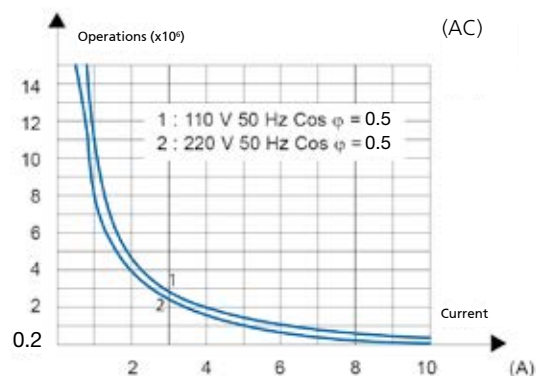
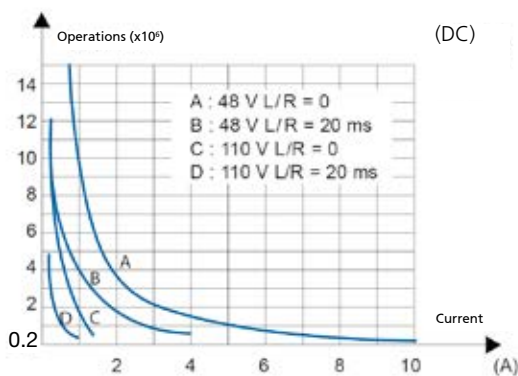

Other examples of electrical life expectancy available on the technical data sheet of the OK series relay (OKSFC model)

Sockets and retaining clips		CLE OKRe-L OKRe-FP	TOK-L TOK-FP
Number of terminals (standard dimensions 5x0.8mm)		16	
For wall or rail mounting		Retaining clip ⁽²⁾	
Spring clamp, wall or DIN H35 rail mounting		RC48	RL48
Screw, wall or DIN H35 rail mounting		RC48	RL48
Screw, wall mounting		RC48	RL48
Double faston, wall mounting		RC48	RL48
For flush mounting			
Double faston (4.8 x 0.8 mm)		RC48	RL48
Screw		RC43	RL43
For mounting on PCB		65	RC43

(1) Insert the clip before fastening the socket on the panel.
 (2) Assume two clips for use on rolling stock.
 For more details, see specifications of mounting accessories.

Mounting tips

The preferred mounting position is on the wall, with the relay positioned horizontally in the reading direction on the nameplate. For correct use of the relays, they should be spaced apart by at least 5 mm in the horizontal direction and 20 mm in the vertical direction. This is to allow correct upward dissipation of the heat generated by the coil. Set these distances according to the socket used. Distances can be reduced depending on the environmental application conditions and on the relay duty cycle. For safe and secure operation, it is advisable to use retaining clips. No special maintenance is required. Condensation can form inside the relay when powered up and the outside ambient temperature is cold; this is quite normal and does not affect the operation of the relay. The plastic materials of the relay do not possess hygroscopic properties.

Notes

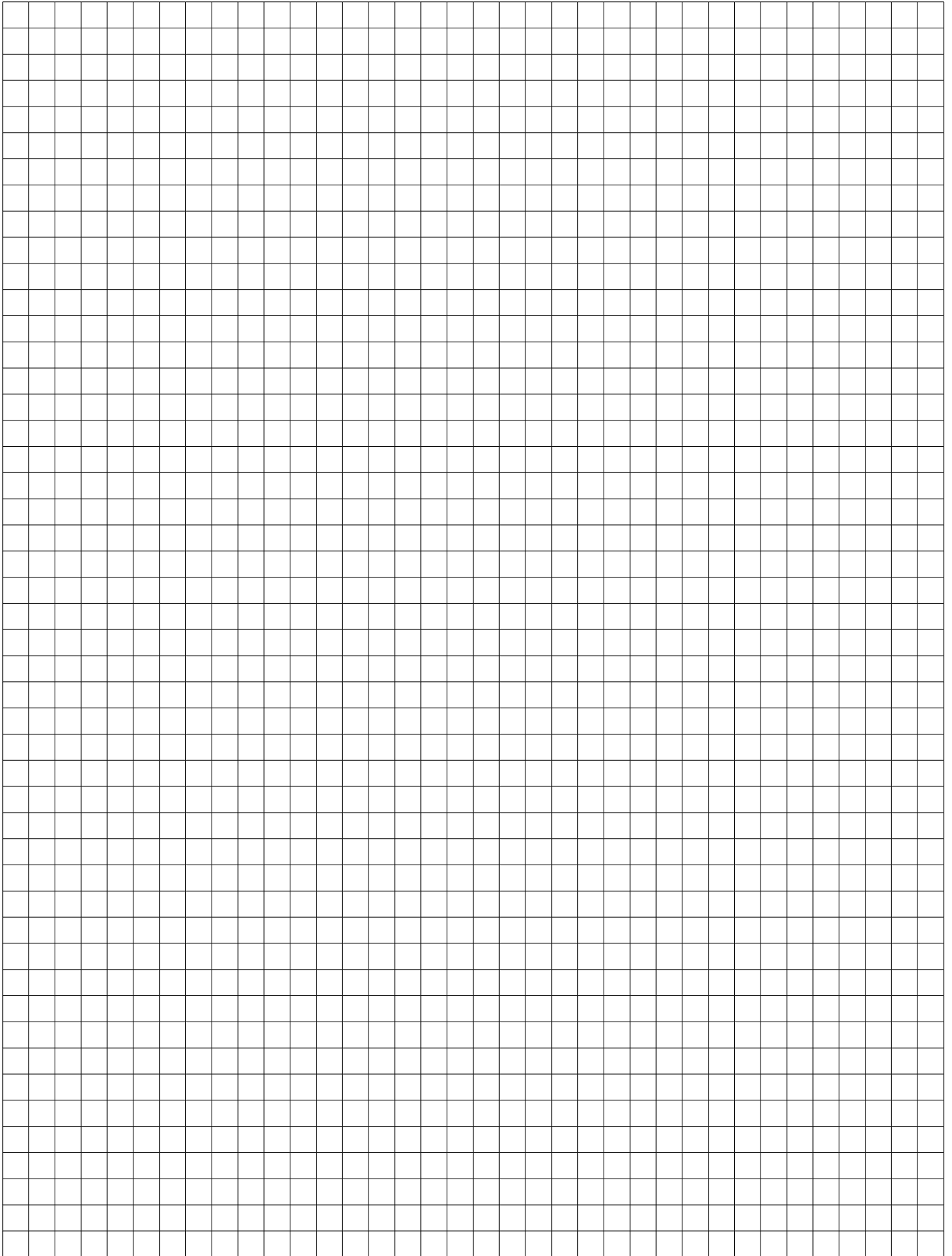





MTI LINE

Instantaneous monostable relay

2-4 contacts

2.01

RCM AND RDM SERIES

OVERVIEW

- Compact plug-in instantaneous monostable relays
- High performance, compact dimensions
- Self-cleaning knurled contacts
- Magnetic arc blow-out for higher breaking capacity
- Fitted with mechanical optical contact status indicator as standard
- Relay coupled automatically to socket, with no need for a retaining clip
- Operation using d.c. or a.c. power supply (directly, without rectifiers or diodes)
- Wide variety of configurations and customizations
- Also available in current-monitoring version
- Also available in PCB-mount version
- Transparent cover, pull-out handle
- Label holder in cover for customer's use
- Positive mechanical keying for relay and socket



RCME



RDME

APPLICATIONS



Shipbuilding



Petroleum industry



Heavy industry



Power generation



Power distribution



Railway equipment

DESCRIPTION

The C and D series are made up of 2 basic models with 2 and 4 change-over contacts, respectively, having similar electrical specifications.

With their compact dimensions and optimum performance, these relays are suitable for the widest imaginable range of applications, from controlling devices such as HV/MV breakers to the supervision of low power logic circuits. The contacts used are of a type designed to give good levels of performance both with high and strongly inductive d.c. loads, and with particularly low loads such as interface signals; inclusion of the magnetic arc blow-out function (optional) helps to achieve a considerable increase in breaking capacity. Knurled contacts ensure not only better self-cleaning characteristics, but also lower ohmic resistance thanks to multiple points of electrical connection, thereby extending the electrical life expectancy of the component. The construction of the relays and their simplified mechanical design combine to ensure these products offer high reliability in operation, as proven by their use for over 40 years in electrical energy transport and distribution systems, and fixed equipment used in the railway sector. Benefiting from careful selection of materials, coupled with the technical and professional skills of human resources involved in design and production, this family of relays has found favour with many important and high profile customers.

Like all AMRA relays, models of the C and D series are assembled as part of a controlled manufacturing process in which every step of production is verified by the next step in succession. In effect, each relay is calibrated and tested individually, by hand, in such a way as to guarantee top reliability.

Versatility in manufacture allows the production of relays with any voltage in the range 12 to 220VDC/440VAC, and with a variety of operating ranges adaptable to different application requirements. Typical sectors of use are among the most demanding, such as, for example, electricity generating stations, electrical transformer stations, fixed equipment for railways, or industries using continuous production processes (chemical and petrochemical, rolling mills, cement factories, etc.). To simplify the operations of installing the relay on the various dedicated sockets, the sockets themselves are equipped with special catches allowing the installer to dispense with retaining clips, although these remain available as accessories.

Models	Number of contacts	Magnetic arc blow-out	PCB-mount
RCMEx2 - RCMFx2	2		
RCMMx2	2		•
RCMEx6 - RCMFx6	2	•	
RCMMx6	2	•	•
RDMEx2 - RDMFx2	4		
RDMMx2	4		•
RDMEx6 - RDMFx6	4	•	
RDMMx6	4	•	•

FOR CONFIGURATION OF PRODUCT CODE, SEE "ORDERING SCHEME" TABLE

Coil data	RCM	RDM
Nominal voltages Un	DC: 12-24-48-110-125-132-144-220 ⁽¹⁾ - AC: 12-24-48-110-125-220-230-380-440 ⁽¹⁻²⁾	
Consumption at Un (DC/AC)	2W ⁽³⁾ / 3.2VA ⁽⁴⁾ - 4VA ⁽⁵⁾	2.5W / 5VA ⁽⁴⁾ - 7.5VA ⁽⁵⁾
Operating range	DC: 80...120% Un - AC: 85...110% Un	
Type of duty	Continuous	
Drop-out voltage ⁽⁶⁾	DC: > 5% Un - AC: > 15% Un	

(1) Other values on request.

(2) Maximum value, a.c. = 380V 50Hz - 440V 60Hz.

(3) 2.3W for 220Vdc.

(4) In operation.

(5) On pick-up.

(6) Limit value for supply voltage, expressed as % of the nominal value, beneath which the relay is certain to be de-energized.

Contact data	RCM	RDM		
Number and type	2 SPDT, form C	4 SPDT, form C		
Current	10A			
Nominal ⁽¹⁾	13A for 1min - 20A for 1s			
Maximum peak ⁽²⁾	100A for 10ms			
Maximum pulse ⁽²⁾				
Example of electrical life expectancy ⁽³⁾	RCM.x2 - RDM.x2 : 0.2A - 110Vdc - L/R 40ms - 500,000 operations – 1,800 operations/hour RCM.x6 - RDM.x6 : 0.5A - 110Vdc - L/R 40ms - 150,000 operations – 1,800 operations/hour			
Minimum load	200mW (10V, 10mA)			
Standard contacts	50mW (5V, 5mA)			
Gold-plated contact				
Maximum breaking voltage	250 Vdc / 300 Vac			
Contact material	AgCdO (moving contacts) - AgNi (fixed contacts)			
	RCM.12-16-42-46	RCM.32-36-62-66	RDM.12-16-42-46	RDM.32-36-62-66
Operating time at Un (ms) ⁽⁴⁾	DC - AC	DC	DC - AC	DC
Pick-up (NC contact opening)	≤ 10 - ≤ 10	≤ 10	≤ 14 - ≤ 10	≤ 14
Pick-up (NO contact closing)	≤ 19 - ≤ 18	≤ 19	≤ 23 - ≤ 17	≤ 23
Drop-out (NO contact opening)	≤ 4 - ≤ 8	≤ 11	≤ 5 - ≤ 8	≤ 32
Drop-out (NC contact closing)	≤ 16 - ≤ 19	≤ 28	≤ 14 - ≤ 19	≤ 45

(1) On all contacts simultaneously, reduction of 30%.

(2) Maximum peak and pulse currents are those currents that can be handled, for a specified time, by the contact. They do not refer to steady or interrupted currents.

(3) For other examples, see electrical life expectancy curves.

(4) Unless specified otherwise, operating times are understood as comprising stabilization of the contact (inclusive of bounces).

Insulation	
Insulation resistance (at 500Vdc)	
between electrically independent circuits and between these circuits and ground	> 1000 MΩ
between open contact parts	> 1000 MΩ
Withstand voltage at industrial frequency	
between electrically independent circuits and between these circuits and ground	2 kV (1 min) - 2.2 kV (1 s)
between open contact parts	2 kV (1 min) - 2.2 kV (1 s)
between adjacent contacts	2 kV (1 min) - 2.2 kV (1 s)
Impulse withstand voltage (1.2/50μs - 0.5J)	
between electrically independent circuits and between these circuits and ground	5 kV
between open contact parts	3 kV

Mechanical specifications

Mechanical life expectancy	20x10 ⁶ operations	
Maximum switching rate	Mechanical	3,600 operations/hour
Degree of protection (with relay mounted)	IP40	
	RCM	RDM
Dimensions (mm)	40x20x50 ⁽¹⁾	40x40x50 ⁽¹⁾
Weight (g)	60	115

1. Output terminals excluded.

Environmental specifications

Operating temperature	-25 to +55 °C
Storage and shipping temperature	-25 to +70°C
Relative humidity	Standard: 75% RH - Tropicalized: 95% RH
Fire behaviour	V0

Standards and reference values

EN 61810-1, EN 61810-2, EN 61810-7 EN 60695-2-10 EN 50082-2 EN 60529	Electromechanical elementary relays Fire behaviour Electromagnetic compatibility Degree of protection provided by enclosures
---	---

Unless otherwise specified, products are designed and manufactured according to the requirements of the European and International standards indicated above. In accordance with EN 61810-1, all items of technical data are referred to ambient temperature 23 °C, atmospheric pressure 96kPa and 50% humidity. Tolerance for coil resistance, nominal electrical input and nominal power is ±7%.

Configurations - Options

TROPICALIZATION	Surface treatment of the coil with protective coating for use with RH 95%.
GOLD PLATING	Surface treatment of contacts, blades and output terminals with gold-cobalt alloy, thickness ≥2μ. This treatment ensures long-term capacity of the contact to conduct lower currents.
LED	LED indicator showing presence of power supply, wired in parallel with the coil, as alternative to mechanical optical indicator.
FLYBACK DIODE	Component connected in parallel with the coil (type 1N4007) designed to suppress overvoltages generated by the coil when de-energized.

Ordering scheme

Product code	Application ⁽¹⁾	Configuration A	Configuration B	Type of power supply	Nominal voltage (V) ⁽²⁾	Finish ⁽³⁾	Keying position code ⁽⁴⁾
RCM (2 contacts)	E: Energy F: Railway Fixed Equipment	1: Standard 3: Diode // 4: Gold plating 5: Led 6: Gold plating + Diode //	2: Standard 6: With magnetic arc blow-out	C: Vdc A: Vac 50 Hz H: Vac 60 Hz	012 - 024 - 048 110 - 125 - 132 144 - 220 - 230 380 - 440	T: Tropicalized coil	xx
RDM (4 contacts)	M: For PCB	7: Diode // + Led					

Example	RCM	E	4	2	A	048	T	
	RCME42-A048/T = ENERGY series relay with 2 SPDT gold-plated contacts, 48V 50Hz tropicalized coil							
	RDM	F	1	6	C	110		DH
	RDMF16-C110-DH = RAILWAY series relay, fixed equipment, with 4 SPDT gold-plated contacts, magnetic arc blow-out, 110Vdc coil and keying position DH							

(1) ENERGY: all applications except for railway.

RAILWAYS, FIXED EQUIPMENT: application on fixed power systems and electrical railway traction.

For list of RFI compliant and type-approved products, consult dedicated catalogue "RAILWAY SERIES – RFI APPROVED".

M: PCB-mount models. Specifications as per "Energy" application but with output terminals suitable for soldering to PCB.

Also available is the STATIONS series, with ENEL approved material meeting LV15/LV16 specifications. For list of ENEL compliant and type-approved products, consult dedicated catalogue "STATIONS SERIES – LV15-LV16-LV20"

(2) Other values on request. Voltages 380V and 440V available as Vac only.

(3) Optional value.

(4) Optional value. The positive mechanical keying is applied according to the manufacturer's model.

Wiring diagram

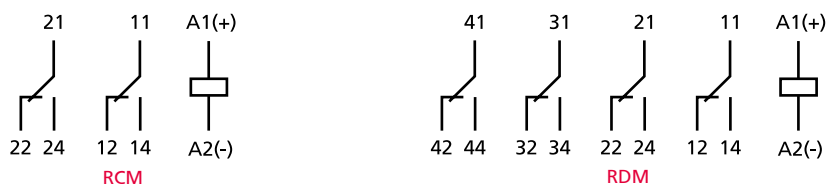

Dimensions

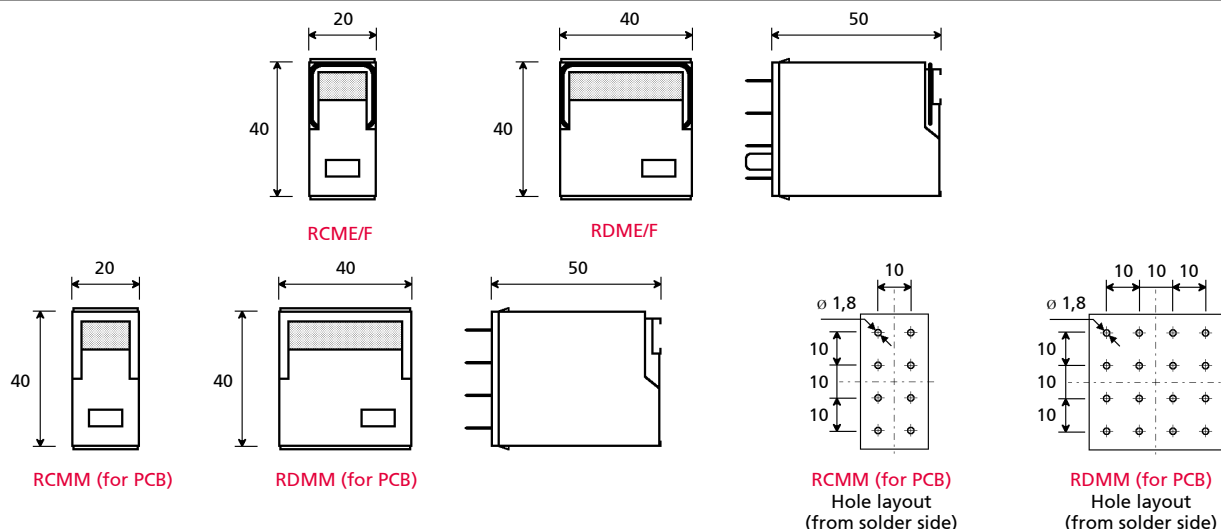

Electrical life expectancy

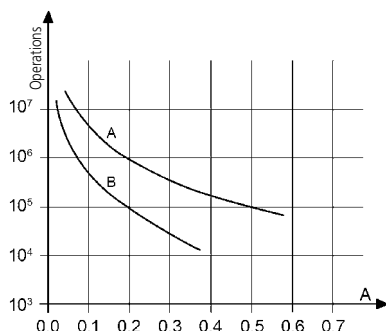

Contact loading: 110Vdc, L/R 40 ms
 Curve A: RCM.x6, RDM.x6
 Curve B: RCM.x2, RDM.x2

RCM.12, RDM.12			
U	I (A)	L/R (ms)	Operations
110Vdc	0.2	40	500,000
220Vdc	0.2	10	80,000
U	I (A)	cosφ	Operations
110Vac	1	1	1,200,000
110Vac	1	0.5	1,000,000
110Vac	5	1	500,000
110Vac	5	0.5	300,000
220Vac	0.5	1	1,200,000
220Vac	1	0.5	500,000
220Vac	5	1	400,000
220Vac	5	0.5	300,000

Switching frequency: 1,200 operations/hour
 (*) = 600 operations/hour

RCM.16, RDM.16			
U	I (A)	L/R (ms)	Operations
110Vdc	0.2	40	1,000,000
110Vdc	0.5	40	150,000
110Vdc	0.6	10	300,000
110Vdc	1	10	100,000 (*)
220Vdc	0.2	10	100,000
U	I (A)	cosφ	Operations
110Vac	1	1	2,000,000
110Vac	1	0.5	1,500,000
110Vac	5	1	950,000
110Vac	5	0.5	500,000
220Vac	0.5	1	2,000,000
220Vac	1	0.5	800,000
220Vac	5	1	600,000
220Vac	5	0.5	500,000

Sockets and retaining clips		RCME - RCMF	RDME - RDMF	Retaining clip
Type of installation	Type of outputs			
Wall or DIN H35 rail mounting	Screw	PAVC081	PAVD161	VM1821
Flush mounting	Double faston (4.8 x 0.8 mm)	PRDC081	-	-
	Screw	PRVC081	PRVD161	-
PCB-mount	Solder	PRCC081	PRCD161	-

Mounting tips

The preferred mounting position is on the wall, with the relay positioned horizontally in the reading direction on the nameplate. For correct use of the relays, they should be spaced apart by at least 5 mm in the horizontal direction and 20 mm in the vertical direction. This is to allow correct upward dissipation of the heat generated by the coil. Set these distances according to the socket used. Distances can be reduced depending on the environmental application conditions and on the relay duty cycle. No special maintenance is required. Condensation can form inside the relay when powered up and the outside ambient temperature is cold; this is quite normal and does not affect the operation of the relay. The plastic materials of the relay do not possess hygroscopic properties.

Monostable instantaneous relay 4 contacts

2.02

RQM SERIES



RGME

OVERVIEW

- Plug-in monostable instantaneous relay
- Solid and rugged construction for heavy or intensive duty
- Very high electrical life expectancy and exceptional endurance
- Magnetic arc blow-out for higher breaking capacity
- Self-cleaning knurled contacts
- Lever for manual operation (optional)
- Fitted with mechanical optical contact status indicator as standard
- Operation using d.c. or a.c. power supply (directly, without rectifiers or diodes)
- Wide variety of configurations and customizations
- Also available in current-monitoring version
- Retaining clip for secure locking of relay on socket
- Transparent cover, pull-out handle
- Label holder in cover for customer's use
- Positive mechanical keying for relay and socket

APPLICATIONS



Shipbuilding



Petroleum industry



Heavy industry



Power generation



Power distribution



Railway equipment

DESCRIPTION

Relays of the RGM series are highly reliable products providing top performance, suitable for applications in particularly harsh and unsettled environments, such as high voltage electricity distribution stations and medium voltage substations. The mechanical design of the relay is such as to allow the development of numerous custom solutions, in the event that the standard models do not fully respond to the required performance parameters. Thanks to its exceptional breaking capacity, the relay is suitable for controlling heavy duty loads with intensive switching frequency, where safety and continuity of operation are all-important. A product of proven reliability, as demonstrated by its use for over 40 years in electrical energy transport and distribution systems, and fixed equipment used in the railway sector. Benefiting also from careful selection of materials, coupled with the technical and professional skills of human resources involved in design and production, this family of relays has found favour with many important and high profile customers.

Versatility in manufacture allows the production of relays with any voltage in the range 12 to 250VDC/440VAC, and with a variety of operating ranges adaptable to different application requirements.

The contacts used are of a type designed to give notable levels of performance both with high and strongly inductive d.c. loads, and with particularly low loads; inclusion of the magnetic arc blow-out function (optional) helps to achieve a considerable increase in breaking capacity. Knurled contacts ensure not only better self-cleaning characteristics, but also lower ohmic resistance thanks to multiple points of electrical connection, thereby extending the electrical life expectancy of the component.

All models offer the facility of manual operation, so that tests can be performed even in the absence of electrical power.

Like all AMRA relays, models of the G series are assembled as part of a controlled manufacturing process in which every step of production is verified by the next step in succession. In effect, each relay is calibrated and tested individually, by hand, in such a way as to guarantee top reliability.

Models	Number of contacts	Magnetic arc blow-out
RGM.x3	4	
RGM.x4	4 + 1NO	
RGM.x5	4 + 1NC	
RGM.x7	4	•
RGM.x8	4, long travel	•

FOR CONFIGURATION OF PRODUCT CODE, SEE "ORDERING SCHEME" TABLE

Coil data	RGMExy - RGMFxy	RGMEx8
Nominal voltages Un	DC: 12-24-48-110-125-132-144-220 ⁽¹⁾ - AC : 12-24-48-110-125-220-230-380-440 ⁽¹⁻²⁾	
Consumption at Un (DC/AC)	3W / 6.5VA ⁽³⁾ - 11.5VA ⁽⁴⁾	3.5W / 8VA ⁽³⁾ - 13VA ⁽⁴⁾
Operating range	DC: 80...120% Un - AC: 85...110% Un	
Type of duty	Continuous	
Drop-out voltage ⁽⁵⁾	DC : > 5% Un - AC : > 15% Un	

(1) Other values on request.

(2) 380V 50Hz, 440V 60Hz.

(3) In operation.

(4) On pick-up.

(5) Limit value for supply voltage, expressed as % of the nominal value, beneath which the relay is certain to be de-energized.

Contact data

Number and type	4 SPDT, form C								
Current	Nominal ⁽¹⁾	12A ⁽²⁾							
	Maximum peak ⁽³⁾	20A for 1min - 40A for 1s							
	Maximum pulse ⁽³⁾	150A for 10ms							
Example of electrical life expectancy ⁽⁴⁾	RGM.x3-x4-x5 : 0.5A - 110Vdc - L/R 40ms - 10 ⁵ operations - 1800 operations/hour RGM.x4-x5 (NC or NO auxiliary contact) : 0.2A - 110Vdc - L/R 40ms - 10 ⁵ operations - 1800 operations/hour RGM.x7 : 1A - 110Vdc - L/R 40ms - 10 ⁵ operations - 1800 operations/hour RGM.x8 : 1A - 125 Vdc - L/R 40ms - 10 ⁶ operations - 600 operations/hour								
Minimum load	Standard contacts	200mW (10V, 10mA)							
	Gold-plated contacts	50mW (5V, 5mA)							
Maximum breaking voltage	350 VDC / 440 VAC								
Contact material	AgCdO								
Operating time at Un (ms) ⁽⁵⁾		RGM.13-17-43-47	RGM. 33-37-63-67	RGM.18	RGM.38	RGM.14-44	RGM. 34-64	RGM. 15-45	RGM. 35-65
		DC - AC	DC	DC - AC	DC	DC - AC	DC	DC - AC	DC
	Pick-up (NC contact opening)	≤ 20 - ≤ 11	≤ 20	≤ 20 - ≤11	≤ 20	≤ 16 - ≤ 11	≤ 16	≤ 16 - ≤11	≤16
	Pick-up (NO contact closing)	≤ 35 - ≤ 30	≤ 35	≤ 40 - ≤35	≤ 40	≤ 35 - ≤ 30	≤ 35	≤ 35 - ≤30	≤35
	Drop-out (NO contact opening)	≤ 10 - ≤ 20	≤ 47	≤ 10 - ≤20	≤ 47	≤ 10 - ≤ 25	≤ 47	≤ 10 - ≤25	≤ 47
	Drop-out (NC contact closing)	≤ 53 - ≤ 65	≤ 85	≤ 60 - ≤70	≤ 95	≤ 70 - ≤ 75	≤ 100	≤ 70 - ≤75	≤ 100
	Pick-up (NC auxiliary contact opening)	-	-	-	-	-	-	≤ 16 - ≤12	≤ 20
	Pick-up (NO auxiliary contact closing)	-	-	-	-	≤ 33 - ≤ 25	≤ 33	-	-
	Drop-out (NO auxiliary contact opening)	-	-	-	-	≤ 30 - ≤ 45	≤ 46	-	-
Drop-out (NC auxiliary contact opening)	-	-	-	-	-	-	≤ 70 - ≤75	≤ 95	

(1) On all contacts simultaneously, reduction of 30%.

(2) Models RGM.x4 / RGM.x5 only: 5° NO or NC contact: nominal current 5 A.

(3) Maximum peak and pulse currents are those currents that can be handled, for a specified time, by the contact. They do not refer to steady or interrupted currents.

(4) For other examples, see electrical life expectancy curves.

(5) Unless specified otherwise, the operating time signifies until stabilization of the contact (including bounces).

Insulation

Insulation resistance (at 500Vdc) between electrically independent circuits and between these circuits and ground between open contact parts	> 10,000 MΩ > 10,000 MΩ
Withstand voltage at industrial frequency between electrically independent circuits and between these circuits and ground between open contact parts between adjacent contacts	2 kV (1 min.) - 2.2kV (1 s) 2 kV (1 min.) - 2.2kV (1 s) ⁽¹⁾ 2 kV (1 min.) - 2.2kV (1 s)
Impulse withstand voltage (1.2/50μs - 0.5J) between electrically independent circuits and between these circuits and ground between open contact parts	5 kV ⁽²⁾ 5 kV ⁽²⁾

For auxiliary contacts (NO - NC) of models RGM.x4 and RGM.x5:

(1) 1kV.

(2) 2kV.

Mechanical specifications

Mechanical life expectancy	20x10 ⁶ operations
Maximum switching rate	3600 operations/hour
Degree of protection	IP40
Dimensions (mm)	45x50x86 ⁽¹⁾
Weight (g)	270

(1) Output terminals excluded

Environmental specifications

Operating temperature	-25 to +55 °C
Storage and shipping temperature	-25 to +70°C
Relative humidity	Standard: 75% RH - Tropicalized: 95% RH
Fire behaviour	V0

Standards and reference values

EN 61810-1, EN 61810-2, EN 61810-7 EN 60695-2-10 EN 50082-2 EN 60529	Electromechanical elementary relays Fire behaviour Electromagnetic compatibility Degree of protection provided by enclosures
---	---

Unless otherwise specified, products are designed and manufactured according to the requirements of the European and International standards indicated above.

In accordance with EN 61810-1, all items of technical data are referred to ambient temperature 23 °C, atmospheric pressure 96kPa and 50% humidity.

Tolerance for coil resistance, nominal electrical input and nominal power is ±7%.

Configurations - Options

TROPICALIZATION	Surface treatment of coil with protective coating for use in conditions of RH 95%.
GOLD PLATING	Surface treatment of contacts, blades and output terminals with gold-cobalt alloy, thickness ≥2μ. This treatment ensures long-term capacity of the contact to conduct lower currents.
LED	LED indicator showing presence of power supply, wired in parallel with the coil, as alternative to mechanical optical indicator.
FLYBACK DIODE	Component connected in parallel with the coil (type 1N4007) designed to suppress overvoltages generated by the coil when de-energized.
LEVER FOR MANUAL OPERATION	Allows manual operation of the relay, with the cover closed, using a screwdriver. If the lever is fitted, there will be no luminous optical indicator.

Ordering scheme

Product code	Application ⁽¹⁾	Configuration A	Configuration B	Type of power supply	Nominal voltage (V) ⁽²⁾	Finish ⁽³⁾	Keying position code ⁽⁴⁾
RGM	E: Energy F: Railway Fixed Equipment	1: Standard 3: Diode // 4: Gold plating 5: Led 6: Gold plating + Diode // 7: Diode // + Led	3: 4 SPDT contacts 4: 4 SPDT contacts + 1 NO auxiliary contact 5: 4 SPDT contacts + 1 NC auxiliary contact 7: 4 SPDT contacts with magnetic arc blow-out 8: 4 SPDT contracts, long travel with magnetic arc blow-out	C: Vdc A: Vac 50 Hz H: Vac 60 Hz	012 - 024 - 048 110 - 125 - 132 144 - 220 - 230 380 - 440	T: Tropicalized coil M: Manual operation	xxx

Example	RGM	E	3	7	C	048	TM	
	RGME37-C048/TM = ENERGY series relay with flyback diode, magnetic arc blow-out, 48Vdc tropicalized coil and manual operating lever.							
	RGM	F	1	3	A	110		OOG
	RGMF17-A110-OOG = RAILWAY series relay, fixed equipment, with 110V 50Hz coil and keying position OOG.							

(1) ENERGY: all applications except for railway.

RAILWAYS, FIXED EQUIPMENT: application on fixed power systems and electrical railway traction. For list of RFI compliant and type-approved products, consult dedicated catalogue "RAILWAY SERIES - RFI APPROVED".

Also available is the STATIONS series, with ENEL approved material meeting LV15/LV16 specifications. For list of ENEL compliant and type-approved products, consult dedicated catalogue "STATIONS SERIES - LV15-LV16-LV20"

(2) Other values on request. Voltages 380V and 440V available as Vac only.

(3) Optional value. Multiple selection possible (e.g. TM).

(4) Optional value. Positive mechanical keying is applied according to the manufacturer's model.

(5) With manual operation, no optical indicator.

Wiring diagram

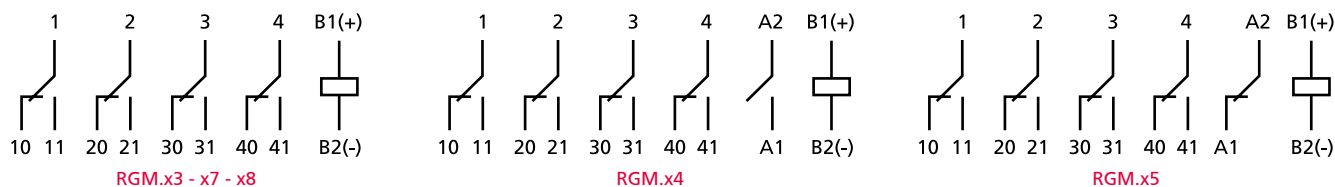

Dimensions

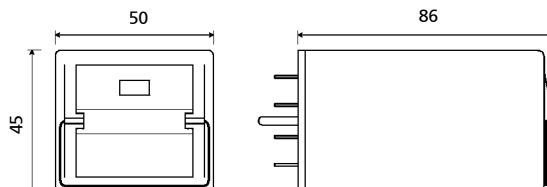

Electrical life expectancy

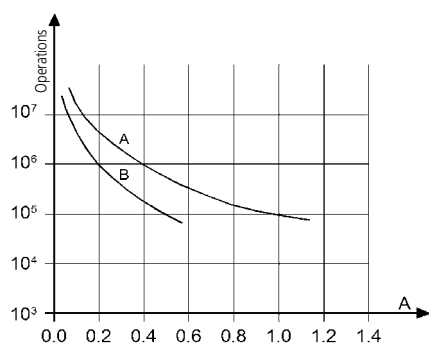

Contact loading: 110Vdc, L/R 40 ms
 Curve A: RGM.x7
 Curve B: RGM.x3-4-5 (NO/NC contact excluded)

RGM.x3 - RGM.x4 - RGM.x5			
U	I (A)	L/R (ms)	Operations
110Vdc	0.5	40	100,000
110Vdc	0.6	10	300,000
120Vdc	0.7	40	50,000
125Vdc	1.2	0	1,000,000
220Vdc	0.1	40	100,000
220Vdc	0.25	10	100,000
U	I (A)	cosφ	Operations
110Vac	1	1	2,000,000
110Vac	1	0.5	1,500,000
110Vac	5	1	1,000,000
110Vac	5	0.5	500,000
220Vac	0.5	1	2,000,000
220Vac	1	0.5	600,000
220Vac	5	1	650,000
220Vac	5	0.5	600,000

Switching frequency: 1,200 operations/hour

RGM.x7			
U	I (A)	L/R (ms)	Operations
24Vdc	1	0	7,000,000
24Vdc	1	40	3,000,000
24Vdc	2	40	2,000,000
24Vdc	5	0	3,000,000
24Vdc	5	40	200,000
24Vdc	9	0	800,000
U	I (A)	cosφ	Operations
48Vdc	5	20	200,000
110Vdc	0.4	40	1,000,000
110Vdc	1	40	100,000
110Vdc	10	0	100,000
U	I (A)	cosφ	Operations
220Vac	5	0.5	100,000
220Vac	10	1	100,000
230Vac	1	0.7	2,500,000
230Vac	3	0.7	1,200,000

RGM.x8			
U	I (A)	L/R (ms)	Operations
125Vdc	1	40	1,000,000
125Vdc	5	40	5,000

Sockets and retaining clips

Type of installation	Type of outputs	Model	Retaining clip
Wall or DIN rail mounting	Screw	PAVG161	VM1221
Flush mounting	Double faston (4.8 x 0.8 mm)	PRDG161	
	Screw	PRVG161	

Mounting tips

The preferred mounting position is on the wall, with the relay positioned horizontally in the reading direction on the nameplate.
 For correct use of the relays, they should be spaced apart by at least 5 mm in the horizontal direction and 20 mm in the vertical direction. This is to allow correct upward dissipation of the heat generated by the coil. Set these distances according to the socket used. Distances can be reduced depending on the environmental application conditions and on the relay duty cycle.
 For safe and secure operation, it is advisable to use retaining clips.
 No special maintenance is required.
 Condensation can form inside the relay when powered up and the outside ambient temperature is cold; this is quite normal and does not affect the operation of the relay. The plastic materials of the relay do not possess hygroscopic properties.

Instantaneous relay, weld-no-transfer 4 contacts

2.03



RQC SERIES WITH FORCIBLY GUIDED CONTACTS

OVERVIEW

- Forcibly guided (mechanically linked) contacts, relay compliant with **EN 61810-3, type A**
- Weld-no-transfer technology
- Plug-in monostable instantaneous relay
- Suitable for safety applications
- Solid and rugged construction for heavy or intensive duty
- Self-cleaning knurled contacts
- Very high electrical life expectancy and exceptional endurance
- Magnetic arc blow-out for higher breaking capacity
- Wide range of option: LED indicating power on, FLYBACK DIODE i.e.
- Retaining clip for secure locking of relay on socket
- Transparent cover, pull-out handle

APPLICATIONS



Shipbuilding



Petroleum industry



Heavy industry



Power generation



Power distribution



Railway equipment



Rolling stock

DESCRIPTION

Relays of the GG line are highly reliable products featuring high performance, suitable for applications in very harsh and disturbed environments. They are provided with forcibly guided (mechanically linked) contacts. The component conforms to the **EN 61810-3** requirements, **type A** relay (all contacts are mechanically linked). Forcibly guided contacts are also known as weld-no-transfer contacts. A typical application is the check reading of a contact for determining, with absolute certainty, the state of the other contacts in self-monitoring control systems.

Thanks to the exceptional breaking capacity, the relay is suitable for controlling heavy duty loads with intensive switching frequency where safety and electrical continuity is an all-important factor.

The versatility in manufacture allows producing relays with any voltage in the range 12 to 230VDC and with a great number of operating ranges adaptable to the various application requirements.

The types of contacts allow obtaining remarkable performance levels both for high, very inductive loads or very low loads; the optional presence of the magnetic arc blow-out contributes considerably to the breaking capacity. The knurled contacts ensure better self-cleaning characteristics and lower ohmic resistance thanks to the various points of electrical connection, thereby improving the electrical life of the component.

In relays with forcibly guided (mechanically linked) or weld-no-transfer contacts, special design and constructional measures are used to ensure that make (normally-open) contacts can not assume the same state as break (normally-closed) contacts.

- If, when powering up a relay, a NC contact fails to open, the remaining NO contacts must not close, maintaining a contact gap ≥ 0.5 mm

- When the relay is de-energized, if a NO contact fails to open, the remaining NC contact must not close, maintaining a contact gap ≥ 0.5 mm

EN 61810-3 lays down the standard requirements for relays with forcibly guided contacts. This standard defines two types of relay with forcibly guided contacts, namely:

- Type A: Relay whose contacts are all mechanically linked (forcibly guided).

- Type B: Relay containing mechanically linked contacts and contacts which are not mechanically linked.

In the case of relays that include changeover contacts, either the make circuit or the break circuit of a changeover contact can be considered to meet the requirements of this standard.

Models	Number of contacts	Magnetic arc blow-out
RGG.x3X	4	
RGG.x7X	4	•



FOR CONFIGURATION OF PRODUCT CODE, SEE "ORDERING SCHEME" TABLE



Coil data	RGGExyX / RGGFxyX	RGGRxyX ⁽³⁾
Nominal voltages Un	DC: 12-24-48-110-125-132-144-230 ⁽¹⁾	DC: 24-36-72-110 ⁽¹⁾
Consumption at Un (DC/AC)	3.5W	
Operating range	80...120% Un	70...125% Un
Type of duty	Continuous	
Drop-out voltage ⁽²⁾	DC : > 5% Un	

(1) Other values on request.

(2) Limit value for supply voltage, expressed as % of the nominal value, beneath which the relay is certainly de-energized.

(3) Suitable for application on ROLLING STOCK. Operating range in accordance with EN60077.



Contact data														
	Number and type	4 SPDT, form C												
Current	Nominal ⁽¹⁾	12A												
	Maximum peak ⁽²⁾	20A for 1min - 40A for 1s												
	Maximum pulse ⁽²⁾	150A for 10ms												
Example of electrical life expectancy ⁽³⁾		RGG.x3: 0.5A - 110Vdc - L/R 40ms - 10 ⁵ operations - 1800 operations/hour RGG.x7: 1A - 110Vdc - L/R 40ms - 10 ⁵ operations - 1800 operations/hour 1A - 110Vdc - L/R 40ms - 2x10 ⁵ operations - 600 operations/hour												
Minimum load	Standard contacts	200mW (10V, 10mA)												
	Gold-plated contact	50mW (5V, 5mA)												
Maximum breaking voltage		350 VDC / 440 VAC												
Contact material		AgCdO												
Operating time at Un (ms) ⁽⁴⁾		<table border="1"> <thead> <tr> <th>RGG.13X-17X-43X-47X</th> <th>RGG.33X-37X-63X-67X-53X-57X</th> </tr> </thead> <tbody> <tr> <td>DC</td> <td>DC</td> </tr> <tr> <td>Pick-up (NC contact opening)</td> <td>≤ 20</td> </tr> <tr> <td>Pick-up (NO contact closing)</td> <td>≤ 35</td> </tr> <tr> <td>Drop-out (NO contact opening)</td> <td>≤ 10</td> </tr> <tr> <td>Drop-out (NC contact closing)</td> <td>≤ 53</td> </tr> </tbody> </table>	RGG.13X-17X-43X-47X	RGG.33X-37X-63X-67X-53X-57X	DC	DC	Pick-up (NC contact opening)	≤ 20	Pick-up (NO contact closing)	≤ 35	Drop-out (NO contact opening)	≤ 10	Drop-out (NC contact closing)	≤ 53
	RGG.13X-17X-43X-47X	RGG.33X-37X-63X-67X-53X-57X												
	DC	DC												
	Pick-up (NC contact opening)	≤ 20												
	Pick-up (NO contact closing)	≤ 35												
Drop-out (NO contact opening)	≤ 10													
Drop-out (NC contact closing)	≤ 53													
	≤ 20													
	≤ 40													
	≤ 55													
	≤ 85													

(1) On all contacts simultaneously, reduction of 30%.

(2) The max. peak and pulse currents are those currents that can be handled, for a specified time, by the contact. They do not refer to steady or interrupted currents.

(3) For other examples, see electrical life expectancy curves.

(4) Unless specified otherwise, the operating time signifies until stabilization of the contact (including bounces).



Insulation		
Insulation resistance (at 500Vdc)	between electrically independent circuits and between these circuits and ground	> 10,000 MΩ
	between open contact parts	> 10,000 MΩ
Withstand voltage at industrial frequency	between electrically independent circuits and between these circuits and ground	2 kV (1 min.) - 2.2kV (1 s)
	between open contact parts	2 kV (1 min.) - 2.2kV (1 s)
	between adjacent contacts	2 kV (1 min.) - 2.2kV (1 s)
Impulse withstand voltage (1.2/50μs - 0.5J)	between electrically independent circuits and between these circuits and ground	5 kV
	between open contact parts	4 kV

Mechanical specifications



	Mechanical life expectancy	10x10 ⁶ operations
Maximum switching rate	Mechanical	3600 operations/h
	Degree of protection	IP40
	Dimensions (mm)	45x50x86 ⁽¹⁾
	Weight (g)	280

1. Output terminals excluded.

Environmental specifications



Operating temperature	Standard	-25 to 55°C
	Version for railways, rolling stock	-25 to 70°C
Storage and shipping temperature		-50 to 85°C
Relative humidity		Standard : 75% RH - Tropicalized : 95% RH
Fire behaviour		V0

Standards and reference values



EN 61810-1, EN 61810-2, EN 61810-7 EN 60695-2-10 EN 60529 EN 50082-2 EN 61810-3, Type A	Electromechanical elementary relays Fire behaviour Degree of protection provided by enclosures Electromagnetic compatibility Relays with forcibly guided (mechanically linked) contacts
---	---

Unless otherwise specified, the products are designed and manufactured according to the requirements of the above-mentioned European and International standards. In accordance with EN 61810-1, all items of technical data are referred to ambient temperature 23 °C, atmospheric pressure 96kPa and 50% humidity. Tolerance for coil resistance, nominal electrical input and nominal power is ±7%.

Railways, rolling stock - Standards

Applicable to RGGRX version



EN 60077 EN 61373 ⁽¹⁾ EN 45545-2 ASTM E162, E662	Electric equipment for rolling stock - General service conditions and general rules Shock and vibration tests, Cat 1, Class B Fire behaviour, Cat E10, Requirement R26, V0 Fire behaviour
--	--

(1) Permissible opening time of contacts on a de-energized relay $t < 3ms$.

Railways, rolling stock - Special operating ranges



Nominal voltage	Minimum pick-up voltage	Maximum operating voltage	Order symbol ⁽¹⁾
24 Vdc	16,8	32	Z01
36 Vdc	23	42,5	Z01
72 Vdc	55	96	Z01
110 Vdc	77	144	Z01

(1) To order the relay with the special operating range, indicate the "Z0x" symbol in the "Keying position" field of the ordering scheme. The special range may be subject to operating specifications different from standard specifications. Please contact us for further information.



Configurations - Options

TROPICALIZATION	Surface treatment of the coil with protective coating for use with RH 95%.
GOLD PLATING	Surface treatment of the contacts, blades and output terminals with gold-cobalt alloy $\geq 2\mu$. This treatment ensures long-term capacity of the contact to conduct lower currents.
LED	LED indicator showing presence of power supply, wired in parallel with the coil.
FLYBACK DIODE	Component connected in parallel with the coil (type 1N4007) designed to suppress overvoltages generated by the coil when de-energized.
TRANSIL	Non-polarized component connected in parallel with the coil. Behaviour is similar to that of a varistor, with faster operating times.
LOW TEMPERATURE	minimum operating temperature -50°C , only for rolling stock version (option L)



Ordering scheme

Product code	Application ⁽¹⁾	Configuration A	Configuration B	Type of power supply	Nominal voltage (V) ⁽²⁾	Finish ⁽³⁾
RGG	E: Energy	1: Standard	3X: 4 SPDT contacts	C: Vdc	012 - 024 - 036 048 - 072 - 110 125 - 132 - 144 220	Z0x: Special operating range (only for "R" applications) T: Tropicalized coil L: Low temperature
	F: Railway, Fixed Equipment	2: Gold plating + Diode // + Led	7X: 4 SPDT contacts with magnetic arc blow-out			
	R: Railway, Rolling Stock	3: Diode // 4: Gold plating 5: Led 6: Gold plating + Diode // 7: Diode // + Led 8: Transil 9: Transil + Led 0: Gold plating + Transil + Led				

Example

RGG	E	3	7X	C	048	T
RGGE37X-C048/T = ENERGY series relay with flyback diode, magnetic arc blow-out and 48Vdc tropicalized coil.						
RGG	F	5	3X	C	110	
RGGF53X-C110 = RAILWAY series relay, fixed equipment, with LED indicator and 110Vdc coil.						

(1) ENERGY : all applications except for railway.

RAILWAYS, FIXED EQUIPMENT : application on fixed power systems and electrical railway traction. Construction according to RFI (FS Group) specification no. RFI DPRIM STF IFS TE 143 A, if applicable. For list of RFI approved and conforming products, consult dedicated catalogue "RAILWAY SERIES - RFI APPROVED"

RAILWAYS, ROLLING STOCK: application on board rolling stock (wire-rail-tramway vehicles). Electrical characteristics according to EN60077.

(2) Other values on request.

(3) Optional value: multiple selection possible (e.g. T-L)

Wiring diagram

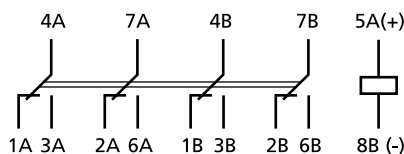

Dimensions

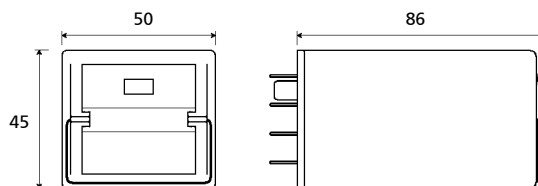

Instantaneous monostable relay

8-12-20 contacts

2.04

RMM SERIES

OVERVIEW

- Plug-in monostable instantaneous relay
- Solid and rugged construction for heavy or intensive duty
- Very high electrical life expectancy and exceptional endurance
- Fitted with mechanical optical contact status indicator as standard
- Lever for manual operation (optional)
- Self-cleaning knurled contacts
- Operation using d.c. or a.c. power supply (directly, without rectifiers or diodes)
- Wide variety of configurations and customizations
- Transparent cover, fixing/pulling screws
- Label holder in cover for customer's use
- Positive mechanical keying for relay and socket

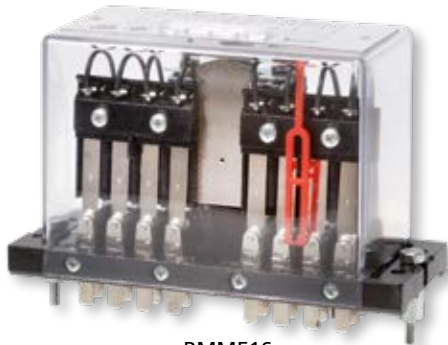

RMME16



RMME17

APPLICATIONS



Shipbuilding



Petroleum industry



Heavy industry



Power generation



Power distribution



Railway equipment

DESCRIPTION

Relays of the RMM series are monostable multipole types with 8, 12 and 20 change-over contacts. RMM relays share the same basic mechanical design as those of the RGM series, and offer the same specifications and performance. These are highly reliable products providing top performance, suitable for applications in particularly harsh and unsettled environments, such as high voltage electricity distribution stations and medium voltage substations. The mechanical design of the relay is such as to allow the development of numerous custom solutions, in the event that the standard models do not fully respond to the required performance parameters. Thanks to its exceptional breaking capacity, the relay is suitable for controlling heavy duty loads with intensive switching frequency, where safety and continuity of operation are all-important. A product of proven reliability, as demonstrated by its use for over 40 years in electrical energy transport and distribution systems, and fixed equipment used in the railway sector. Benefiting also from careful selection of materials, coupled with the technical and professional skills of human resources involved in design and production, this family of relays has found favour with many important and high profile customers.

Versatility in manufacture allows the production of relays with any voltage in the range 12 to 250VDC/440VAC, and with a variety of operating ranges adaptable to different application requirements. The contacts used are of a type designed to give good levels of performance both with high and strongly inductive d.c. loads, and with particularly low loads. Inclusion of the magnetic arc blow-out function (optional) helps to achieve a considerable increase in breaking capacity, whilst the knurled contacts ensure not only better self-cleaning characteristics, but also lower ohmic resistance thanks to multiple points of electrical connection, thereby extending the electrical life expectancy of the component. All models offer the facility of manual operation, so that tests can be performed even in the absence of electrical power. To ensure that the relay remains firmly anchored to the sockets, these are equipped with fixing screws, so that there is no need for the use of retaining clips. Like all AMRA relays, models of the RMM series are assembled as part of a controlled manufacturing process in which every step of production is verified by the next step in succession. In effect, each relay is calibrated and tested individually, by hand, in such a way as to guarantee the maximum level of reliability possible.

Models	Number of contacts	Magnetic arc blow-out
RMM.x2	8	
RMM.x6	8	•
RMM.x3	12	
RMM.x7	12	•
RMM.x4	20	
RMM.x8	20	•

FOR CONFIGURATION OF PRODUCT CODE, SEE "ORDERING SCHEME" TABLE

Coil data	RMM.x2-x6	RMM.x3-x4-x7-x8
Nominal voltages Un	DC : 12-24-48-110-125-132-144-220 ⁽¹⁾ - AC : 12-24-48-110-125-220-230-380-440 ⁽¹⁻²⁾	
Consumption at Un (DC/AC)	3W / 6.5VA ⁽³⁾ - 11.5VA ⁽⁴⁾	6W / 15VA ⁽³⁾ - 25VA ⁽⁴⁾
Operating range	DC: 80...120% Un - AC: 85...110% Un	
Type of duty	Continuous	
Drop-out voltage ⁽⁵⁾	DC : > 5% Un - AC : > 15% Un	

(1) Other values on request.

(2) Maximum value, a.c. = 380V 50Hz - 440V 60Hz.

(3) In operation.

(4) On pick-up.

(5) Limit value for supply voltage, expressed as % of the nominal value, beneath which the relay is certain to be de-energized.

Contact data							
Number and type	8 - 12 - 20 SPDT, form C						
Current	Nominal ⁽¹⁾	10A					
	Maximum peak ⁽²⁾	20A for 1min - 40A for 1s					
	Maximum pulse ⁽²⁾	150A for 10ms					
Example of electrical life expectancy ⁽³⁾	RMM.x2-x3-x4 : 0.5A - 110Vdc - L/R 40ms - 10 ⁵ operations - 1800 operations/hour RMM.x6-x7-x8 : 1A - 110 Vdc - L/R 40ms - 10 ⁵ operations - 1800 operations/hour						
Minimum load	Standard contacts	200mW (10V, 10mA)					
	Gold-plated contacts	50mW (5V, 5mA)					
Maximum breaking voltage	350 VDC / 440 VAC						
Contact material	AgCdO						
Operating time at Un (ms) ⁽⁴⁾		RMM. 12-16-42-46	RMM. 13-17-43-47	RMM. 14-18-44-48	RMM. 32-36-62-66	RMM. 33-37-63-67	RMM. 34-38-64-68
	Pick-up (NC contact opening)	DC - AC ≤ 15 - ≤ 10	DC - AC ≤ 13 - ≤ 10	DC - AC ≤ 14 - ≤ 10	DC ≤ 15	DC ≤ 13	DC ≤ 14
	Pick-up (NO contact closing)	≤ 40 - ≤ 32	≤ 37 - ≤ 35	≤ 45 - ≤ 35	≤ 40	≤ 37	≤ 40
	Drop-out (NO contact opening)	≤ 12 - ≤ 30	≤ 12 - ≤ 30	≤ 8 - ≤ 35	≤ 104	≤ 31	≤ 35
	Drop-out (NC contact closing)	≤ 64 - ≤ 110	≤ 70 - ≤ 80	≤ 42 - ≤ 73	≤ 150	≤ 80	≤ 75

(1) On all contacts simultaneously, reduction of 30%.

(2) Maximum peak and pulse currents are those currents that can be handled, for a specified time, by the contact. They do not refer to steady or interrupted currents.

(3) For other examples, see electrical life expectancy curves.

(4) Unless specified otherwise, operating times are understood as comprising stabilization of the contact (inclusive of bounces).

Insulation		
Insulation resistance (at 500Vdc)	between electrically independent circuits and between these circuits and ground	> 10,000 MΩ
	between open contact parts	> 10,000 MΩ
Withstand voltage at industrial frequency	between electrically independent circuits and between these circuits and ground	2 kV (1 min.) - 2.2kV (1 s)
	between open contact parts	2 kV (1 min.) - 2.2kV (1 s)
	between adjacent contacts	2 kV (1 min.) - 2.2kV (1 s)
Impulse withstand voltage (1.2/50μs - 0.5J)	between electrically independent circuits and between these circuits and ground	5 kV
	between open contact parts	5 kV

Mechanical specifications		RMM.x2-x6	RMM.x3-x7	RMM.x4-x8
Mechanical life expectancy		20x10 ⁶ operations		
Maximum switching rate	Mechanical	3600 operations/hour		
Degree of protection		IP40		
Dimensions (mm)		132x58x84 ⁽¹⁾	188x58x84 ⁽¹⁾	300x58x84 ⁽¹⁾
Weight (g)		430	720	1100

(1) Output terminals excluded.

Environmental specifications	
Operating temperature	-25 to 55°C
Storage and shipping temperature	-25 to 70°C
Relative humidity	Standard : 75% RH - Tropicalized : 95% RH
Fire behaviour	V0

Standards and reference values	
EN 61810-1, EN 61810-2, EN 61810-7 EN 60695-2-10 EN 50082-2 EN 60529	Electromechanical elementary relays Fire behaviour Electromagnetic compatibility Degree of protection provided by enclosures

Unless otherwise specified, products are designed and manufactured according to the requirements of the European and International standards indicated above.
In accordance with EN 61810-1, all items of technical data are referred to ambient temperature 23 °C, atmospheric pressure 96kPa and 50% humidity.
Tolerance for coil resistance, nominal electrical input and nominal power is ±7%.

Configurations - Options	
TROPICALIZATION	Surface treatment of the coil with protective coating for use with RH 95%.
GOLD PLATING	Surface treatment of contacts, blades and output terminals with gold-cobalt, thickness ≥ 2μ. This treatment ensures long-term capacity of the contact to conduct lower currents.
LED	Luminous indicator showing presence of power supply, wired in parallel with the coil, as alternative to mechanical optical indicator.
FLYBACK DIODE	Component connected in parallel with the coil (type 1N4007) designed to suppress overvoltages generated by the coil when de-energized.
LEVER FOR MANUAL OPERATION	Allows manual operation of the relay, with the cover closed, using a screwdriver.

Ordering scheme

Product code	Application ⁽¹⁾	Configuration A	Configuration B	Type of power supply	Nominal voltage (V) ⁽²⁾	Finish ⁽³⁾	Keying position code ⁽⁴⁾
RMM	E: Energy F: Railway Fixed Equipment	1: Standard 3: Diode // 4: Gold plating 5: Led 6: Gold plating + Diode // 7: Diode // + Led	2: 8 SPDT contacts 3: 12 SPDT contacts 4: 20 SPDT contacts 6: 8 SPDT contacts with magnetic arc blow-out 7: 12 SPDT contacts with magnetic arc blow-out 8: 20 SPDT contacts with magnetic arc blow-out	C: Vdc A: Vac 50 Hz H: Vac 60 Hz	012 - 024 - 048 110 - 125 - 132 144 - 220 - 230 380 - 440	T: Tropicalized coil M: Manual operation ⁽⁵⁾	xxx

Example	RMM	E	4	7	A	024	M	
	RMME47-A024/M = ENERGY series relay with 20 gold-plated contacts, magnetic arc blow-out, 24Vac coil and manual operating lever.							
	RMM	F	1	3	C	110	T	
RMMF13-C110/T = RAILWAY series relay, fixed equipment, 12 contacts with 110Vdc tropicalized coil.								

(1) ENERGY: all applications except for railway.

RAILWAYS, FIXED EQUIPMENT: application on fixed power systems and electrical railway traction. For list of RFI compliant and type-approved products, consult dedicated catalogue "RAILWAY SERIES – RFI APPROVED".

Also available is the STATIONS series, with ENEL approved material meeting LV15/LV16 specifications. For list of ENEL compliant and type-approved products, consult dedicated catalogue "STATIONS SERIES – LV15-LV16-LV20".

(2) Other values on request. Voltages 380V and 440V available as Vac only.

(3) Optional value. Multiple selection possible (e.g. TM).

(4) Optional value. Positive mechanical keying is applied according to the manufacturer's product model.

(5) With manual operation, no optical indicator.

Wiring diagram

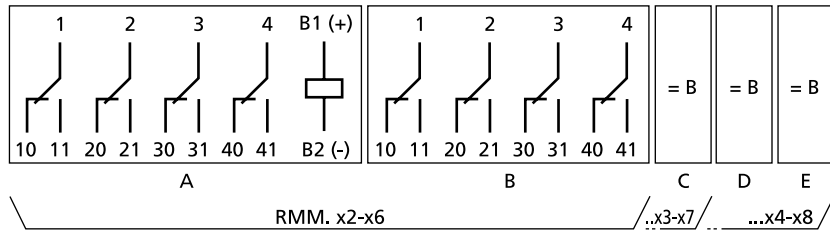

Dimensions

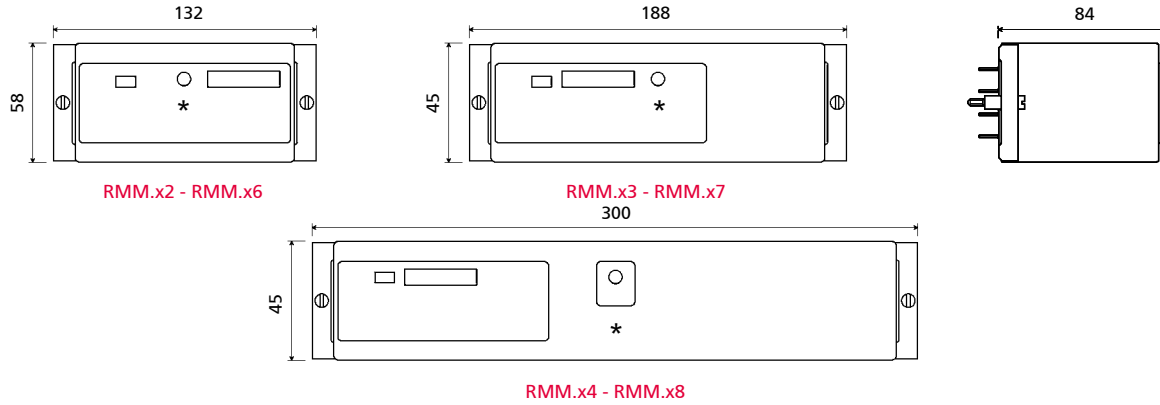

(*) Models with manual operating lever (optional) are provided with a hole at the front giving access to the lever. The position of the data plate holder and the mechanical optical indicator can vary depending on the version.

Electrical life expectancy

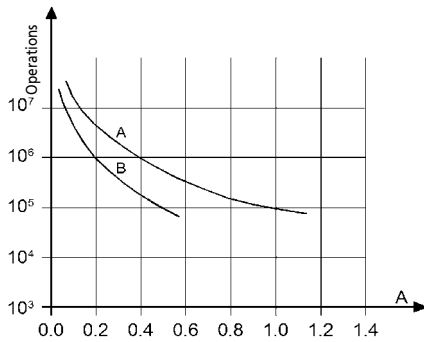

Contact loading: 110Vdc, L/R 40 ms
 Curve A: RMM.x6-7-8
 Curve B: RMM.x2-3-4

RMM.x2 - RMM.x3 - RMM.x4			
U	I (A)	L/R (ms)	Operations
110Vdc	0.5	40	100,000
110Vdc	0.6	10	300,000
120Vdc	0.7	40	50,000
125Vdc	1.2	0	1,000,000
220Vdc	0.1	40	100,000
220Vdc	0.25	10	100,000
U	I (A)	cosφ	Operations
110Vac	1	1	2,000,000
110Vac	1	0.5	1,500,000
110Vac	5	1	1,000,000
110Vac	5	0.5	500,000
220Vac	0.5	1	2,000,000
220Vac	1	0.5	600,000
220Vac	5	1	650,000
220Vac	5	0.5	600,000

RMM.x6 - RMM.x7 - RMM.x8			
U	I (A)	L/R (ms)	Operations
24Vdc	1	0	7,000,000
24Vdc	1	40	3,000,000
24Vdc	2	40	2,000,000
24Vdc	5	0	3,000,000
24Vdc	5	40	200,000
24Vdc	9	0	800,000
U	I (A)	cosφ	Operations
48Vdc	5	20	200,000
110Vdc	0.4	40	1,000,000
110Vdc	1	40	100,000
110Vdc	10	0	100,000
U	I (A)	cosφ	Operations
220Vac	5	0.5	100,000
220Vac	10	1	100,000
230Vac	1	0.7	2,500,000
230Vac	3	0.7	1,200,000

Switching frequency: 1,200 operations/hour

Sockets		RMM.x2-x6	RMM.x3-x7	RMM.x4-x8
Type of installation	Type of outputs			
Wall or DIN H35 rail mounting	Screw	PAVM321	PAVM481	PAVM801
Flush mounting	Double faston (4.8 x 0.8 mm)	PRDM321	PRDM481	PRDM801
	Screw	PRVM321	PRVM481	PRVM801

Mounting tips

The preferred mounting position is on the wall, with the relay positioned horizontally in the reading direction on the nameplate. For correct use of the relays, they should be spaced apart by at least 20 mm in the vertical direction. This is to allow correct upward dissipation of the heat generated by the coil. Set these distances according to the socket used. Distances can be reduced depending on the environmental conditions during operation, and on the relay duty cycle. Retaining clips are not required, as a secure connection is guaranteed by the fixing screws. These same screws also serve to facilitate installation and removal of the relay. To ensure correct use, the screws must be tightened / loosened in alternating sequence, by degrees. No special maintenance is required. Condensation can form inside the relay when powered up and the outside ambient temperature is cold; this is quite normal and does not affect the operation of the relay. The plastic materials of the relay do not possess hygroscopic properties.

Bistable (latching) relay

3-4 contacts

2.05

RGB SERIES

OVERVIEW

- Plug-in instantaneous bistable relay
- Solid and rugged construction for heavy or intensive duty
- Very high electrical life expectancy and notable endurance
- Magnetic arc blow-out for higher breaking capacity
- Fitted with mechanical optical contact status indicator as standard
- Lever for manual operation (optional)
- Self-cleaning knurled contacts
- Pulsed or permanent power supply, a.c. or d.c.
- Wide variety of configurations and customizations
- Retaining clip for secure locking of relay on socket
- Label holder in cover for customer's use
- Positive mechanical keying for relay and socket



RGBE13



RGBE14

APPLICATIONS



Shipbuilding



Petroleum industry



Heavy industry



Power generation



Power distribution



Railway equipment

DESCRIPTION

Bistable relays of the RGB series are reliable products offering high performance. These components have 2 stable operating states, which means that they are able to hold their current position in the event of a power supply failure, thereby guaranteeing that this can be stored as "memory" information should system faults occur during subsequent cycles. Given their superior reliability and durability, RGB relays are capable of filling roles that call for a high level of responsibility; in effect, they are used in environments where continuous duty is an essential requirement (e.g. high voltage electricity distribution stations and medium voltage substations). All models are equipped with an automatic coil de-energization system, operated mechanically or electronically, designed to reduce the power consumption of the device to zero once the operating cycle has been completed. Thanks to its exceptional breaking capacity, the relay is suitable for controlling heavy duty loads with intensive switching frequency, where safety and continuity of operation are all-important. A product of proven reliability, as demonstrated by its use for over 40 years in electrical energy transport and distribution systems, and fixed equipment used in the railway sector. Benefiting also from careful selection of materials, coupled with the technical and professional skills of human resources involved in design and production, this family of relays has found favour with many important and high profile customers.

The versatility in manufacture allows producing relays with any voltage in the range 12 to 250VDC/440VAC and with a great number of operating ranges adaptable to the various application requirements.

The contacts used are of a type designed to give notable levels of performance both with high and strongly inductive loads, and with particularly low loads. Knurled contacts ensure not only better self-cleaning characteristics, but also lower ohmic resistance thanks to multiple points of electrical connection, thereby extending the electrical life expectancy of the component.

In the case of the version with 3 contacts, there is also the facility of manual operation, so that tests can be performed even in the absence of electrical power.

Like all AMRA relays, models of the G series are assembled as part of a controlled manufacturing process in which every step of production is verified by the next step in succession. In effect, each relay is calibrated and tested individually, by hand, in such a way as to guarantee top reliability.

Models	Number of contacts	Power input to coils
RGBEx3	3	Common negative
RGBEx4	4	Coils galvanically separated

FOR CONFIGURATION OF PRODUCT CODE, SEE "ORDERING SCHEME" TABLE

Coil data	
Nominal voltages Un ⁽¹⁾	DC / AC : 12-24-48-110-125-132-144-230-380 ⁽²⁾ -440 ⁽²⁾
Consumption at Un (DC/AC) ⁽³⁾	15W / 15VA
Operating range	80...120% Un
Type of duty	Continuous

Minimum control pulse 50ms.

(1) Other values on request.

(2) Maximum value, a.c. = 380V 50Hz - 440V 60Hz.

(3) Latch and unlatch. Power consumption is zero on completion of the operating cycle, as the coil de-energizes automatically.

Contact data			
Number and type	3 or 4 SPDT, form C		
Current	Nominal ⁽¹⁾	12A	
	Maximum peak ⁽²⁾	20A for 1min - 40A for 1s	
	Maximum pulse ⁽²⁾	150A for 10ms	
Example of electrical life expectancy ⁽³⁾	0.5A - 110Vdc - L/R 40ms - 10 ⁵ operations - 1200 operations/hour		
Minimum load	Standard contacts	200mW (10V, 10mA)	
	Gold-plated contacts	50mW (5V, 5mA)	
Maximum breaking voltage	350 VDC / 440 VAC		
Contact material	AgCdO		
Operating time at Un (ms) ⁽⁴⁾		RGB.13-33-43	RGB.14-34-44
		DC - AC	DC - AC
	Pick-up (NC contact opening)	≤ 9 - ≤ 20	≤ 9 - ≤ 20
	Pick-up (NO contact closing)	≤ 30 - ≤ 35	≤ 30 - ≤ 35
	Drop-out (NO contact opening)	≤ 7 - ≤ 21	≤ 7 - ≤ 21
	Drop-out (NC contact closing)	≤ 45 - ≤ 65	≤ 45 - ≤ 55

(1) On all contacts simultaneously, reduction of 30%.

(2) Maximum peak and pulse currents are those currents that can be handled, for a specified time, by the contact. They do not refer to steady or interrupted currents.

(3) For other examples, see electrical life expectancy curves.

(4) Unless specified otherwise, the operating time signifies until stabilization of the contact (including bounces).

Insulation		
Insulation resistance (at 500Vdc)	between electrically independent circuits and between these circuits and ground	> 10,000 MΩ
	between open contact parts	> 10,000 MΩ
Withstand voltage at industrial frequency	between electrically independent circuits and between these circuits and ground	2 kV (1 min.) - 2.2kV (1 s)
	between open contact parts	2 kV (1 min.) - 2.2kV (1 s)
	between adjacent contacts	2 kV (1 min.) - 2.2kV (1 s)
Impulse withstand voltage (1.2/50μs - 0.5J)	between electrically independent circuits and between these circuits and ground	5 kV
	between open contact parts	5 kV

Mechanical specifications		RGB.x3	RGB.x4
Mechanical life expectancy		20x10 ⁶ operations	
Maximum switching rate	Mechanical	900 operations/hour	
Degree of protection		IP40	
Dimensions (mm)		45x50x86 ⁽¹⁾	45x50x112 ⁽¹⁾
Weight (g)		270	350

(1) Output terminals excluded.

Environmental specifications

Operating temperature	-25 to +55°C
Storage and shipping temperature	-25 to +70°C
Relative humidity	Standard : 75% RH - Tropicalized : 95% RH
Fire behaviour	V0

Standards and reference values

EN 61810-1, EN 61810-2, EN 61810-7 EN 60695-2-10 EN 50082-2 EN 60529	Electromechanical elementary relays Fire behaviour Electromagnetic compatibility Degree of protection provided by enclosures
---	---

Unless otherwise specified, products are designed and manufactured according to the requirements of the European and International standards indicated above. In accordance with EN 61810-1, all items of technical data are referred to ambient temperature 23 °C, atmospheric pressure 96kPa and 50% humidity. Tolerance for coil resistance, nominal electrical input and nominal power is $\pm 7\%$.

Configurations - Options

TROPICALIZATION	Surface treatment of the coil with protective coating for use with RH 95%.
GOLD PLATING	Surface treatment of contacts, blades and output terminals with gold-cobalt, thickness $\geq 2\mu$. This treatment ensures long-term capacity of the contact to conduct lower currents.
FLYBACK DIODE	Component connected in parallel with the coil (type 1N4007) designed to suppress overvoltages generated by the coil when de-energized.
LEVER FOR MANUAL OPERATION	Allows manual operation of the relay, with the cover closed, using a screwdriver.

Ordering scheme

Product code	Application ⁽¹⁾	Configuration A	Configuration B	Type of power supply	Nominal voltage (V) ⁽²⁾	Finish ⁽³⁾	Keying position code ⁽⁴⁾
RGB	E: Energy F: Railway Fixed Equipment	1: Standard 3: Diode // 4: Gold plating 6: Gold plating + Diode //	3: 3 SPDT contacts 4: 4 SPDT contacts	C: Vdc A: Vac 50 Hz H: Vac 60 Hz	012 - 024 - 048 110 - 125 - 132 144 - 220 - 230 380 - 440	T: Tropicalized coil M: Manual operation ⁽⁵⁾	xxx

Example	RGB	E	3	3	C	048	T	
	RGBE33-C048/T = ENERGY series relay with 3 SPDT contacts, flyback diode and 48Vdc tropicalized coil.							
	RGB	F	1	4	C	110		SBH
	RGBF14-C110-SBH = RAILWAY series relay, fixed equipment, with 4 SPDT contacts, 110VDC coil and keying position SBH.							

(1) **ENERGY**: all applications except for railway.

RAILWAYS, FIXED EQUIPMENT: application on fixed power systems and electrical railway traction. For list of RFI compliant and type-approved products, consult dedicated catalogue "RAILWAY SERIES – RFI APPROVED".

Also available is the STATIONS series, with ENEL approved material meeting LV15/LV16 specifications. For list of ENEL compliant and type-approved products, consult dedicated catalogue "STATIONS SERIES - LV15-LV16-LV20"

(2) Other values on request. Voltages 380V and 440V available as Vac only.

(3) Optional value. Multiple selection possible (e.g. TM).

(4) Optional value. Positive mechanical keying is applied according to the manufacturer's model.

(5) With manual operation, no optical indicator.

Wiring diagram

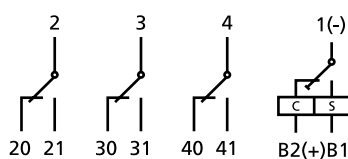

RGB.x3

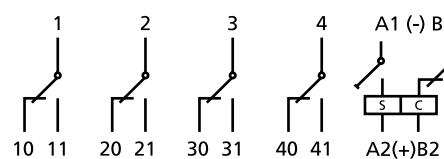

RGB.x4

Dimensions

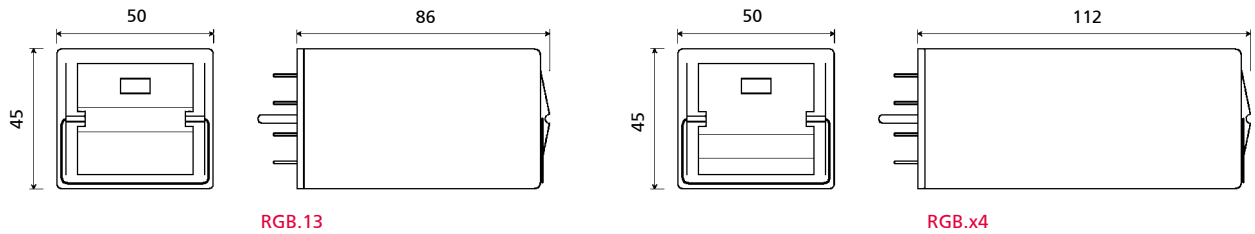

RGB.13

RGB.x4

Electrical life expectancy

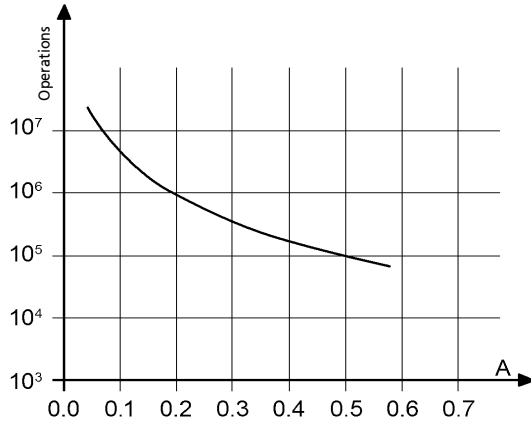

Contact loading: 110Vdc, L/R 40 ms

U	I (A)	L/R (ms)	Operations
110Vdc	0.5	40	100,000
110Vdc	0.6	10	300,000
120Vdc	0.7	40	50,000
125Vdc	1.2	0	1,000,000
220Vdc	0.1	40	100,000
220Vdc	0.25	10	100,000
U	I (A)	cosφ	Operations
110Vac	1	1	2,000,000
110Vac	1	0.5	1,500,000
110Vac	5	1	1,000,000
110Vac	5	0.5	500,000
220Vac	0.5	1	2,000,000
220Vac	1	0.5	600,000
220Vac	5	1	650,000
220Vac	5	0.5	600,000

Switching frequency: 1200 operations/hour

Sockets and retaining clips		Model	RGBEx3	RGBEx4-x5
Type of installation	Type of outputs		Retaining clip	
Wall or DIN rail mounting	Screw	PAVG161	VM1221	VM1222
Flush mounting	Double faston (4.8 x 0.8 mm)	PRDG161		
	Screw	PRVG161		

Mounting tips

The preferred mounting position is on the wall, with the relay positioned horizontally in the reading direction on the nameplate.
For safe and secure operation, it is advisable to use retaining clips.
No special maintenance is required.

Instantaneous bistable (latching) relay - 7 to 20 contacts

2.06

RMB SERIES



RMBE13

OVERVIEW

- Plug-in instantaneous bistable relay
- Solid and rugged construction for heavy or intensive duty
- Very high electrical life expectancy and exceptional endurance
- Pulsed or permanent power supply, a.c. or d.c.
- Self-cleaning knurled contacts
- Fitted with mechanical optical contact status indicator as standard
- Lever for manual operation (optional)
- Wide variety of configurations and customizations
- Transparent cover, fixing/pulling screws
- Label holder in cover for customer's use
- Positive mechanical keying for relay and socket

APPLICATIONS



Shipbuilding



Petroleum industry



Heavy industry



Power generation



Power distribution



Railway equipment

DESCRIPTION

RMB relays are multipole bistable types sharing the same basic mechanical design as those of the RGB series, and offering the same specifications and performance. Available in versions with from 7 to 20 change-over contacts, these highly reliable products provide top performance and are suitable for applications in particularly harsh and unsettled environments, such as high voltage electricity distribution stations and medium voltage substations. An automatic coil de-energization system ensures that power consumption of the relay reduces to zero once the operating cycle has been completed. Versatility in manufacture allows the production of relays with any voltage from 12 to 250VDC/440VAC, and with a variety of operating ranges adaptable to different application requirements. The contacts used are of a type designed to give notable levels of performance both with high and strongly inductive loads, and with particularly low loads; knurled contacts ensure not only better self-cleaning characteristics, but also lower ohmic resistance thanks to multiple points of electrical connection, thereby extending the electrical life expectancy of the component. All models offer the facility of manual operation, so that tests can be performed even in the absence of electrical power. To ensure that the relay remains firmly anchored to the sockets, these are equipped with fixing screws, so that there is no need for the use of retaining clips. A product of proven reliability, as demonstrated by its use for over 40 years in electrical energy transport and distribution systems, and fixed equipment used in the railway sector.

Like all AMRA relays, models of the RMB series are assembled as part of a controlled manufacturing process in which every step of production is verified by the next step in succession. In effect, each relay is calibrated and tested individually, by hand, in such a way as to guarantee top reliability.

Models	Number of contacts	Power input to coils
RMB.x3	7	Common negative
RMBZ12	8	Coils galvanically separated
RMB.x5	11	Common negative
RMBZ13	12	Coils galvanically separated
RMB.x7	19	Common negative
RMBZ14	20	Coils galvanically separated

FOR CONFIGURATION OF PRODUCT CODE, SEE "ORDERING SCHEME" TABLE

Coil data	RMB.x3	RMB.x5-x7	RMBZ12	RMBZ13-14
Nominal voltages Un ⁽¹⁾	DC / AC : 12-24-48-110-125-132-144-230-380 ⁽²⁾ -440 ⁽²⁾			
Consumption at Un (DC/AC) ⁽³⁾	15W / 15VA	30W / 30VA	19W / 19VA	36W / 36VA
Operating range	DC: 80...120% Un - AC: 85...110% Un			
Type of duty	Continuous			

Minimum control pulse: 50ms.

(1) Other values on request.

(2) Maximum value, a.c. = 380V 50Hz - 440V 60Hz.

(3) Latch and unlatch. Power consumption is zero on completion of the operating cycle, as the coil de-energizes automatically.

Contact data	RMB.x3	RMBZ12	RMB.x5	RMBZ13	RMB.x7	RMBZ14
Number and type	7 SPDT, form C	8 SPDT, form C	11 SPDT, form C	12 SPDT, form C	19 SPDT, form C	20 SPDT, form C
Current	10A					
Nominal ⁽¹⁾	20A for 1min - 40A for 1s					
Maximum peak ⁽²⁾	150A for 10ms					
Maximum pulse ⁽²⁾						
Example of electrical life expectancy ⁽³⁾	0.5A - 110Vdc - L/R 40ms - 10 ⁵ operations - 1200 operations/hour					
Minimum load	200mW (10V, 10mA)					
Standard contacts	50mW (5V, 5mA)					
Gold-plated contacts						
Maximum breaking voltage	350 VDC / 440 VAC					
Contact material	AgCdO					
Operating time at Un (ms) ⁽⁴⁾	RMB.x3	RMBZ12	RMB.x5	RMBZ13	RMB.x7	RMBZ14
	DC - AC	DC - AC	DC - AC	DC - AC	DC - AC	DC - AC
Pick-up (NC contact opening)	≤ 8 - ≤ 20	≤ 9 - ≤ 20	≤ 9 - ≤ 20	≤ 10 - ≤ 20	≤ 8 - ≤ 20	≤ 8 - ≤ 20
Pick-up (NO contact closing)	≤ 30 - ≤ 35	≤ 26 - ≤ 37	≤ 32 - ≤ 37	≤ 33 - ≤ 37	≤ 25 - ≤ 35	≤ 25 - ≤ 36
Drop-out (NO contact opening)	≤ 9 - ≤ 25	≤ 8 - ≤ 25	≤ 8 - ≤ 20	≤ 9 - ≤ 22	≤ 8 - ≤ 25	≤ 9 - ≤ 27
Drop-out (NC contact closing)	≤ 56 - ≤ 65	≤ 40 - ≤ 60	≤ 50 - ≤ 60	≤ 36 - ≤ 57	≤ 43 - ≤ 53	≤ 43 - ≤ 58

(1) On all contacts simultaneously, reduction of 30%.

(2) Maximum peak and pulse currents are those currents that can be handled, for a specified time, by the contact. They do not refer to steady or interrupted currents.

(3) For other examples, see electrical life expectancy curves.

(4) Unless specified otherwise, operating times are understood as comprising stabilization of the contact (inclusive of bounces).

Insulation	
Insulation resistance (at 500Vdc)	
between electrically independent circuits and between these circuits and ground	> 10,000 MΩ
between open contact parts	> 10,000 MΩ
Withstand voltage at industrial frequency	
between electrically independent circuits and between these circuits and ground	2 kV (1 min.) - 2.2kV (1 s)
between open contact parts	2 kV (1 min.) - 2.2kV (1 s)
between adjacent contacts	2 kV (1 min.) - 2.2kV (1 s)
Impulse withstand voltage (1.2/50μs - 0.5J)	
between electrically independent circuits and between these circuits and ground	5 kV
between open contact parts	5 kV

Mechanical specifications	RMB.x3-RMBZ12	RMB.x5-RMBZ13	RMB.x7-RMBZ14
Mechanical life expectancy	20x10 ⁶ operations		
Maximum switching rate	900 operations/hour		
Degree of protection	IP40		
Dimensions (mm)	132x58x84 ⁽¹⁾	188x58x84 ⁽¹⁾	300x58x84 ⁽¹⁾
Weight (g)	450	760	1140

(1) Output terminals excluded.

Environmental specifications

Operating temperature	-25 to 55°C
Storage and shipping temperature	-25 to 70°C
Relative humidity	Standard : 75% RH - Tropicalized : 95% RH
Fire behaviour	V0

Standards and reference values

EN 61810-1, EN 61810-2, EN 61810-7 EN 60695-2-10 EN 50082-2 EN 60529	Electromechanical elementary relays Fire behaviour Electromagnetic compatibility Degree of protection provided by enclosures
---	---

Unless otherwise specified, products are designed and manufactured according to the requirements of the European and International standards indicated above. In accordance with EN 61810-1, all items of technical data are referred to ambient temperature 23 °C, atmospheric pressure 96kPa and 50% humidity. Tolerance for coil resistance and nominal power is $\pm 7\%$.

Configurations - Options

TROPICALIZATION	Surface treatment of the coil with protective coating for use with RH 95%.
GOLD PLATING	Surface treatment of contacts, blades and output terminals with gold-cobalt, thickness $\geq 2\mu$. This treatment ensures long-term capacity of the contact to conduct lower currents.
FLYBACK DIODE	Component connected in parallel with the coil (type 1N4007) designed to suppress overvoltages generated by the coil when de-energized.
LEVER FOR MANUAL OPERATION	Allows manual operation of the relay, with the cover closed, using a screwdriver.

Ordering scheme

Product code	Application ⁽¹⁾	Configuration A	Configuration B	Type of power supply	Nominal voltage (V) ⁽²⁾	Finish ⁽³⁾	Keying position code ⁽⁴⁾
RMB	E: Energy F: Railway Fixed Equipment	1: Standard 3: Diode // 4: Gold plating 6: Gold plating + Diode//	3: 7 SPDT contacts 5: 11 SPDT contacts 7: 19 SPDT contacts	C: Vdc A: Vac 50 Hz H: Vac 60 Hz	012 - 024 - 048 110 - 125 - 132 144 - 220 - 230 380 - 440	T: Tropicalized coil M: Manual operation ⁽⁶⁾	xxx
		Z12 - 8 SPDT contacts ⁽⁵⁾ Z13 - 12 SPDT contacts ⁽⁵⁾ Z14 - 20 SPDT contacts ⁽⁵⁾					

Example	RMB	E	4	3	C	110	SAH	
	RMBE43-C110-SAH = ENERGY series relay, with 7 SPDT gold-plated contacts, 110Vdc coil and keying position SAH							
	RMB	F	1	4	C	110		
	RMBF15-C110 = RAILWAY series relay, fixed equipment, with 11 SPDT contacts, 110VDC coil							
	RMB	Z	1	2	C	110	T	
RMBZ12-C220 = Relay with 8 SPDT contacts, 110VDC tropicalized coil								

(1) ENERGY: all applications except for railway.

RAILWAYS, FIXED EQUIPMENT: application on fixed power systems and electrical railway traction. For list of RFI approved and conforming products, consult dedicated catalogue "RAILWAY SERIES – RFI APPROVED".

Also available is the STATIONS series, with ENEL approved material meeting LV15/LV16 specifications. For list of ENEL compliant and type-approved products, consult dedicated catalogue "STATIONS SERIES – LV15-LV16-LV20".

(2) Other values on request. Voltages 380V and 440V available as Vac only.

(3) Optional value. Multiple selection possible (e.g. TM).

(4) Optional value. Positive mechanical keying is applied according to the manufacturer's model.

(5) Suitable for "E" and "F" applications. Gold-plated (2μ) contacts and terminals available on request.

(6) With manual operation, no optical indicator.

Wiring diagram

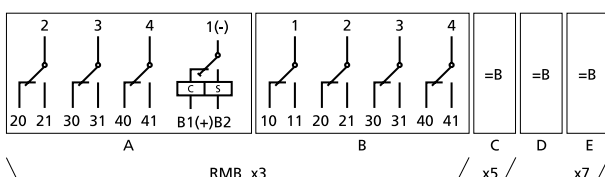

RMB.x3-5-7

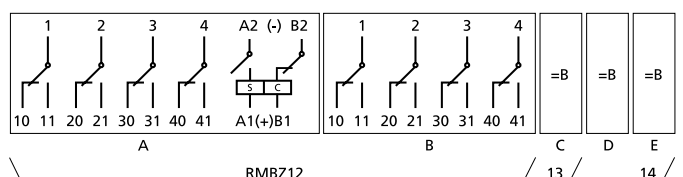

RMBZ12-13-14

Dimensions

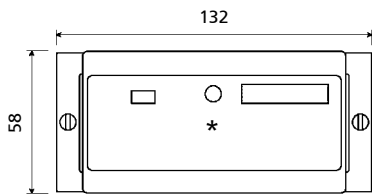

RMB.x3 - RMBZ12

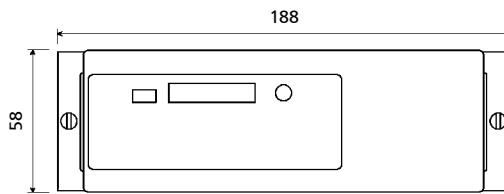

RMB.x5 - RMBZ13

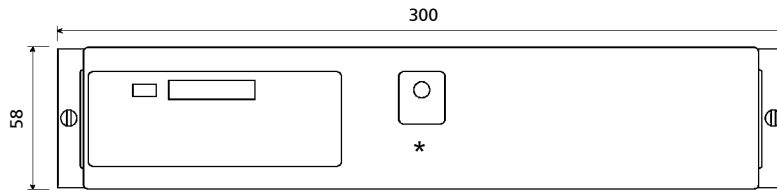
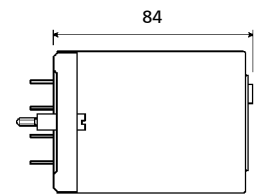

RMB.x7 - RMBZ14

(*) Models with manual operating lever (optional) are provided with a hole at the front giving access to the lever. The position of the data plate holder and the mechanical optical indicator can vary depending on the version.

Electrical life expectancy

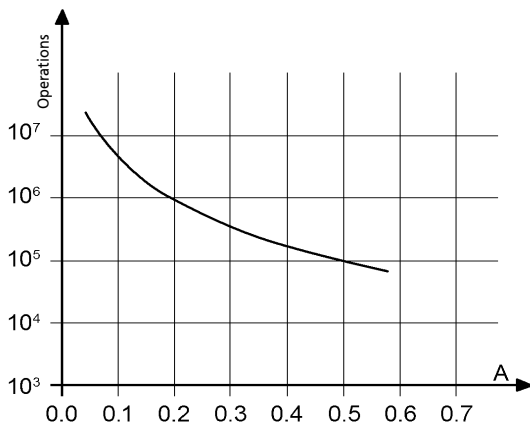

Contact loading: 110Vdc, L/R 40 ms

U	I (A)	L/R (ms)	Operations
110Vdc	0.5	40	100,000
110Vdc	0.6	10	300,000
120Vdc	0.7	40	50,000
125Vdc	1.2	0	1,000,000
220Vdc	0.1	40	100,000
220Vdc	0.25	10	100,000
U	I (A)	cosφ	Operations
110Vac	1	1	2,000,000
110Vac	1	0.5	1,500,000
110Vac	5	1	1,000,000
110Vac	5	0.5	500,000
220Vac	0.5	1	2,000,000
220Vac	1	0.5	600,000
220Vac	5	1	650,000
220Vac	5	0.5	600,000

Switching frequency: 1,200 operations/hour

Sockets and retaining clips		RMB.x3-Z12	RMB.x5-Z13	RMB.x7-Z14
Type of installation	Type of outputs			
Wall or DIN rail mounting	Screw	PAVM321	PAVM481	PAVM801
	Double faston (4.8 x 0.8 mm)	PRDM321	PRDM481	PRDM801
Flush mounting	Screw	PRVM321	PRVM481	PRVM801

Mounting tips

The preferred mounting position is on the wall, with the relay positioned horizontally in the reading direction on the nameplate. Retaining clips are not required, as a secure connection is guaranteed by the fixing screws. These same screws also serve to facilitate installation and removal of the relay. To ensure correct use, the screws must be tightened / loosened in alternating sequence, by degrees. No special maintenance is required. Condensation can form inside the relay when powered up and the outside ambient temperature is cold; this is quite normal and does not affect the operation of the relay. The plastic materials of the relay do not possess hygroscopic properties.

Relays with coil continuity test, monostable and bistable

2.07

RMN • RMD SERIES

OVERVIEW

- Plug-in relay with coil continuity self-test feature, in monostable and bistable versions
- Solid and rugged construction for heavy or intensive duty
- Very high electrical life expectancy and notable endurance
- Self-cleaning knurled contacts
- Fitted with mechanical optical contact status indicator as standard
- Operation using d.c. or a.c. power supply (directly, without rectifiers or diodes)
- Wide variety of configurations and customizations
- Transparent cover, fixing/pulling screws
- Label holder in cover for customer's use
- Positive mechanical keying for relay and socket



RMNE16

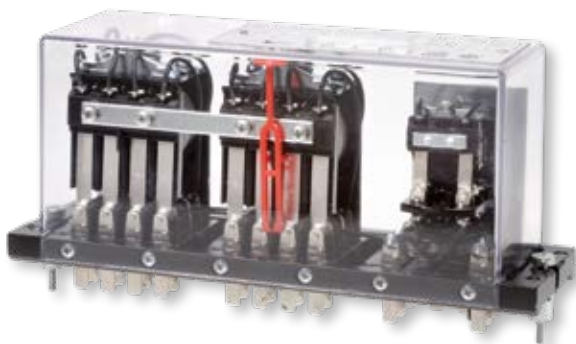

RMNE17

APPLICATIONS



Shipbuilding



Petroleum industry



Heavy industry



Power generation



Power distribution



Railway equipment

DESCRIPTION

Relays of the RMN (MONOSTABLE) and RMD (BISTABLE) series are equipped with a function for testing the continuity of the coil. The coils of the main relay can be monitored by a built-in auxiliary relay, which indicates the readiness of the main relay to perform the next operation, that is to say by physically testing the continuity of the coils. The effect is to create a system for supervising and monitoring the relay, and determining whether or not it is still operational. There are two ways of monitoring continuity of the coils: Periodic test (accomplished by pressing an external button, installed by the customer) or Continuous check (RMN series only, by way of an external switch installed by the customer).

RMN and RMD relays are derived from the G series, and offer the same specifications and performance. The mechanical design of the relay is such as to allow the development of numerous custom solutions, in the event that the standard models do not fully respond to the required performance parameters. A built-in mechanical optical indicator monitors the status of the relay. The contacts used are of a type designed to give good levels of performance both with high and strongly inductive d.c. loads, and with particularly low loads such as interface signals; inclusion of the magnetic arc blow-out function (RMN) helps to achieve a considerable increase in breaking capacity. Knurled contacts ensure not only better self-cleaning characteristics, but also lower ohmic resistance thanks to multiple points of electrical connection, thereby extending the electrical life expectancy of the component.

Typical sectors of use are among the most demanding, such as, for example, electricity generating stations, electrical transformer stations, fixed equipment for railways, or industries using continuous production processes (chemical and petrochemical, rolling mills, cement factories, etc.). The performance and reliability of the product have secured its approval with ENEL and other multi-utilities.

Like all AMRA relays, models of the series with coil continuity test are assembled as part of a controlled manufacturing process in which every step of production is verified by the next step in succession. In effect, each relay is calibrated and tested individually, by hand, in such a way as to guarantee top reliability.

Models	Monostable	Bistable	Number of contacts		Magnetic arc blow-out
			main	diagnostics	
RMN.x6	•		4	2	•
RMN.x7	•		8	2	•
RMN.x9	•		16	2	•
RMD.x1		•	4	2	
RMD.x2		•	8	2	
RMD.x4		•	16	2	

FOR CONFIGURATION OF PRODUCT CODE, SEE "ORDERING SCHEME" TABLE

Coil data	RMN.x6	RMN.x7-x9	RMD.x1	RMD.x2-x4
Nominal voltages Un	DC/AC : 12-24-48-110-125-132-144-220 AC : 230-380-440 ⁽¹⁻²⁾		DC : 12-24-48-110-125-132-144-230 ⁽¹⁾	
Consumption at Un (DC/AC)	3W / 6.5VA ⁽³⁾ - 11.5VA ⁽⁴⁾	6W / 15VA ⁽³⁾ - 25VA ⁽⁴⁾	15W ⁽⁵⁾	30W ⁽⁵⁾
Operating range	DC: 80...120% Un - AC: 85...110% Un			
Type of duty	Continuous			
Drop-out voltage ⁽⁶⁾	DC : > 5% Un - AC : > 15% Un		-	

For bistable versions: minimum control pulse: 100 ms

(1) Other values on request.

(2) Maximum value, a.c.. = 380V 50Hz - 440V 60Hz.

(3) In operation.

(4) On pick-up.

(5) During latch and unlatch. Power consumption is zero on completion of the operating cycle, as the coil de-energizes automatically.

(6) Limit value for supply voltage, expressed as % of the nominal value, beneath which the relay is certain to be de-energized.

Contact data		4 - 8 - 16 SPDT, form C (main relay) + 2 SPDT, form C (diagnostics relay)					
Current	Number and type	4 - 8 - 16 SPDT, form C (main relay) + 2 SPDT, form C (diagnostics relay)					
	Nominal ⁽¹⁾	10A (main contacts) - 5A (diagnostics contacts)					
	Maximum peak ⁽²⁾	20A for 1min - 40A for 1s (main contacts)					
Example of electrical life expectancy ⁽³⁾	Maximum pulse ⁽²⁾	150A for 10ms (diagnostics contacts)					
	Standard contacts	RMN.x6-x7-x9 : 1A - 110Vdc - L/R 40ms - 10 ⁵ operations - 1,800 operations/hour					
	Gold-plated contact	RMD.x1-x2-x4: 0.5A - 110 Vdc - L/R 40ms - 10 ⁵ operations - 1,800 operations/hour					
Minimum load	Standard contacts	200mW (10V, 10mA)					
	Gold-plated contact	50mW (5V, 5mA)					
Maximum breaking voltage		350 VDC / 440 VAC					
Contact material		AgCdO					
Operating time at Un (ms) ⁽⁴⁾		RMN.x6	RMN.x7	RMN.x9	RMD.x1	RMD.x2	RMD.x4
	Pick-up (NC contact opening)	DC - AC	DC - AC	DC - AC	DC	DC	DC
	Pick-up (NO contact closing)	≤ 16 - ≤ 11	≤ 14 - ≤ 11	≤ 15 - ≤ 12	≤ 10	≤ 10	≤ 10
	Drop-out (NO contact opening)	≤ 42 - ≤ 33	≤ 39 - ≤ 37	≤ 38 - ≤ 33	≤ 30	≤ 30	≤ 30
	Drop-out (NC contact closing)	≤ 13 - ≤ 31	≤ 13 - ≤ 31	≤ 10 - ≤ 28	≤ 10	≤ 10	≤ 10
		≤ 66 - ≤ 114	≤ 70 - ≤ 83	≤ 45 - ≤ 74	≤ 40	≤ 40	≤ 40

(1) On all contacts simultaneously, reduction of 30%.

(2) Maximum peak and pulse currents are those currents that can be handled, for a specified time, by the contact. They do not refer to steady or interrupted currents.

(3) For other examples, see electrical life expectancy curves.

(4) Unless specified otherwise, operating times are understood as comprising stabilization of the contact (inclusive of bounces).

Insulation	
Insulation resistance (at 500Vdc) between electrically independent circuits and between these circuits and ground	> 10,000 MΩ
between open contact parts	> 10,000 MΩ
Withstand voltage at industrial frequency between electrically independent circuits and between these circuits and ground	2 kV (1 min.) - 2.2kV (1 s)
between open contact parts	2 kV (1 min.) - 2.2kV (1 s)
between adjacent contacts	2 kV (1 min.) - 2.2kV (1 s)
Impulse withstand voltage (1.2/50μs - 0.5J) between electrically independent circuits and between these circuits and ground	5 kV
between open contact parts	5 kV

Mechanical specifications		RMN.x6 - RMD.x1	RMN.x7 - RMD.x2	RMN.x9 - RMD.x4
Mechanical life expectancy		20x10 ⁶ operations		
Maximum switching rate	Mechanical	3600 operations/hour for monostable version - 900 operations/hour for bistable version		
Degree of protection		IP40		
Dimensions (mm)		132x58x84 ⁽¹⁾	188x58x84 ⁽¹⁾	300x58x84 ⁽¹⁾
Weight (g)		460	770	1150

(1) Output terminals excluded.

Environmental specifications	
Operating temperature	-25 to 55°C
Storage and shipping temperature	-25 to 70°C
Relative humidity	Standard : 75% RH - Tropicalized : 95% RH
Fire behaviour	V0

Standards and reference values	
EN 61810-1, EN 61810-2, EN 61810-7 EN 60695-2-10 EN 50082-2 EN 60529	Electromechanical elementary relays Fire behaviour Electromagnetic compatibility Degree of protection provided by enclosures

Unless otherwise specified, products are designed and manufactured according to the requirements of the European and International standards indicated above. In accordance with EN 61810-1, all items of technical data are referred to ambient temperature 23 °C, atmospheric pressure 96kPa and 50% humidity. Tolerance for coil resistance, nominal electrical input and nominal power is ±7%.

Configurations - Options	
TROPICALIZATION	Surface treatment of the coil with protective coating for use with RH 95%.
GOLD PLATING	Surface treatment of contacts, blades and output terminals with gold-cobalt, thickness ≥2μ. This treatment ensures long-term capacity of the contact to conduct lower currents.
LEVER FOR MANUAL OPERATION	Allows manual operation of the relay, with the cover closed, using a screwdriver.

Ordering scheme							
Product code	Application ⁽¹⁾	Configuration A	Configuration B	Type of power supply	Nominal voltage (V) ⁽²⁾	Finish ⁽³⁾	Keying position code ⁽⁴⁾
RMN	E: Energy F: Railway Fixed Equipment	1: Standard 4: Gold plating	6: 4 SPDT contacts with magnetic arc blow-out 7: 8 SPDT contacts with magnetic arc blow-out 9: 16 SPDT contacts with magnetic arc blow-out	C: Vdc A: Vac 50 Hz H: Vac 60 Hz	012 - 024 - 048 110 - 125 - 132 144 - 220 - 230 380 - 440	T: Tropicalized coil M: Manual operation ⁽⁵⁾	xxx
RMD			1: 4 SPDT contacts 2: 8 SPDT contacts 4: 16 SPDT contacts	C: Vdc	012 - 024 - 048 110 - 125 - 132 144 - 220		

Example	RMN	E	4	7	A	024	M	
	RMNE47-A024/M = ENERGY series monostable relay with coil continuity test, 8 gold-plated contacts, magnetic arc blow-out, 24Vac coil and manual operating lever.							
	RMD	F	1	4	C	110		OVH
	RMDF14-C110-OVH = RAILWAY series bistable relay with coil continuity test, 16 standard contacts, 110Vdc coil and mechanical keying position OVH.							

- (1) ENERGY: all applications except for railway.
RAILWAYS, FIXED EQUIPMENT: application on fixed power systems and electrical railway traction. For list of RFI compliant and type-approved products, consult dedicated catalogue "RAILWAY SERIES – RFI APPROVED".
- (2) Other values on request. Voltages 380V and 440V available as Vac only.
- (3) Optional value. Multiple selection possible (e.g. TM).
- (4) Optional value. Positive mechanical keying is applied according to the manufacturer's product model.
- (5) With manual operation, no optical indicator.

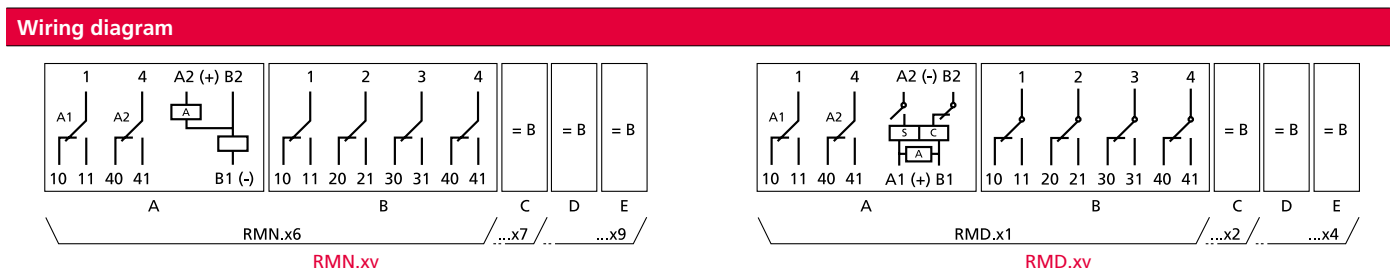

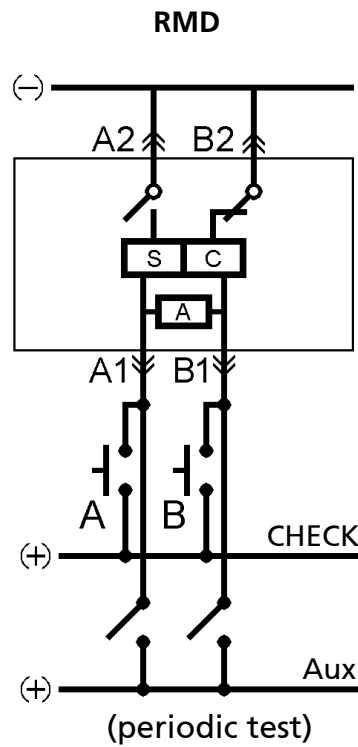
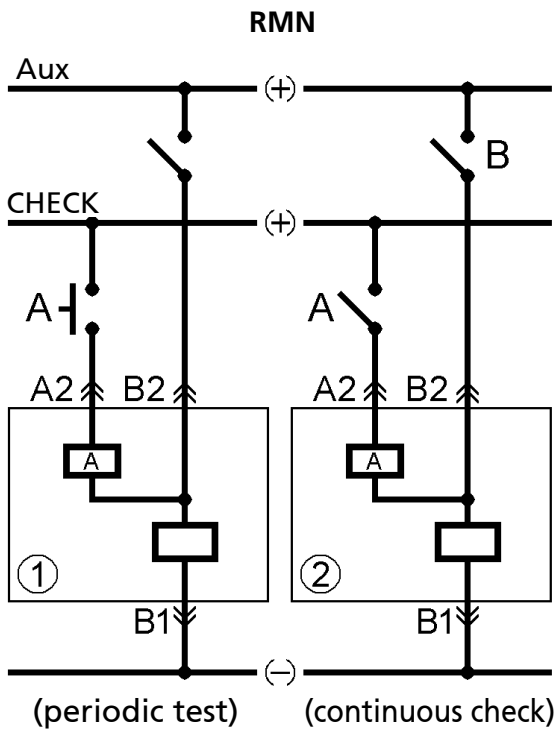

Self-diagnostics function: The main coil is monitored by a monostable relay (A) that indicates when the relay is ready to perform the next operation. Two monitoring methods are possible: 1) Coil tested periodically by pressing button "A". 2) Coil checked continuously by way of contact "A". Following activation of the relay, the reset is accomplished by opening both contacts "A" and "B".

Self-diagnostics function: The latch (C) and unlatch (S) coils are monitored by a monostable relay (A) that indicates when the relay is ready to perform the next operation. Only periodic testing of the coils is possible. Coil (C) is tested by means of button "A", and coil (S) by means of button "B". Note: The contacts of the two buttons "A" and "B" must never be closed simultaneously.

Dimensions

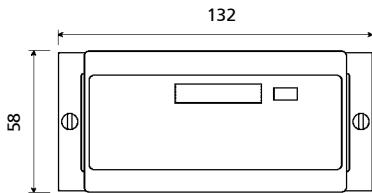

RMN.x6, RMD.x1

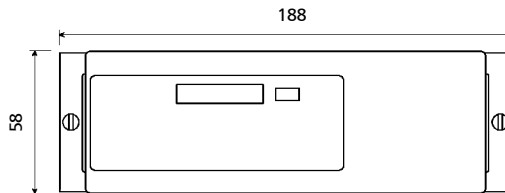

RMN.x7, RMD.x2

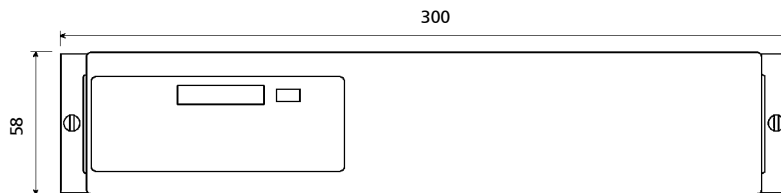
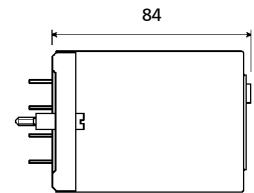

RMN.x9, RMD.x4

Electrical life expectancy (main contacts)

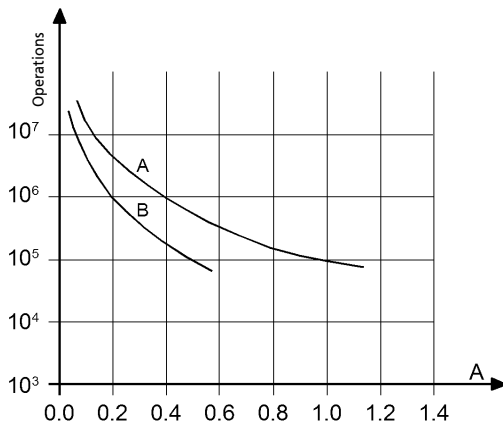

Contact loading: 110Vdc, L/R 40 ms
Curve A: RMN_xy
Curve B: RMD_xy

RMN			
U	I (A)	L/R (ms)	Operations
24Vdc	1	0	7,000,000
24Vdc	1	40	3,000,000
24Vdc	2	40	2,000,000
24Vdc	5	0	3,000,000
24Vdc	5	40	200,000
24Vdc	9	0	800,000
48Vdc	5	20	200,000
110Vdc	0.4	40	1,000,000
110Vdc	1	40	100,000
110Vdc	10	0	100,000
U	I (A)	cosφ	Operations
220Vac	5	0.5	100,000
220Vac	10	1	100,000
230Vac	1	0.7	2,500,000
230Vac	3	0.7	1,200,000

RMD			
U	I (A)	L/R (ms)	Operations
110Vdc	0.5	40	100,000
110Vdc	0.6	10	300,000
120Vdc	0,7	40	100,000
125Vdc	1.2	0	1,000,000
220Vdc	0.1	40	100,000
220Vdc	0.25	10	100,000
U	I (A)	cosφ	Operations
110Vac	1	1	2,000,000
110Vac	1	0.5	1,500,000
110Vac	5	1	1,000,000
110Vac	5	0.5	500,000
220Vac	0.5	1	2,000,000
220Vac	1	0.5	600,000
220Vac	5	1	650,000
220Vac	5	0.5	600,000

Switching frequency: 1,200 operations/hour

Sockets and retaining clips		RMN.x6 - RMD.x1	RMN.x7 - RMD.x2	RMN.x9 - RMD.x4
Type of installation	Type of outputs			
Wall or DIN H35 rail mounting	Screw	PAVM321	PAVM481	PAVM801
Flush mounting	Double faston (4.8 x 0.8 mm)	PRDM321	PRDM481	PRDM801
	Screw	PRVM321	PRVM481	PRVM801

Mounting tips

The preferred mounting position is on the wall, with the relay positioned horizontally in the reading direction on the nameplate.

For correct use of the relays, they should be spaced apart by at least 20 mm in the vertical direction. This is to allow correct upward dissipation of the heat generated by the coil. Set these distances according to the socket used. Distances can be reduced depending on the environmental conditions during operation, and on the relay duty cycle. This precaution does not apply in the case of bistable models, as the automatic coil de-energization function prevents heat being generated.

Retaining clips are not required, as a secure connection is guaranteed by the fixing screws. These same screws also serve to facilitate installation and removal of the relay. To ensure correct use, the screws must be tightened / loosened in alternating sequence, by degrees.

No special maintenance is required.

Condensation can form inside the relay when powered up and the outside ambient temperature is cold; this is quite normal and does not affect the operation of the relay. The plastic materials of the relay do not possess hygroscopic properties.

Notes

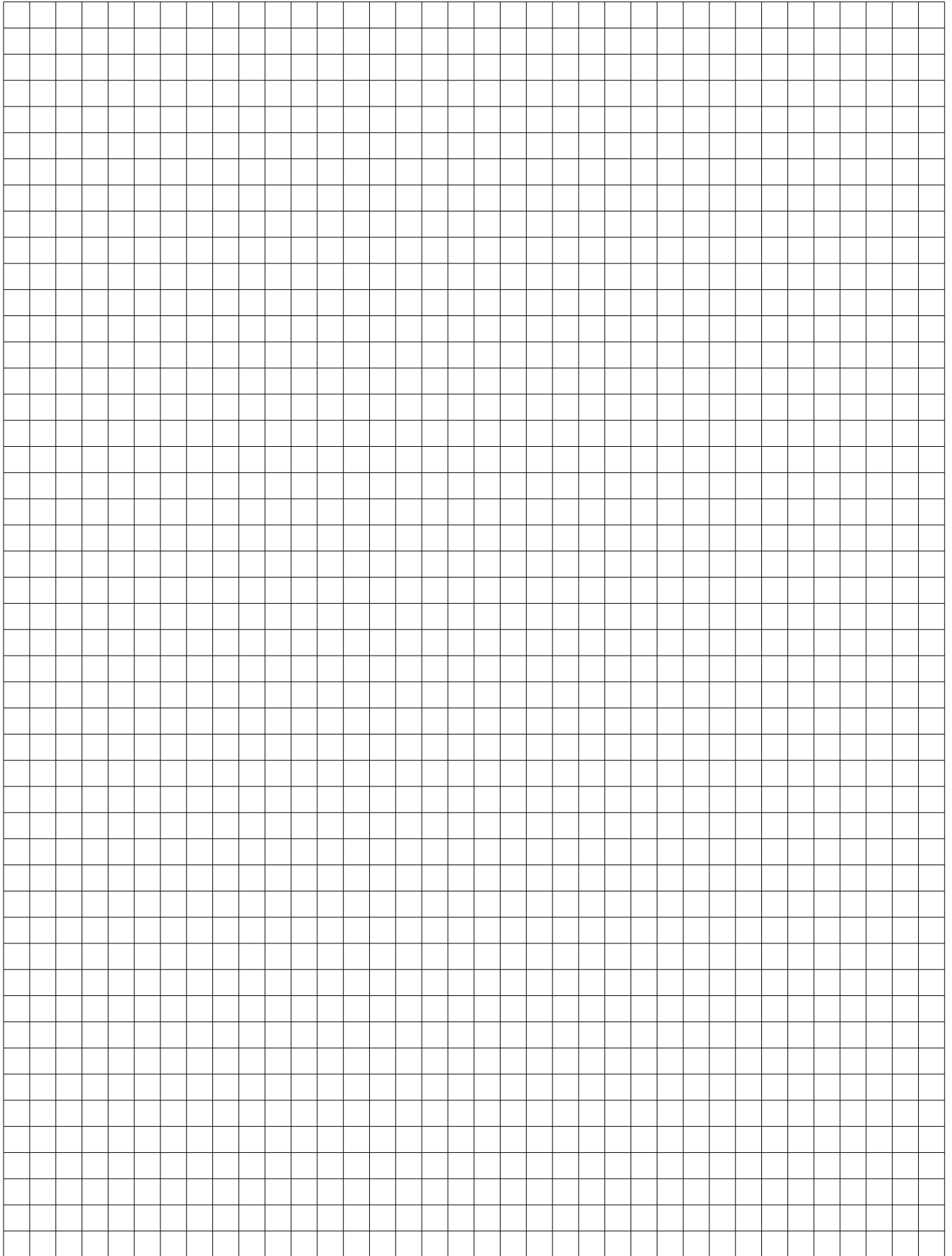

Fast-acting MONOSTABLE relays 2-4-8 contacts

2.08

RQR • RGMV RMMZ • RMMV SERIES-FAST-ACTING



RGMV13



RMMV12

OVERVIEW

- Fast-acting monostable relay
- Solid and rugged construction for heavy or intensive duty
- Very high electrical life expectancy and exceptional endurance
- Self-cleaning knurled contacts
- Direct current operation
- Retaining clip or fixing screws for secure locking of relay to socket
- Transparent cover, pull-out handle or fixing/pulling screws
- Label holder in cover for customer's use
- Positive mechanical keying for relay and socket

APPLICATIONS



Shipbuilding



Petroleum industry



Heavy industry



Power generation



Power distribution



Railway equipment

DESCRIPTION

Fast-acting monostable relays are available in 6 models with different types and numbers of contacts. This family of relays is able to guarantee high speed switching of contacts during pick-up or during drop-out, depending on the model. All models are based on the electromechanical design of the G series, except for the RGRE, which utilizes reed contact technology. These relays can be operated off a d.c. power supply.

In an instantaneous monostable relay, the closure of an NO contact takes normally between 15 and 40 ms, depending on the particular product specifications. By contrast, a fast-acting relay is able to close the contact in a time of between 2.5 and 10 ms. The operating time is measured from the moment when the coil is energized/de-energized until completion of the change in status and stabilization of the contact, including bounces. A 'bounce' is an intermediate position assumed by the contact during the course of stabilization in its final position. Unless specified otherwise, the operating times indicated for AMRA relays include the duration of the bounce. It is advisable to discuss this aspect thoroughly, with the manufacturer, when selecting the component. Knurled contacts ensure not only better self-cleaning characteristics, but also lower ohmic resistance thanks to multiple points of electrical connection, thereby extending the electrical life expectancy of the component.

Typical sectors of use are among the most demanding, such as, for example, electricity generating stations, electrical transformer stations, fixed equipment for railways, or industries using continuous production processes (chemical and petrochemical, rolling mills, cement factories, etc.). The performance and reliability of the product have secured its approval with ENEL and other multi-utilities. Fast-acting relays are often incorporated into circuits of special importance, such as those providing protection and breaker functions on a power line in the event of faults occurring. With this in mind, the operating speed is an essential parameter for electrical system designers. The contacts are connected to multifunction digital protection devices or recording instruments (disturbance recorders).

Like all AMRA relays, models of the fast-acting monostable series are assembled as part of a controlled manufacturing process in which every step of production is verified by the next step in succession. In effect, each relay is calibrated and tested individually, by hand, in such a way as to guarantee top reliability.

Models	Type	Number of contacts	Nominal current	Operating time ⁽¹⁾	
				Pick-up	Drop-out
RGRE12	Monostable	2 SPDT (reed)	2A	≤ 2.5ms	≤ 3ms
RGMV12	Monostable	4 SPDT	10A	≤ 8ms	≤ 45ms
RGMV13	Monostable	4 NC	10A	-	≤ 8ms
RMMV12	Monostable	8 NO	10A	≤ 6ms	-
RMMV13	Monostable	4 NO + 4 NC	10A	≤ 6ms (NO)	≤ 6ms (NC)
RMMZ11	Monostable	8 SPDT	10A	≤ 8 + 5ms	≤ 50ms

(1) Unless specified otherwise, the operating time signifies until stabilization of the contact (including bounces).

FOR CONFIGURATION OF PRODUCT CODE, SEE "ORDERING SCHEME" TABLE

Coil data	RGRE12	RGMV12	RGMV13	RMMV12	RMMV13	RMMZ11
Nominal voltages Un	DC : 24-48-110-125-220 ⁽¹⁾					
Consumption at Un	1W	4W		7W		
Operating range	DC: 80...120% Un		DC: 80...110% Un			
Type of duty	Continuous					
Drop-out voltage ⁽²⁾	DC : > 5% Un					

(1) Other values on request.

(2) Limit value for supply voltage, expressed as % of the nominal value, beneath which the relay is certain to be de-energized.

Contact data	RGRE12	RGMV12	RGMV13	RMMV12	RMMV13	RMMZ11
Number and type	2 SPDT, form C REED	4 SPDT, form C	4 SPST, form C	8 NO	4 NO + 4NC	8 SPDT, form C
Current				10A		
Nominal ⁽¹⁾	2A	20A for 1min - 40A for 1s				
Maximum peak ⁽²⁾	-	150A for 10ms				
Maximum pulse ⁽²⁾	-					
Example of electrical life expectancy ⁽³⁾	0.1A - 110Vdc - L/R=40ms - 10 ⁵ operations 1,800 operations/hour	0.3A - 110Vdc - L/R=40ms - 10 ⁵ operations - 1,800 operations/hour				
Minimum load	200mW (10V, 10mA)	200mW (10V, 10mA)				
Maximum breaking voltage	300 V	350 VDC / 440 VAC				
Contact material	Rh	AgCdO				
Operating time at Un (ms) ⁽⁴⁾						
Pick-up (NO contact closing)	≤ 2.5	≤ 8	-	≤ 6	≤ 6	≤ 8 + 5 ⁽⁵⁾
Drop-out (NC contact closing)	≤ 3	≤ 45	≤ 8	-	≤ 6	≤ 50

(1) On all contacts simultaneously, reduction of 30%.

(2) Maximum peak and pulse currents are those currents that can be handled, for a specified time, by the contact. They do not refer to steady or interrupted currents.

(3) For other examples, see electrical life expectancy curves.

(4) Unless specified otherwise, operating times are understood as comprising stabilization of the contact (inclusive of bounces).

(5) Bounces = 5 ms.

Insulation

Insulation resistance (at 500Vdc) between electrically independent circuits and between these circuits and ground	> 10,000 MΩ
Withstand voltage at industrial frequency between electrically independent circuits and between these circuits and ground between adjacent contacts	2 kV (1 min.) - 2.2kV (1 s) 2 kV (1 min.) - 2.2kV (1 s)
Impulse withstand voltage (1.2/50μs - 0.5J) between electrically independent circuits and between these circuits and ground	5 kV

Mechanical specifications	RGRE12	RGMV12	RGMV13	RMMV12	RMMV13	RMMZ11
Mechanical life expectancy	20x10 ⁶ operations	20x10 ⁶ operations		10x10 ⁶ operations		
Maximum switching rate	Mechanical 3600 man/h	1800 operations/hour				
Degree of protection	IP40					
Dimensions (mm)	45x50x112 ⁽¹⁾	45x50x112 ⁽¹⁾	45x50x86 ⁽¹⁾	132x58x84 ⁽¹⁾		
Weight (g)	190	320	270	530		

(1) Output terminals excluded.

Environmental specifications

Operating temperature	-25 to 55°C
Storage and shipping temperature	-25 to 70°C
Relative humidity	Standard: 75% RH - Tropicalized: 95% RH
Fire behaviour	V0

Standards and reference values

EN 61810-1, EN 61810-2, EN 61810-7 EN 60695-2-10 EN 50082-2 EN 60529	Electromechanical elementary relays Fire behaviour Electromagnetic compatibility Degree of protection provided by enclosures
---	---

Unless otherwise specified, products are designed and manufactured according to the requirements of the European and International standards indicated above.
In accordance with EN 61810-1, all items of technical data are referred to ambient temperature 23 °C, atmospheric pressure 96kPa and 50% humidity.
Tolerance for coil resistance, nominal electrical input and nominal power is $\pm 7\%$.

Configurations - Options

TROPICALIZATION	Surface treatment of the coil with protective coating for use with RH 95%.
LEVER FOR MANUAL OPERATION	Allows manual operation of the relay, with the cover closed, using a screwdriver (RMMZ11 only)

Ordering scheme

Product code	Configuration	Type of power supply	Nominal voltage (V) ⁽¹⁾	Finish ⁽²⁾	Keying position code ⁽³⁾
RGRE	12: 2 SPDT reed contacts	C: Vdc	024 - 048 - 110 125 - 220	T: Tropicalized coil M: Manual operation ⁽⁴⁾	xxx
RGMV	12: 4 SPDT contacts 13: 4 NC contacts				
RMMV	12: 8 NO contacts 13: 4 NO contacts + 4 NC contacts				
RMMZ	11: 8 SPDT contacts				

Example	RGMV	12	C	110		
	RGMV12-C110 = Fast-acting monostable relay with 4 change-over contacts and 110Vdc coil.					
	RMMZ	11	C	048	T	
	RMMZ11-C048 = Fast-acting monostable relay with 8 change-over contacts and 48Vdc tropicalized coil.					

- (1) Other values on request.
(2) Optional value. Multiple selection possible (e.g. TM).
(3) Optional value. Positive mechanical keying is defined according to the manufacturer's model.
(4) RMMZ11 only.

Wiring diagram

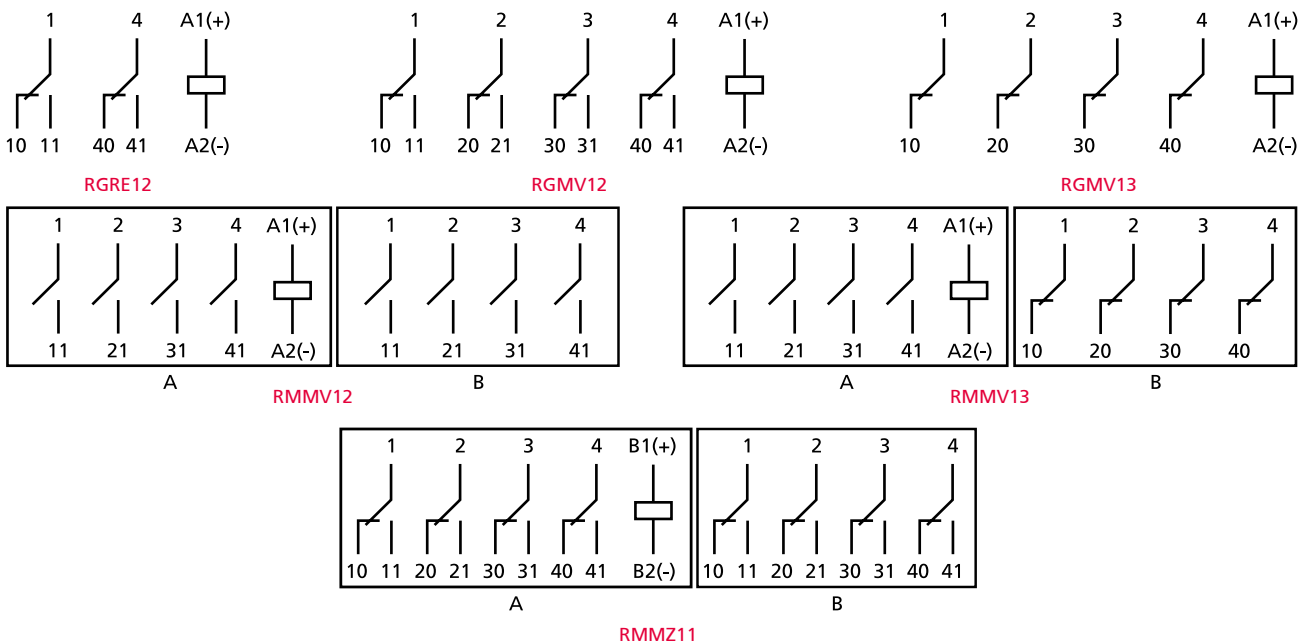

Dimensions

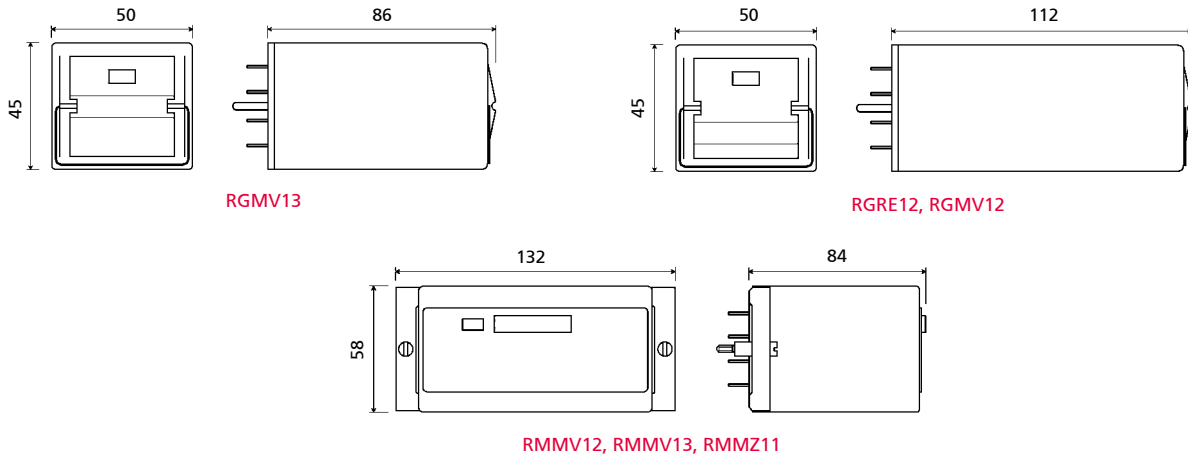

Electrical life expectancy

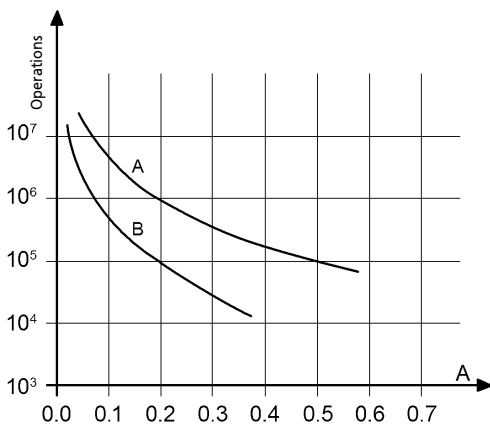

Contact loading: 110Vdc, L/R 40 ms
 Curve A: RMMZ11
 Curve B: RGMV12-13, RMMV12-13

RMMZ11			
U	I (A)	L/R (ms)	Operations
110Vdc	0.5	40	100,000
110Vdc	0.6	10	300,000
125Vdc	0.7	40	100,000
220Vdc	1.2	0	1,000,000
220Vdc	0.1	40	100,000
220Vdc	0.25	10	100,000
U	I (A)	cosφ	Operations
110Vac	1	1	2,000,000
110Vac	1	0.5	1,500,000
110Vac	5	1	1,000,000
110Vac	5	0.5	500,000
220Vac	0.5	1	2,000,000
220Vac	1	0.5	600,000
220Vac	5	1	650,000
220Vac	5	0.5	600,000

Switching frequency: 1,200 operations/hour

RGMV12 - 13			
U	I (A)	L/R (ms)	Operations
110Vdc	0.2	40	500,000
220Vdc	0.2	10	80,000
U	I (A)	cosφ	Operations
110Vac	1	1	1,200,000
110Vac	1	0.5	1,000,000
110Vac	5	1	500,000
110Vac	5	0.5	300,000
220Vac	0.5	1	1,200,000
220Vac	1	0.5	500,000
220Vac	5	1	400,000
220Vac	5	0.5	300,000

Switching frequency: 1,200 operations/h
 (*) = 600 operations/hour

Sockets and retaining clips		RGRE - RGMV12 - RGMV13			RMMV12 - RMMV13 - RMMZ11
Type of installation	Type of outputs	Socket	Clip for RGRE/RGMV12	Clip for RGMV13	Socket
Wall or DIN rail mounting	Screw	PAVG161	VM1222	VM1223	PAVM321
Flush mounting	Double faston (4.8 x 0.8 mm)	PRDG161	VM1222	VM1223	PRDM321
	Screw	PRVG161	VM1222	VM1223	PRVM321

Mounting tips

The preferred mounting position is on the wall, with the relay positioned horizontally in the reading direction on the nameplate. For correct use of the relays, they should be spaced apart by at least 5 mm in the horizontal direction (G series) and 20 mm in the vertical direction (G and M series). This is to allow correct upward dissipation of the heat generated by the coil. Set these distances according to the socket used. Distances can be reduced depending on the environmental conditions during operation, and on the relay duty cycle. For safe and secure operation of G series relays, it is advisable to use retaining clips. Retaining clips are not required for M series relays, as a secure connection is guaranteed by the fixing screws. These same screws also serve to facilitate installation and removal of the relay. To ensure correct use, the screws must be tightened / loosened in alternating sequence, by degrees. No special maintenance is required. Condensation can form inside the relay when powered up and the outside ambient temperature is cold; this is quite normal and does not affect the operation of the relay. The plastic materials of the relay do not possess hygroscopic properties.

Fast-acting BISTABLE relays

3-7 contacts

2.09



RQBZ10



RMBZ30

RQBZ10-T1 • RMBZ30 SERIES – FAST-ACTING

OVERVIEW

- Fast-acting bistable relay
- Solid and rugged construction for heavy or intensive duty
- Very high electrical life expectancy and exceptional endurance
- Self-cleaning knurled contacts
- Direct current operation
- Retaining clip or fixing screws for secure locking of relay to socket
- Transparent cover, pull-out handle or fixing/pulling screws
- Label holder in cover for customer's use
- Positive mechanical keying for relay and socket

APPLICATIONS



Shipbuilding



Petroleum industry



Heavy industry



Power generation



Power distribution



Railway equipment

DESCRIPTION

Fast-acting bistable relays are available in 3 models with 3, 4 and 7 change-over contacts. This family of relays is able to guarantee high speed switching of contacts. Sharing the same basic electromechanical design as relays of the G series, they offer the same specifications and benefits. These relays can be operated off a d.c. power supply.

In an instantaneous bistable relay, the closure of an NO contact takes normally between 30 and 60 ms, depending on the particular product specifications. By contrast, a fast-acting relay is able to close the contact in a time of between 10 and 20 ms. The operating time is measured from the moment when the coil is energized until completion of the change in status and stabilization of the contact, including bounces. A 'bounce' is an intermediate position assumed by the contact during the course of stabilization in its final position. It is advisable to discuss this aspect thoroughly, with the manufacturer, when selecting the component. The contacts used are of a type designed to give good levels of performance both with high and strongly inductive d.c. loads, and with particularly low loads such as interface signals; inclusion of the magnetic arc blow-out function (optional) helps to achieve a considerable increase in breaking capacity. Knurled contacts ensure not only better self-cleaning characteristics, but also lower ohmic resistance thanks to multiple points of electrical connection, thereby extending the electrical life expectancy of the component.

Typical sectors of use are among the most demanding, such as, for example, electricity generating stations, electrical transformer stations, fixed equipment for railways, or industries using continuous production processes (chemical and petrochemical, rolling mills, cement factories, etc.). The performance and reliability of the product have secured its approval with ENEL and other multi-utilities. Fast-acting relays are often incorporated into circuits of key importance, such as those providing protection and breaker functions on a power line in the event of faults occurring. With this in mind, operating speed is an essential parameter for electrical system designers. The contacts are connected to multifunction digital protection devices or recording instruments (disturbance recorders). Like all AMRA relays, models of the fast-acting bistable series are assembled as part of a controlled manufacturing process in which every step of production is verified by the next step in succession. In effect, each relay is calibrated and tested individually, by hand, in such a way as to guarantee top reliability.

Models	Type	Number of contacts	Nominal current	Operating time ⁽¹⁾	
				Pick-up	Drop-out
RGBZ10	Bistable	3	12A	≤ 8 + 4ms	≤ 9 + 25ms
RGBZ11	Bistable	4	12A	≤ 8 + 7ms	≤ 9 + 25ms
RMBZ30	Bistable	7	10A	≤ 10 + 8ms	≤ 10 + 35ms

(1) Operating times are expressed as time of first contact + bounce times.



FOR CONFIGURATION OF PRODUCT CODE, SEE "ORDERING SCHEME" TABLE

Coil data	RGBZ10	RGBZ11	RMBZ30
Nominal voltages Un	DC : 24-48-110-125-220 ⁽¹⁾		
Consumption at Un (DC/AC)	18W ⁽²⁾		36W ⁽²⁾
Operating range	DC: 80...120% Un		
Type of duty	Continuous		

Minimum control pulse 50ms.

(1) Other values on request.

(2) During latch and unlatch. Power consumption is zero on completion of the operating cycle, as the coil de-energizes automatically.

Contact data	RGBZ10	RGBZ11	RMBZ30	
Number and type	3 SPDT, form C	4 SPDT, form C	7 SPDT, form C	
Current	Nominal ⁽¹⁾ 12A		10A	
	Maximum peak ⁽²⁾ 20A for 1min - 40A for 1s			
	Maximum pulse ⁽²⁾ 150A for 10ms			
Example of electrical life expectancy ⁽³⁾	0.5A - 110Vdc - L/R 40ms - 10 ⁵ operations - 1,800 operations/hour			
Minimum load	200mW (10V, 10mA)			
Maximum breaking voltage	350 VDC / 440 VAC			
Contact material	AgCdO			
Operating time at Un (ms) ⁽⁴⁾	RGBZ10	RGBZ11	RMBZ30	
	Pick-up (NO contact closing)	≤ 8 + 4	≤ 8 + 7	≤ 10 + 8
	Drop-out (NC contact closing)	≤ 9 + 25	≤ 9 + 25	≤ 10 + 35

(1) On all contacts simultaneously, reduction of 30%.

(2) Maximum peak and pulse currents are those currents that can be handled, for a specified time, by the contact. They do not refer to steady or interrupted currents.

(3) For other examples, see electrical life expectancy curves.

(4) Operating times are expressed as time of first contact + bounce times.

Insulation	
Insulation resistance (at 500Vdc) between electrically independent circuits and between these circuits and ground between open contact parts	> 10,000 MΩ > 10,000 MΩ
Withstand voltage at industrial frequency between electrically independent circuits and between these circuits and ground between open contact parts between adjacent contacts	2 kV (1 min.) - 2.2kV (1 s) 2 kV (1 min.) - 2.2kV (1 s) 2 kV (1 min.) - 2.2kV (1 s)
Impulse withstand voltage (1.2/50μs - 0.5J) between electrically independent circuits and between these circuits and ground between open contact parts	5 kV 4 kV

Mechanical specifications	RGBZ10	RGBZ11	RMBZ30
Mechanical life expectancy	20x10 ⁶ operations		
Maximum switching rate Mechanical	900 operations/hour		
Degree of protection	IP40		
Dimensions (mm)	45x50x86 ⁽¹⁾	45x50x112 ⁽¹⁾	132x58x86 ⁽¹⁾
Weight (g)	280	370	450

(1) Output terminals excluded.

Environmental specifications

Operating temperature	-25 to 55°C
Storage and shipping temperature	-25 to 70°C
Relative humidity	Standard: 75% RH - Tropicalized: 95% RH
Fire behaviour	V0

Standards and reference values

EN 61810-1, EN 61810-2, EN 61810-7 EN 60695-2-10 EN 50082-2 EN 60529	Electromechanical elementary relays Fire behaviour Electromagnetic compatibility Degree of protection provided by enclosures
---	---

Unless otherwise specified, products are designed and manufactured according to the requirements of the European and International standards indicated above. In accordance with EN 61810-1, all items of technical data are referred to ambient temperature 23 °C, atmospheric pressure 96kPa and 50% humidity. Tolerance for coil resistance, nominal electrical input and nominal power is $\pm 7\%$.

Configurations - Options

TROPICALIZATION	Surface treatment of the coil with protective coating for use with RH 95%.
LEVER FOR MANUAL OPERATION	Allows manual operation of the relay, with the cover closed, using a screwdriver (except RGBZ11).

Ordering scheme

Product code	Configuration	Type of power supply	Nominal voltage (V) ⁽¹⁾	Finish ⁽²⁾	Keying position code ⁽³⁾
RGBZ	10: 3 SPDT contacts 11: 4 SPDT contacts	C: Vdc	024 - 048 - 110 125 - 132 - 144 220	T: Tropicalized coil M: Manual operation ⁽⁴⁾	xxx
RMBZ	30: 7 SPDT contacts				

Example	RGBZ	10	C	110		
	RGBZ10-C110 = Fast-acting bistable relay with 3 change-over contacts and 110Vdc coil.					
	RMBZ	30	C	048	T	
	RMBZ30-C048/T = Fast-acting bistable relay with 7 change-over contacts and 48Vdc tropicalized coil.					

- (1) Other values on request.
 (2) Optional value. Multiple selection possible (e.g. TM).
 (3) Optional value. Positive mechanical keying is defined according to the manufacturer's model.
 (4) RMBZ30 only.

Wiring diagram

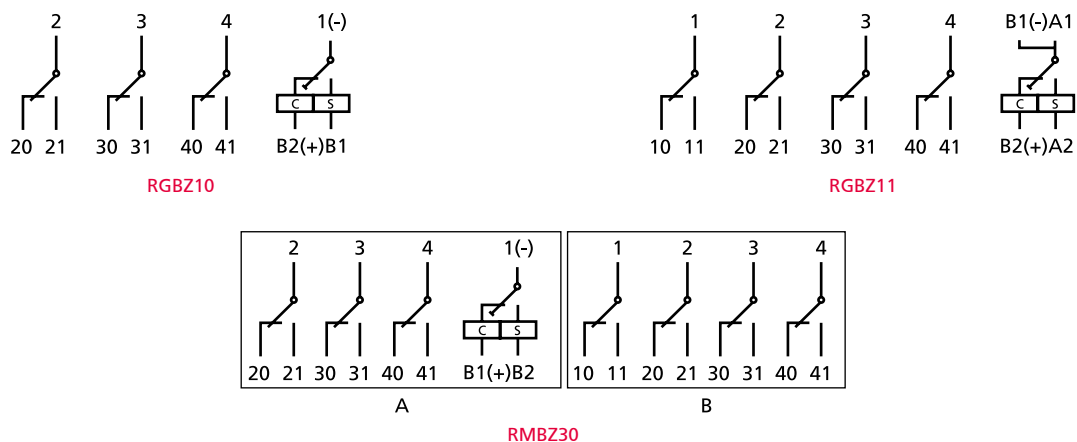

Dimensions

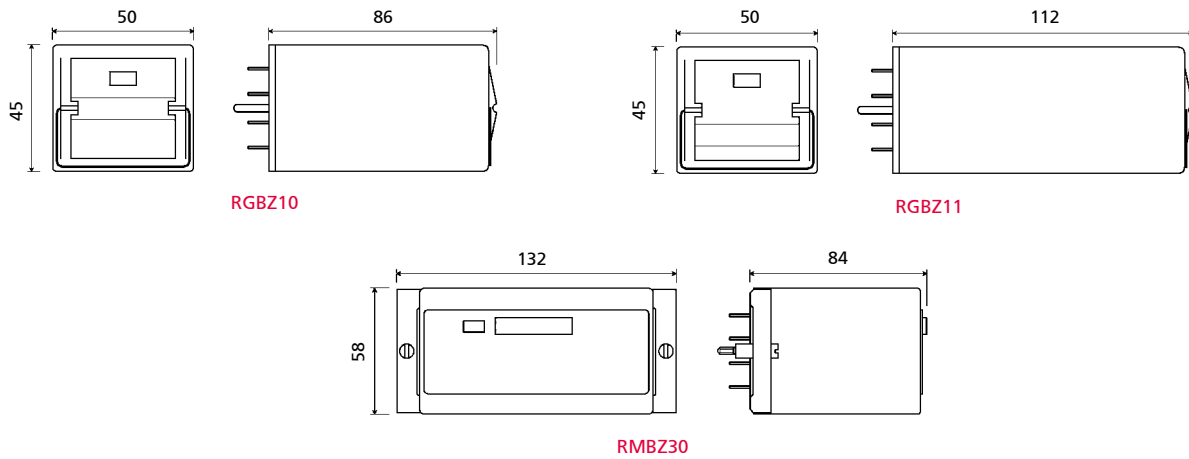

Electrical life expectancy

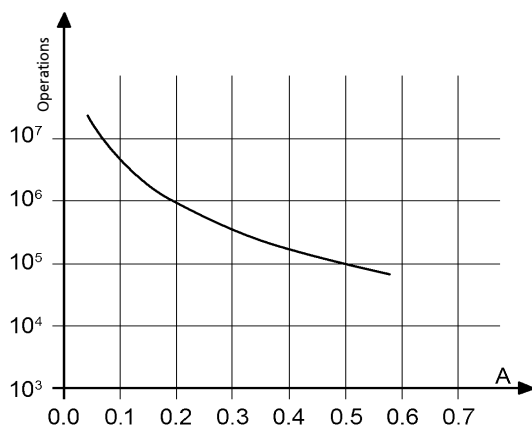

Contact loading: 110Vdc, L/R 40 ms

U	I (A)	L/R (ms)	Operations
110Vdc	0.5	40	100,000
110Vdc	0.6	10	300,000
120Vdc	0.7	40	100,000
125Vdc	1.2	0	1,000,000
220Vdc	0.1	40	100,000
220Vdc	0.25	10	100,000
U	I (A)	cosφ	Operations
110Vac	1	1	2,000,000
110Vac	1	0.5	1,500,000
110Vac	5	1	1,000,000
110Vac	5	0.5	500,000
220Vac	0.5	1	2,000,000
220Vac	1	0.5	600,000
220Vac	5	1	650,000
220Vac	5	0.5	600,000

Switching frequency: 1,200 operations/hour

Sockets and retaining clips		RGBZ10 - RGBZ11			RMBZ30
Type of installation	Type of outputs	Socket	Clip for RGBZ10	Clip for RGBZ11	Socket
Wall or DIN rail mounting	Screw	PAVG161	VM1222	VM1223	PAVM321
Flush mounting	Double faston (4.8 x 0.8 mm)	PRDG161	VM1222	VM1223	PRDM321
	Screw	PRVG161	VM1222	VM1223	PRVM321

Mounting tips

The preferred mounting position is on the wall, with the relay positioned horizontally in the reading direction on the nameplate. For safe and secure operation of G series relays, it is advisable to use retaining clips. Retaining clips are not required for M series relays, as a secure connection is guaranteed by the fixing screws. These same screws also serve to facilitate installation and removal of the relay. To ensure correct use, the screws must be tightened / loosened in alternating sequence, by degrees. No special maintenance is required.

Condensation can form inside the relay when powered up and the outside ambient temperature is cold; this is quite normal and does not affect the operation of the relay. The plastic materials of the relay do not possess hygroscopic properties.

Monostable multiscale timer relay - 4 contacts

2.10

RDT SERIES

OVERVIEW

- Plug-in relay with time delay on pick-up or on drop-out
- Only model programmable on pick-up or on drop-out
- High performance, compact dimensions
- Wide time setting range from 0.1s to more than 16 hours, great accuracy over the entire adjustment range
- Led optical indicators monitoring power supply and timer status
- Magnetic arc blow-out for higher breaking capacity
- Self-cleaning knurled contacts
- Relay coupled automatically to socket, with no need for a retaining clip
- Operation with d.c. and/or a.c. power supply
- Wide variety of configurations and customizations
- Transparent cover, pull-out handle
- Label holder in cover for customer's use
- Positive mechanical keying for relay and socket



RDT

APPLICATIONS



Shipbuilding



Petroleum industry



Heavy industry



Power generation



Power distribution



Railway equipment

DESCRIPTION

The RDT series is a range of relays with electronic time delay on pick-up or on drop-out, consisting of 6 models with 4 change-over contacts, from 10 A (nominal). RDT relays are created by assembling electromechanical units of the RDM series with a digital electronic circuit. The electronic circuit is assembled using a small number of selected professional components for top reliability. The electronics are immune to strong EMC interference, typical of high voltage electricity distribution stations.

These monostable relays are capable of switching times ranging from 0.1 second to over 16 hours, providing extreme accuracy over the entire setting range. This is made possible by the fact that the relay offers intermediate scales, which the user can select by means of rotary switches positioned on the front of the enclosure.

The contacts used are of a type designed to give good levels of performance both with high and strongly inductive d.c. loads, and with particularly low loads such as interface signals; inclusion of the magnetic arc blow-out function, when installed, helps to achieve a considerable increase in breaking capacity. Knurled contacts ensure not only better self-cleaning characteristics, but also lower ohmic resistance thanks to multiple points of electrical connection, thereby extending the electrical life expectancy of the component.

The timing function can be utilized in two modes: "on pick-up" or "on drop-out"; models are available with 4 timer contacts or with 2 timer contacts and 2 instantaneous contacts.

The construction of the relays and their simplified mechanical design combine to ensure these products offer high reliability in operation, as proven by their use for over 40 years in electrical energy transport and distribution systems, and fixed equipment used in the railway sector. Typical sectors of use are among the most demanding, such as, for example, electricity generating stations, electrical transformer stations, fixed equipment for railways, or industries using continuous production processes (chemical and petrochemical, rolling mills, cement factories, etc.).

Like all AMRA relays, models of the RDT series are assembled as part of a controlled manufacturing process in which every step of production is verified by the next step in succession. In effect, each relay is calibrated and tested individually, by hand, in such a way as to guarantee top reliability.

Models	Number of contacts		Magnetic arc blow-out	Separate control voltage	Function
	Instantaneous	Time-delayed			
RDT.x1c	-	4			Pick-up / Drop-out
RDT.x7c	-	4	•		Pick-up / Drop-out
RDT.x2c	2	2			Pick-up / Drop-out
RDT.x8c	2	2	•		Pick-up / Drop-out
RDT.x4c	-	4		•	Pick-up / Drop-out
RDT.x9c	-	4	•	•	Pick-up / Drop-out

FOR CONFIGURATION OF PRODUCT CODE, SEE "ORDERING SCHEME" TABLE

Coil data	RDT.x1c-x4c-x7c-x9c	RDT.x2c-x8c
Nominal voltages Un	AC / DC : 12-24-48-110-125-132-144-220 ⁽¹⁾	
Consumption at Un (DC/AC)	3.5W	4.5W
Operating range	80...120% Un	
Type of duty	Continuous	
Drop-out voltage ⁽²⁾	> 5% Un	

(1) Other values on request.

(2) Limit value for supply voltage, expressed as % of the nominal value, beneath which the relay is certain to be de-energized.

Contact data		
Number and type	4 SPDT, form C	
Current	Nominal ⁽¹⁾	10A
	Maximum peak ⁽²⁾	13A for 1min - 20A for 1s
	Maximum pulse ⁽²⁾	100A for 10ms
Example of electrical life expectancy ⁽³⁾	RDT.x1c-x2c-x4c : 0.2A - 110Vdc - L/R = 40ms - 10 ⁵ operations - 1800 operations/hour RDT.x7c-x8c-x9c : 0.5A - 110Vdc - L/R = 40ms - 10 ⁵ operations - 1800 operations/hour	
Minimum load	Standard contacts	200mW (10V, 10mA)
	Gold-plated contacts	50mW (5V, 5mA)
Maximum breaking voltage	250 Vdc / 300 Vac	
Contact material	AgCdO (moving contacts) - AgNi (fixed contacts)	
Operating time at Un (ms) ^{(4) (5)}	DC - AC	
Pick-up (NC contact opening)	≤ 10 - ≤ 10	
Pick-up (NO contact closing)	≤ 19 - ≤ 18	
Drop-out (NO contact opening)	≤ 4 - ≤ 8	
Drop-out (NC contact closing)	≤ 16 - ≤ 19	

(1) On all contacts simultaneously, reduction of 30%.

(2) Maximum peak and pulse currents are those currents that can be handled, for a specified time, by the contact. They do not refer to steady or interrupted currents.

(3) For other examples, see electrical life expectancy curves.

(4) Unless specified otherwise, the operating time signifies until stabilization of the contact (including bounces).

(5) Times for instantaneous contacts, if installed.

Insulation		
Insulation resistance (at 500Vdc)	between electrically independent circuits and between these circuits and ground	> 10,000 MΩ
	between open contact parts	> 10,000 MΩ
Withstand voltage at industrial frequency	between electrically independent circuits and between these circuits and ground	2 kV (1 min.) - 2.2kV (1 s)
	between open contact parts	2 kV (1 min.) - 2.2kV (1 s)
	between adjacent contacts	2 kV (1 min.) - 2.2kV (1 s)
Impulse withstand voltage (1.2/50μs - 0.5J)	between electrically independent circuits and between these circuits and ground	5 kV
	between open contact parts	3 kV

Mechanical specifications		
Mechanical life expectancy	Mechanical	20x10 ⁶ operations
Maximum switching rate	Mechanical	3600 operations/hour
Degree of protection		IP40
Dimensions (mm)		40x40x82 ⁽¹⁾
Weight (g)		150

(1) Output terminals excluded

Environmental specifications

Operating temperature	-25 to +55°C
Storage and shipping temperature	-25 to +70°C
Relative humidity	Standard : 75% RH - Tropicalized : 95% RH
Fire behaviour	V0

Standards and reference values

EN 61810-1, EN 61810-2, EN 61810-7 EN61812-1 EN 60695-2-10 EN 50082-2 EN 60529	Electromechanical elementary relays Timer relays Fire behaviour Electromagnetic compatibility Degree of protection provided by enclosures
--	---

Unless otherwise specified, products are designed and manufactured according to the requirements of the European and International standards indicated above.
In accordance with EN 61810-1, all items of technical data are referred to ambient temperature 23 °C, atmospheric pressure 96kPa and 50% humidity.
Tolerance for coil resistance, nominal electrical input and nominal power is $\pm 7\%$.

Configurations - Options

TROPICALIZATION	Surface treatment of coil with protective coating for use in conditions of RH 95%.
GOLD PLATING	Surface treatment of contacts, blades and output terminals with gold-cobalt alloy, thickness $\geq 2\mu$. This treatment ensures long-term capacity of the contact to conduct lower currents.

Ordering scheme

Product code	Application ⁽¹⁾	Configuration A	Configuration B	Type of power supply	Nominal voltage (V) ⁽²⁾	Finish ⁽³⁾	Keying position code ⁽⁴⁾
RDT	E: Energy F: Railway Fixed equipment	1: Standard 4: Gold plating	1C: 4 SPDT timer contacts 2C: 2 SPDT timer contacts + 2 SPDT instantaneous contacts 4C: 4 SPDT timer contacts with control voltage 7C: 4 SPDT timer contacts with magnetic arc blow-out 8C: 2 SPDT timer contacts + 2 SPDT instantaneous contacts with magnetic arc blow-out 9C: 4 SPDT timer contacts with control voltage and magnetic arc blow-out	C: Vdc A: Vac 50 Hz H: Vac 60 Hz T ⁽⁵⁾ : Vdc + Vac 50 Hz	012 - 024 - 048 110 - 125 - 132 144 - 220	T: Tropicalized coil	xx

Example	RDT	E	1	7C	T	110	T	ZH
	RDTE17C-T110/T-ZH = ENERGY series relay with 4 SPDT timer contacts, magnetic arc blow-out, 110Vdc or Vac (50Hz) tropicalized coil, and keying position ZH							
	RDT	F	4	2C	C	024		XG
RDTF42c-C024 = RAILWAY series relay, fixed equipment, with 2 SPDT timer contacts and 2 instantaneous, gold-plated contacts, and 24Vdc coil								

(1) ENERGY: all applications except for railway.

RAILWAYS, FIXED EQUIPMENT: application on fixed power systems and electrical railway traction. For list of RFI compliant and type-approved products, consult dedicated catalogue "RAILWAY SERIES - RFI APPROVED".

Also available is the STATIONS series, with ENEL approved material meeting LV15/LV16 specifications. For list of ENEL compliant and type-approved products, consult dedicated catalogue "STATIONS SERIES - LV15-LV16-LV20".

(2) Other values on request.

(3) Optional value.

(4) Optional value. The positive mechanical keying is applied according to the manufacturer's model.

(5) AC+DC power input possible only with models RDT.x1C and RDT.x7C

Wiring diagram

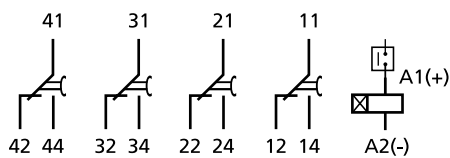

Pick-up diagram RDT.x1c-x7c

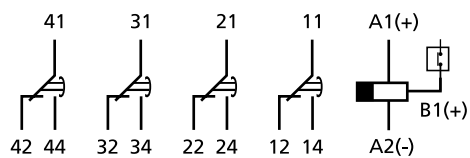

Drop-out diagram RDT.x1c-x7c

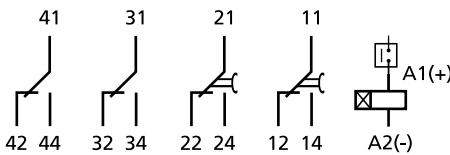

Pick-up diagram RDT.x2c-x8c

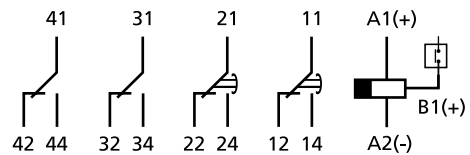

Drop-out diagram RDT.x2c-x8c

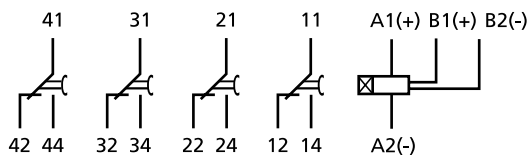

Pick-up diagram RDT.x4c-x9c

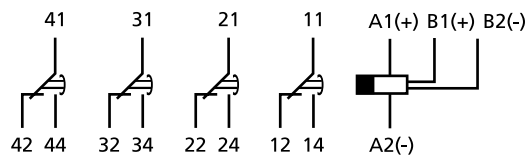

Drop-out diagram RDT.x4c-x9c

Functional diagram

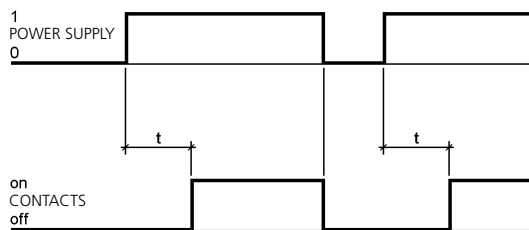

Pick-up delay RDT.x1c-x7c

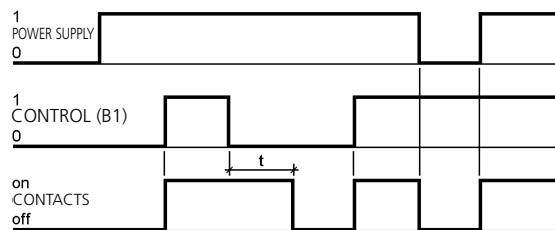

Drop-out delay RDT.x1c-x7c

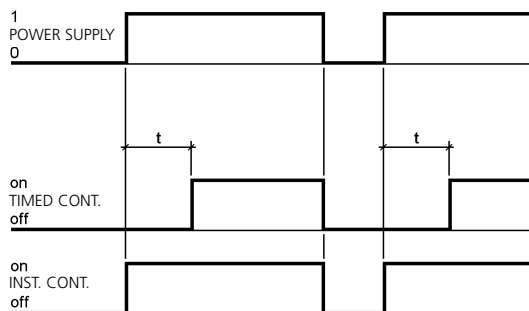

Pick-up delay RDT.x2c-x8c

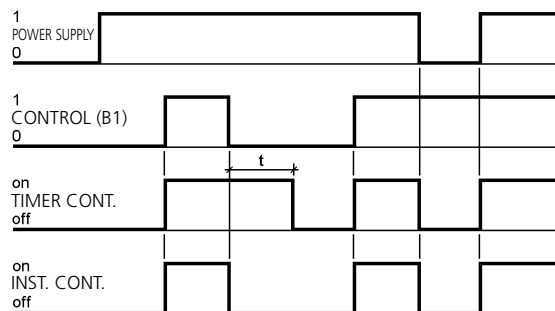

Drop-out delay RDT.x2c-x8c

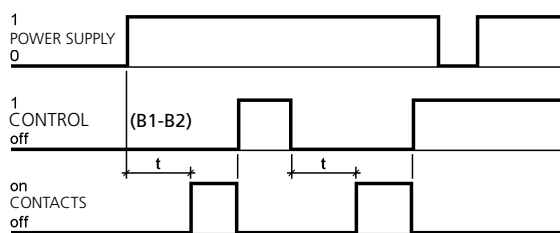

Pick-up delay RDT.x4c-x9c

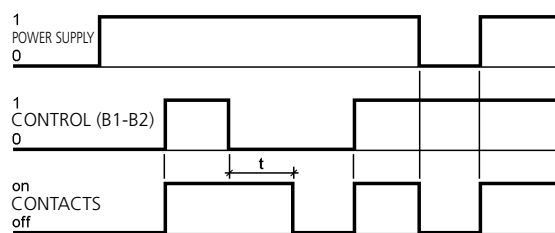

Drop-out delay RDT.x4c-x9c



Time setting	By means of DIP switches and selectors
Time setting range	100ms...990min
Intermediate scales	6 (0.99 - 9.9 - 99 - 990 seconds / 99 - 990 minutes)
Resolution of switching time setting	1/100 of selected scale
Operating accuracy (0.8...1.1 Un, t=20°C) ⁽¹⁾	± 3 % at low end of scale - ±0.5 % at high end of scale
Accuracy, repeatability	± 2 %
Reset	< 200ms
Insensitivity to voltage drops	< 100 ms
Indication	Red led = presence of power supply Green led = status of relay outputs (lights up with relay energized)

(1) Additional error for drop-out versions: 100 ms

The timer function and the switching time are set by way of a single 4-bit DIP switch and two rotary selectors adjustable through 10 positions, located on the front of the relay (see "FRONT"). These are accessible by opening the flap on the cover of the relay. The time delay function can be associated either with pick-up or with drop-out; settings range from 100 ms up to 990 minutes.

Selection of function: select the OFF or ON position at switch no. 4. OFF: Pick-up - ON: Drop-out.

Selection of operating time: the unit of measure is selected with switches no. 1-2-3, and the desired delay interval by means of the 2 rotary selectors.

To set the switching time correctly, the first step required is to identify and select one of the 6 intermediate scales indicated in table 1.

The intermediate scale should be the next higher numerically than the value of the required switching time.

E.g. Switching time: 1'14" (74 seconds), Intermediate scale setting: 99 seconds.

This done, proceed to set the desired value with the two rotary selectors. E.g. 74 seconds, select 7 on the "TENS" selector and 4 on the "UNITS" selector.

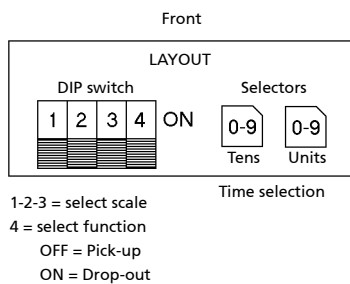

Scales / Setting range			Switch position		
Min	Max	Unit of measure	1	2	3
1	99	Hundredths (0.01s)	OFF	ON	OFF
1	99	Tenths (0.1s)	OFF	ON	ON
1	99	Seconds	ON	OFF	OFF
1	99	Seconds x 10	ON	OFF	ON
1	99	Minutes	ON	ON	OFF
1	99	Minutes x 10	ON	ON	ON

Table 1

Dimensions

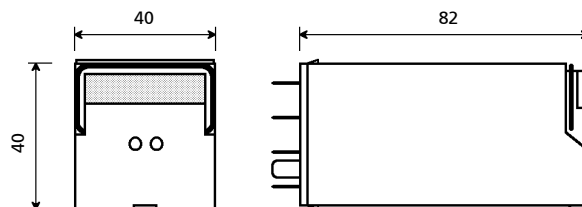

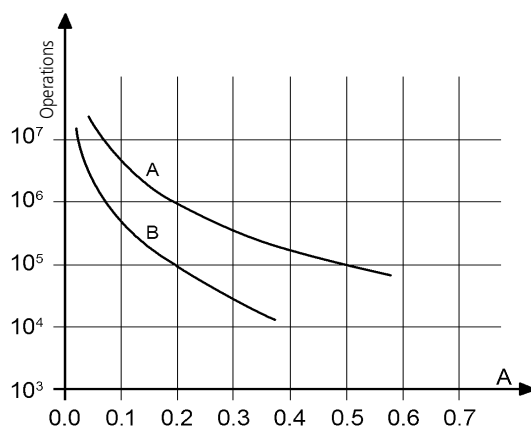

Contact loading: 110Vdc, L/R 40 ms
 Curve A: RDT_x7-x8-x9
 Curve B: RDT_x1-x2-x4

RDT_x1-x2-x4			
U	I (A)	L/R (ms)	Operations
110Vdc	0.2	40	500,000
220Vdc	0.2	10	80,000
U	I (A)	cosφ	Operations
110Vac	1	1	1,200,000
110Vac	1	0.5	1,000,000
110Vac	5	1	500,000
110Vac	5	0.5	300,000
220Vac	0.5	1	1,200,000
220Vac	1	0.5	500,000
220Vac	5	1	400,000
220Vac	5	0.5	300,000

Switching frequency: 1,200 operations/hour
 (*) 600 operations/hour

RDT_x7-x8-x9			
U	I (A)	L/R (ms)	Operations
110Vdc	0.2	40	1,000,000
110Vdc	0.5	40	150,000
110Vdc	0.6	10	300,000
110Vdc	1	10	100,000 (*)
220Vdc	0.2	10	100,000
U	I (A)	cosφ	Operations
110Vac	1	1	2,000,000
110Vac	1	0.5	1,500,000
110Vac	5	1	950,000
110Vac	5	0.5	500,000
220Vac	0.5	1	2,000,000
220Vac	1	0.5	800,000
220Vac	5	1	600,000
220Vac	5	0.5	500,000

Switching frequency: 1,200 operations/hour

Sockets and retaining clips

Type of installation	Type of outputs	Model	Retaining clip
Wall or DIN H35 rail mounting	Screw	PAVD161	VM1823
Flush mounting	Screw	PRVD161	-
PCB-mount	Solder	PRCD161	-

Mounting tips

The preferred mounting position is on the wall, with the relay positioned horizontally in the reading direction on the nameplate. For correct use of the relays, they should be spaced apart by at least 5 mm in the horizontal direction and 20 mm in the vertical direction. This is to allow correct upward dissipation of the heat generated by the coil. Set these distances according to the socket used. Distances can be reduced depending on the environmental application conditions and on the relay duty cycle. No special maintenance is required. Condensation can form inside the relay when powered up and the outside ambient temperature is cold; this is quite normal and does not affect the operation of the relay. The plastic materials of the relay do not possess hygroscopic properties.

RDL • RQL SERIES

OVERVIEW

- Plug-in oscillating monostable relay
- High performance, compact dimensions
- Solid and rugged construction for heavy or intensive duty
- Very high electrical life expectancy and exceptional endurance
- Magnetic arc blow-out for higher breaking capacity
- Self-cleaning knurled contacts
- Operation using d.c. or a.c. power supply with a single product
- Retaining clip for secure locking of relay on socket
- Label holder in cover for customer's use
- Positive mechanical keying for relay and socket



RDLE



RGLE

APPLICATIONS



Shipbuilding



Petroleum industry



Heavy industry



Power generation



Power distribution



Railway equipment

DESCRIPTION

The RDL and RGL series are made up of 2 relay models with 2 change-over contacts, having a flasher logic function. This function is called for generally when the application requires a cyclical change in status of the output contacts with the coil constantly under power. RDL and RGL relays are derived from the RDM and RGM series, respectively, and have the same electromechanical specifications. The logic function is provided through the adoption of an electronic circuit comprising analogue components, carefully selected to the end of achieving a notably fast switching frequency in combination with high immunity to EMC interference. The switching frequency is non-adjustable, factory set at between 55 and 90 changes per minute, depending on the environmental operating specifications.

The contacts used are of a type designed to give good levels of performance both with high and strongly inductive d.c. loads, and with particularly low loads such as interface signals; inclusion of the magnetic arc blow-out function (optional) helps to achieve a considerable increase in breaking capacity. Knurled contacts ensure not only better self-cleaning characteristics, but also lower ohmic resistance thanks to multiple points of electrical connection, thereby extending the electrical life expectancy of the component.

The construction of the relays and their simplified mechanical design combine to ensure these products offer high reliability in operation, as proven by their use for over 40 years in electrical energy transport and distribution systems, and fixed equipment used in the railway sector.

Typical sectors of use are among the most demanding, such as, for example, electricity generating stations, electrical transformer stations, fixed equipment for railways, or industries using continuous production processes (chemical and petrochemical, rolling mills, cement factories, etc.)

Like all AMRA relays, models of the RDL and RGL series are assembled as part of a controlled manufacturing process in which every step of production is verified by the next step in succession. In effect, each relay is calibrated and tested individually, by hand, in such a way as to guarantee top reliability.

Models	Number of contacts	Capacity of contacts	Magnetic arc blow-out
RDLE13	2	10A	•
RGLE13	2	12A	

FOR CONFIGURATION OF PRODUCT CODE, SEE "ORDERING SCHEME" TABLE

Coil data	RDL_13	RGL_13
Nominal voltages Un	AC / DC : 12-24-48-110-125-220 ⁽¹⁾	
Consumption at Un (DC/AC)	3.5W	5W
Operating range	DC: 80...120% Un	
Type of duty	Continuous	
Drop-out voltage ⁽²⁾	> 5% Un	

(1) Other values on request.

(2) Limit value for supply voltage, expressed as % of the nominal value, beneath which the relay is certain to be de-energized.

Contact data	RDL_13	RGL_13
Number and type	2 SPDT, form C	
Current	Nominal	10A
	Maximum peak ⁽¹⁾	13A for 1min - 20A for 1s
	Maximum pulse ⁽¹⁾	100A for 10ms
Example of electrical life expectancy	0.2A - 110Vdc - L/R 40ms - 1.5x10 ⁵ operations - 1,800 operations/hour	
Minimum load	Standard contacts	200mW (10V, 10mA)
	Gold-plated contacts	50mW (5V, 5mA)
Maximum breaking voltage	250 Vdc / 300 Vac	350 Vdc / 440 Vac
Contact material	AgCdO (moving contacts) - AgNi (fixed contacts)	

(1) Maximum peak and pulse currents are those currents that can be handled, for a specified time, by the contact. They do not refer to steady or interrupted currents.

Insulation	
Insulation resistance (at 500Vdc) between electrically independent circuits and between these circuits and ground between open contact parts	> 10,000 MΩ > 10,000 MΩ
Withstand voltage at industrial frequency between electrically independent circuits and between these circuits and ground between open contact parts between adjacent contacts	2 kV (1 min.) - 2.2kV (1 s) 2 kV (1 min.) - 2.2kV (1 s) 2 kV (1 min.) - 2.2kV (1 s)
Impulse withstand voltage (1.2/50μs - 0.5J) between electrically independent circuits and between these circuits and ground between open contact parts	5 kV 3 kV

Mechanical specifications	RDL_13	RGL_13
Mechanical life expectancy	20x10 ⁶ operations	
Maximum switching rate	3600 operations/hour	
Degree of protection	IP40	
Dimensions (mm)	40x40x75 ⁽¹⁾	45x50x112 ⁽¹⁾
Weight (g)	130	310

(1) Output terminals excluded.

Environmental specifications	
Operating temperature	-25 to 55°C
Storage and shipping temperature	-25 to 70°C
Relative humidity	Standard: 75% RH - Tropicalized: 95% RH
Fire behaviour	V0

Standards and reference values

EN 61810-1, EN 61810-2, EN 61810-7
 EN 60695-2-10
 EN 50082-2
 EN 60529

Electromechanical elementary relays
 Fire behaviour
 Electromagnetic compatibility
 Degree of protection provided by enclosures

Unless otherwise specified, products are designed and manufactured according to the requirements of the European and International standards indicated above. In accordance with EN 61810-1, all items of technical data are referred to ambient temperature 23 °C, atmospheric pressure 96kPa and 50% humidity. Tolerance for coil resistance, nominal electrical input and nominal power is $\pm 7\%$.

Configurations - Options

TROPICALIZATION	Surface treatment of the coil with protective coating for use with RH 95%.
GOLD PLATING	Surface treatment of contacts, blades and output terminals with gold-cobalt alloy, thickness $\geq 2\mu$. This treatment ensures long-term capacity of the contact to conduct lower currents.

Ordering scheme

Product code	Application ⁽¹⁾	Configuration A	Configuration B	Type of power supply	Nominal voltage (V) ⁽²⁾	Finish ⁽³⁾	Keying position code ⁽⁴⁾
RDL	E: Energy	1: Standard	3: 2 SPDT contacts	T: Vdc/Vac	012 - 024 - 048	T: Tropicalized coil	xx
RGL	F: Railway Fixed Equipment	4: Gold plating			110 - 120 - 220		

RDL	E	4	3	T	048	T	
RDLE43-T048/T = ENERGY series relay with 2 SPDT gold-plated contacts, magnetic arc blow-out and 48V 50Hz tropicalized coil.							
RGL	F	1	3	T	110		
RGLF13-T110 = RGL RAILWAY series relay, fixed equipment, with 2 SPDT contacts, magnetic arc blow-out and 110Vac/dc coil.							

(1) ENERGY: all applications except for railway.

RAILWAYS, FIXED EQUIPMENT: application on fixed power systems and electrical railway traction. For list of RFI compliant and type-approved products, consult dedicated catalogue "RAILWAY SERIES – RFI APPROVED".

Also available is the STATIONS series, with ENEL approved material meeting LV15/LV16 specifications. For list of ENEL compliant and type-approved products, consult dedicated catalogue "STATIONS SERIES – LV15-LV16-LV20".

(2) Other values on request.

(3) Optional value.

(4) Optional value. Positive mechanical keying is applied according to the manufacturer's model.

Wiring diagram

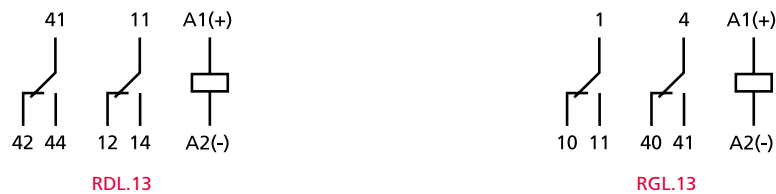

Functional diagram

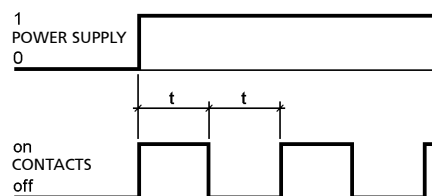

RDL.13, RGL.13

Time delay

Pulses per minute	55 - 90
Operating cycle	50%
Pulse length	Fixed duration

Dimensions

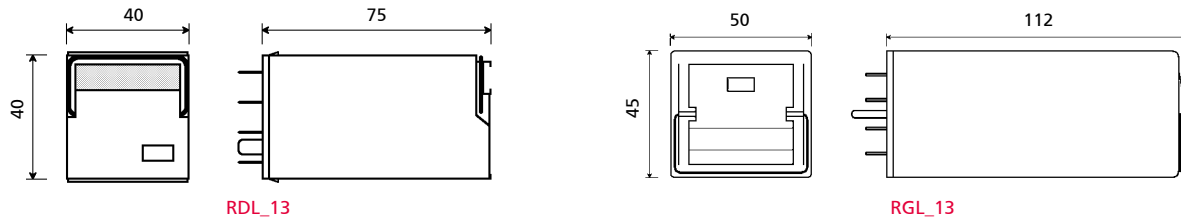

RDL_13

RGL_13

Sockets and retaining clips		RDL_13		RGL_13	
Type of installation	Type of outputs	Socket	Clip	Socket	Clip
Wall or DIN H35 rail mounting	Screw	PAVD161	VM1822	PAVG161	VM1222
Flush mounting	Double faston (4.8 x 0.8 mm)	-	-	PRDG161	VM1222
	Screw	PRVD161	-	PRVG161	VM1222
PCB-mount		PRCD161	-	-	-

Mounting tips

The preferred mounting position is on the wall, with the relay positioned horizontally in the reading direction on the nameplate.

For correct use of the relays, they should be spaced apart by at least 5 mm in the horizontal direction and 20 mm in the vertical direction. This is to allow correct upward dissipation of the heat generated by the coil. Set these distances according to the socket used. Distances can be reduced depending on the environmental application conditions and on the relay duty cycle.

No special maintenance is required.

Condensation can form inside the relay when powered up and the outside ambient temperature is cold; this is quite normal and does not affect the operation of the relay. The plastic materials of the relay do not possess hygroscopic properties.

Relay with time delay on drop-out, capacitor type

2.12

RDTE15-16 RGTO SERIES



RDTE161



RGTO233

OVERVIEW

- Plug-in relay with time delay on drop-out
- Time settings up to 60s, no auxiliary power supply required
- Self-cleaning knurled contacts
- High performance, compact dimensions
- Solid and rugged construction for heavy or intensive duty
- Very high electrical life expectancy and exceptional endurance
- Wide variety of configurations and customizations
- Retaining clip for secure locking of relay on socket
- Transparent cover, pull-out handle
- Positive mechanical keying for relay and socket

APPLICATIONS



Shipbuilding



Petroleum industry



Heavy industry



Power generation



Power distribution



Railway equipment

DESCRIPTION

Timer relays of the RDT.15 / RDT.16 and RGTO series are delay-on-drop-out devices using a capacitor wired in parallel with the coil. They require no auxiliary power supply during the timing step. The delay can be fixed (RDT.15), or adjustable (RDT.16, RGTO), from 0.1s to 60s. The delay capacitor is fitted internally on all versions.

The construction of the relays and their simplified mechanical design combine to ensure these products offer high reliability in operation, as proven by their use for over 40 years in electrical energy transport and distribution systems, and fixed equipment used in the railway sector.

The contacts used for relays of the RDT.15 and RDT.16 series are of a type able to give good levels of performance both with high and strongly inductive d.c. loads, and with particularly low loads such as interface signals. Knurled contacts ensure not only better self-cleaning characteristics, but also lower ohmic resistance thanks to multiple points of electrical connection, thereby extending the electrical life expectancy of the component.

Typical sectors of use are among the most demanding, such as, for example, electricity generating stations, electrical transformer stations, fixed equipment for railways, or industries using continuous production processes (chemical and petrochemical, rolling mills, cement factories, etc.).

Like all AMRA relays, models of the RDT.15-16 and RGTO series are assembled as part of a controlled manufacturing process in which every step of production is verified by the next step in succession. In effect, each relay is calibrated and tested individually, by hand, in such a way as to guarantee top reliability.

Models	Number of timed contacts	Nominal current	Time delay	Time settings range
RDT.15x	4	10A	On drop-out, fixed	0.1...1s
RDT.161	4	10A	On drop-out, adjustable	0.1...6s
RGTO23x	1	5A	On drop-out, adjustable	3...60s

FOR CONFIGURATION OF PRODUCT CODE, SEE "ORDERING SCHEME" TABLE

Coil data	RDT.15x	RDT.161	RGTO23x
Nominal voltages Un ⁽¹⁾	DC: 24-48-110-125-220	DC: 24-48-110-125-220	AC: 24-48-110-125-220
Consumption at Un (DC/AC)	3.5W		1.5W
Operating range	DC: 80...120% Un AC: 85...110% Un		
Type of duty	Continuous		
Drop-out voltage ⁽²⁾	DC: > 5% Un AC: > 15% Un		

(1) Other values on request.

(2) Limit value for supply voltage, expressed as % of the nominal value, beneath which the relay is certain to be de-energized.

Contact data	RDT.15x, RDT.161	RGTO23x
Number and type	4 SPDT, form C	2 SPDT, form C
Current	10A	5A
Nominal ⁽¹⁾	13A for 1min - 20A for 1s	-
Maximum peak ⁽²⁾	100A for 10ms	-
Maximum pulse ⁽²⁾		
Example of electrical life expectancy ⁽³⁾	0.2A - 110Vdc - L/R 40ms - 10 ⁵ operations - 1,800 operations/hour	0.2A - 110Vdc - L/R 40ms - 10 ⁵ operations - 1,200 operations/hour
Minimum load	200mW (10V, 10mA)	
Maximum breaking voltage	250 Vdc / 300 Vac	

(1) Maximum peak and pulse currents are those currents that can be handled, for a specified time, by the contact. They do not refer to steady or interrupted currents.

(2) For other examples, see electrical life expectancy curves.

Insulation	RDT.15x - RDT.161	RGTO23x
Insulation resistance (at 500Vdc) between electrically independent circuits and between these circuits and ground between open contact parts	> 10,000 MΩ > 10,000 MΩ	> 10,000 MΩ > 10,000 MΩ
Withstand voltage at industrial frequency between electrically independent circuits and between these circuits and ground between open contact parts between adjacent contacts	2 kV (1 min.) - 2.2kV (1 s) 2 kV (1 min.) - 2.2kV (1 s) 2 kV (1 min.) - 2.2kV (1 s)	2 kV (1 min.) - 2.2kV (1 s) 1 kV (1 min.) - 1.1kV (1 s)
Impulse withstand voltage (1.2/50µs - 0.5J) between electrically independent circuits and between these circuits and ground between open contact parts	5 kV 2.5 kV	2.5 kV 2 kV

Mechanical specifications	RDT.15x	RDT.161	RGTO23x
Mechanical life expectancy	20x10 ⁶ operations		
Maximum switching rate Mechanical	3600 operations/hour		
Degree of protection	IP40		
Dimensions (mm)	40x40x75 ⁽¹⁾	40x40x82 ⁽¹⁾	50x45x112 ⁽¹⁾
Weight (g)	130	130	260

1. Output terminals excluded.

Environmental specifications	
Operating temperature	-25 to 55°C
Storage and shipping temperature	-25 to 70°C
Relative humidity	Standard: 75% RH - Tropicalized: 95% RH
Fire behaviour	V0

Standards and reference values

EN 61810-1, EN 61810-2, EN 61810-7
 EN 60695-2-10
 EN 50082-2
 EN 60529

Electromechanical elementary relays
 Fire behaviour
 Electromagnetic compatibility
 Degree of protection provided by enclosures

Unless otherwise specified, products are designed and manufactured according to the requirements of the European and International standards indicated above.
 In accordance with EN 61810-1, all items of technical data are referred to ambient temperature 23 °C, atmospheric pressure 96kPa and 50% humidity.
 Tolerance for coil resistance, nominal electrical input and nominal power is $\pm 7\%$.

Configurations - Options

TROPICALIZATION Surface treatment of the coil with protective coating for use with RH 95%.

Ordering scheme

Product code	Application ⁽¹⁾	Configuration A	Configuration B	Type of power supply	Type of input supply (V) ⁽²⁾	Finish ⁽³⁾	Keying position code ⁽⁴⁾
RDT	E: Energy	15: fixed duration	1: Fixed duration 0.1s 2: Fixed duration 0.2s 3: Fixed duration 0.5s 4: Fixed duration 1s	C: Vdc A: Vac 50 Hz H: Vac 60 Hz	024 - 048 - 110 125 - 220	T: Tropicalized coil	xx
	F: Railway Fixed Equipment	16: adjustable duration	1: Adjustable from 0.1 to 6s				
RGTO	-	23: adjustable duration	3: Adjustable from 3 to 10s 4: Adjustable from 10 to 30s 5: Adjustable from 20 to 60s				

Example	RDT	E	16	1	C	110	T	
	RDTE161-C110/T = ENERGY series relay, with 4 SPDT contacts, time delay on drop-out adjustable from 0.1 to 6s, and 110Vdc tropicalized coil.							
	RGTO		23	3	C	024		
RGTO233-C024 = Relay with 2 contacts: 1 SPDT instantaneous, 1 SPDT time delay on drop-out adjustable from 3 to 10 seconds, and 24Vdc coil.								

(1) ENERGY: all applications except for railway.

RAILWAYS, FIXED EQUIPMENT: application on fixed power systems and electrical railway traction. For list of RFI approved and conforming products, consult dedicated catalogue "RAILWAY SERIES – RFI APPROVED".

Also available is the STATIONS series, with ENEL approved material meeting LV15/LV16 specifications. For list of ENEL compliant and type-approved products, consult dedicated catalogue "STATIONS SERIES – LV15-LV16-LV20".

(2) Other values on request.

(3) Optional value.

(4) Optional value. Positive mechanical keying is applied according to the manufacturer's model.

Wiring diagram

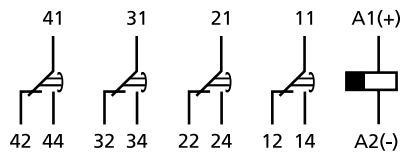

RDT.15x, RDT.161

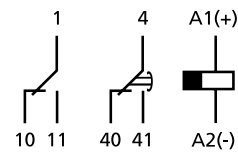

RGTO23x

Time delay – Switching time setting	RDT.15x	RDT.161	RGTO23x
Time setting	Fixed duration	By way of potentiometer, with slotted head screw	By way of potentiometer
Full scale times available	0.1s - 0.2s - 0.5s - 1s	6s	10s 30s 60s
Time setting range	-	0.1 - 6s ⁽¹⁾	3...10s 10...30s 30...60s
Operating accuracy (0.8...1.1 Un, t=20°C)	$\pm 3\%$ at low end of scale - $\pm 0.5\%$ at high end of scale		$\pm 10\%$ at high end of scale
Accuracy, repeatability	$\pm 2\%$		
Reset	<200ms		

(1) The setting controls are accessible by opening the flap on the cover of the relay.

Dimensions

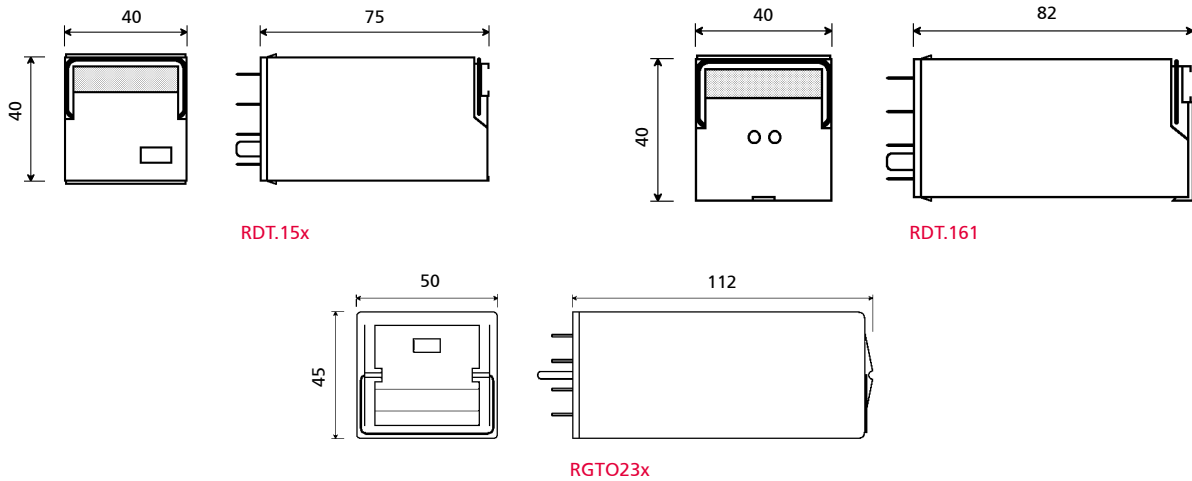

Electrical life expectancy

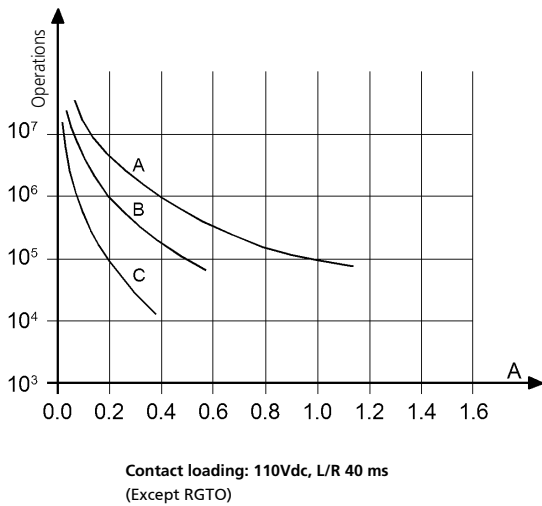

RDT_15x, RDT_161			
U	I (A)	L/R (ms)	Operations
110Vdc	0.2	40	1,000,000
110Vdc	0.5	40	150,000
110Vdc	1	10	100,000 (*)
220Vdc	0.2	10	100,000
U	I (A)	cosφ	Operations
110Vac	1	1	2,000,000
110Vac	1	0.5	1,500,000
110Vac	5	1	950,000
110Vac	5	0.5	500,000
220Vac	0.5	1	2,000,000
220Vac	1	0.5	800,000
220Vac	5	1	600,000
220Vac	5	0.5	500,000
220Vac	0.5	1	2,000,000
220Vac	5	1	500,000

Switching frequency: 1,200 operations/hour
(*) 600 operations/hour

Sockets and retaining clips		RDTE15x, RDTE161			RGTO23x	
Type of installation	Type of outputs	Socket	Clip for RDTE15x	Clip for RDTE161	Socket	Clip
Wall or DIN H35 rail mounting	Screw	PAVD161	VM1822	VM1823	PAVG161	VM1222
Flush mounting	Double faston (4.8 x 0.8 mm)	-	-	-	PRDG161	VM1222
	Screw	PRVD161	-	-	PRVG161	VM1222
PCB-mount	Solder	PRCD161	-	-	-	-

Mounting tips

The preferred mounting position is on the wall, with the relay positioned horizontally in the reading direction on the nameplate. For correct use of the relays, they should be spaced apart by at least 5 mm in the horizontal direction and 20 mm in the vertical direction. This is to allow correct upward dissipation of the heat generated by the coil. Set these distances according to the socket used. Distances can be reduced depending on the environmental conditions during operation, and on the relay duty cycle. No special maintenance is required. Condensation can form inside the relay when powered up and the outside ambient temperature is cold; this is quite normal and does not affect the operation of the relay. The plastic materials of the relay do not possess hygroscopic properties.

Current-monitoring relay

4 contacts

2.13

TD SERIES



TD2003

OVERVIEW

- Plug-in instantaneous monostable relay, current-monitoring
- High performance, compact dimensions
- Self-cleaning knurled contacts
- Relay coupled automatically to socket, with no need for a retaining clip
- Wide variety of configurations and customizations
- Transparent cover, pull-out handle
- Label holder in cover for customer's use
- Positive mechanical keying for relay and socket

APPLICATIONS



Shipbuilding



Petroleum industry



Heavy industry



Power generation



Power distribution



Railway equipment



DESCRIPTION

The TD series comprises current-monitoring relays having 4 change-over contacts, which are derived from the RDME series and offer the same mechanical specifications and benefits. These relays can be wired in series with a circuit and used to detect the status of a load when under power. One specific application for this series of relays is the control of obstruction warning lights (obstructions on land, in the air, in the sea, navigation lights) where high levels of reliability and efficiency are indispensable factors in ensuring safety. These components are suitable both for general current monitoring purposes, and for specific types of warning light signals having different electrical specifications and response characteristics, such as filament, strobe and halogen lamps (courtesy of certain design stratagems and adjustment features).

The construction of the relays and their simplified mechanical design combine to ensure these products offer high reliability in operation, as proven by their use for over 40 years in electrical energy transport and distribution systems, and fixed equipment used in the railway sector.

The contacts used are of a type designed to give good levels of performance both with high and strongly inductive loads, and with particularly low loads such as interface signals. Knurled contacts ensure not only better self-cleaning characteristics, but also lower ohmic resistance thanks to multiple points of electrical connection, thereby extending the electrical life expectancy of the component.

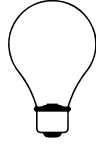
Like all AMRA relays, models of the TD series are assembled as part of a controlled manufacturing process in which every step of production is verified by the next step in succession. In effect, each relay is calibrated and tested individually, by hand, in such a way as to guarantee top reliability.

Models	Type of lamp		
	Filament	Strobe	Halogen
			
TD2001		•	
TD2002	• $\geq 1A$		
TD2003	• $< 1A$		
TD2004			•



FOR CONFIGURATION OF PRODUCT CODE, SEE "ORDERING SCHEME" TABLE



Coil data	
Input current	According to type of lamp (from 40mA to 5A) ⁽¹⁾
Consumption at Un (DC/AC)	1 W
Operating range	80...110% Un
Type of duty	Continuous

(1) It may be necessary to provide us with a sample of the lamp to be monitored, in order to ensure correct sizing of the relay.



Contact data	
Number and type	4 SPDT, form C
Current	10A 13A for 1min - 20A for 1s 100A for 10ms
Nominal ⁽¹⁾	
Maximum peak ⁽²⁾	
Maximum pulse ⁽²⁾	
Example of electrical life expectancy ⁽³⁾	0.2A - 110Vdc - L/R 40ms - 10 ⁵ operations - 1,800 operations/hour
Minimum load	200mW (10V, 10mA)
Maximum breaking voltage	250 Vdc / 300 Vac
Contact material	AgCdO (moving contacts) - AgNi (fixed contacts)

(1) On all contacts simultaneously, reduction of 30%.

(2) Maximum peak and pulse currents are those currents that can be handled, for a specified time, by the contact. They do not refer to steady or interrupted currents.

(3) For other examples, see electrical life expectancy curves.

(4) Unless specified otherwise, the operating time signifies until stabilization of the contact (including bounces).



Insulation	
Insulation resistance (at 500Vdc)	
between electrically independent circuits and between these circuits and ground	> 10,000 M Ω
between open contact parts	> 10,000 M Ω
Withstand voltage at industrial frequency	
between electrically independent circuits and between these circuits and ground	2 kV (1 min.) - 2.2kV (1 s)
between open contact parts	2 kV (1 min.) - 2.2kV (1 s)
between adjacent contacts	2 kV (1 min.) - 2.2kV (1 s)
Impulse withstand voltage (1.2/50 μ s - 0.5J)	
between electrically independent circuits and between these circuits and ground	5 kV
between open contact parts	3 kV



Mechanical specifications	
Mechanical life expectancy	20x10 ⁵ operations
Maximum switching rate	3600 operations/hour
Degree of protection	IP40
Dimensions (mm)	40x40x75 ⁽¹⁾
Weight (g)	130

(1) Output terminals excluded.

Environmental specifications

Operating temperature	-25 to 55°C
Storage and shipping temperature	-25 to 70°C
Relative humidity	Standard: 75% RH - Tropicalized: 95% RH
Fire behaviour	V0

Standards and reference values

EN 61810-1, EN 61810-2, EN 61810-7	Electromechanical elementary relays
EN 60695-2-10	Fire behaviour
EN 50082-2	Electromagnetic compatibility
EN 60529	Degree of protection provided by enclosures

Unless otherwise specified, products are designed and manufactured according to the requirements of the European and International standards indicated above. In accordance with EN 61810-1, all items of technical data are referred to ambient temperature 23 °C, atmospheric pressure 96kPa and 50% humidity. Tolerance for coil resistance, nominal electrical input and nominal power is ±7%.

Configurations - Options

TROPICALIZATION	Surface treatment of the coil with protective coating for use with RH 95%.
-----------------	--

Ordering scheme

Product code	Application ⁽¹⁾	Type of power supply	Nominal voltage (A) ⁽¹⁾	Finish ⁽²⁾	Keying position code ⁽³⁾
TD200	1: Strobe lamps 2: Filament lamps (I ≥ 1A) 3: Filament lamps (I < 1A) 4: Halogen lamps	U: I dc/ac	0.04 - 5.0 ⁽⁴⁾	T: Tropicalized coil	xx

Example	TD200	1	U	070	
	Example: TD2001-U070/T = ENERGY series relay with 4 standard SPDT contacts, 70mA coil				

- (1) Value depending on the lamp (model, power, input voltage, etc.).
 (2) Optional value.
 (3) Optional value. Positive mechanical keying is defined according to the manufacturer's model.
 (4) For currents < 1A the power input to the coil is expressed in mA (e.g. 40mA = U040).
 For currents ≥ 1A the power input to the coil is expressed in A (e.g. 2A = U2.0 - 1.7A = U1.7).

Available values (others on request)

Relay type	Circuit power input	Filament								Halogen	Strobe
		15	25	40	50	60	65	100	300	W	J
TD2001	U										
	12-24	-	-	-	-	-	-	-	-	-	U450
	110	-	-	-	-	-	-	-	-	-	U070
TD2002	230	-	-	-	-	-	-	-	-	-	U040
	24	-		U1.6		U2.5		U4.1	-	-	-
TD2003	220	-	-	-	-	-	-	-	U1.4	-	-
	110			U360	U450	U540		U900	-	-	-
TD2004	220	U070	U110	U180	U225	U270	U300	U450	-	-	-
	24	-	-	-	-	-	-	-	-	U2.1	-

Note: contact us for other values.

Wiring diagram

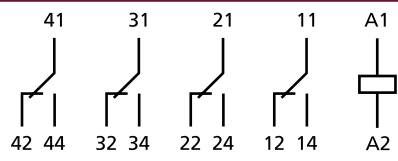

TD200x

Dimensions

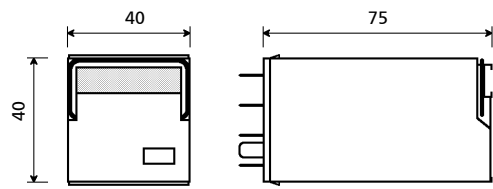

TD200x

Electrical life expectancy

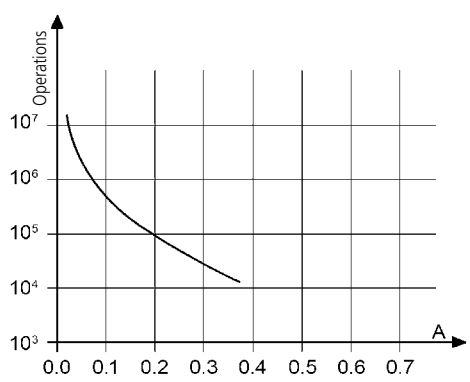

Contact loading: 110Vdc, L/R 40 ms

U	I (A)	L/R (ms)	Operations
110Vdc	0.2	40	500,000
220Vdc	0.2	10	80,000
U	I (A)	cosφ	Operations
110Vac	1	1	1,200,000
110Vac	1	0.5	1,000,000
110Vac	5	1	500,000
110Vac	5	0.5	300,000
220Vac	0.5	1	1,200,000
220Vac	1	0.5	500,000
220Vac	5	1	400,000
220Vac	5	0.5	300,000

Switching frequency: 1,200 operations/hour
(* 600 operations/hour)

Sockets and retaining clips

Type of installation	Type of outputs	Model	Retaining clip
Wall or DIN H35 rail mounting	Screw	PAVD161	VM1822
Flush mounting	Screw	PRVD161	-
PCB-mount		PRCD161	-

Mounting tips

The preferred mounting position is on the wall, with the relay positioned horizontally in the reading direction on the nameplate. For correct use of the relays, they should be spaced apart by at least 5 mm in the horizontal direction and 20 mm in the vertical direction. This is to allow correct upward dissipation of the heat generated by the coil. Set these distances according to the socket used. Distances can be reduced depending on the environmental application conditions and on the relay duty cycle. No special maintenance is required. Condensation can form inside the relay when powered up and the outside ambient temperature is cold; this is quite normal and does not affect the operation of the relay. The plastic materials of the relay do not possess hygroscopic properties.

Notes

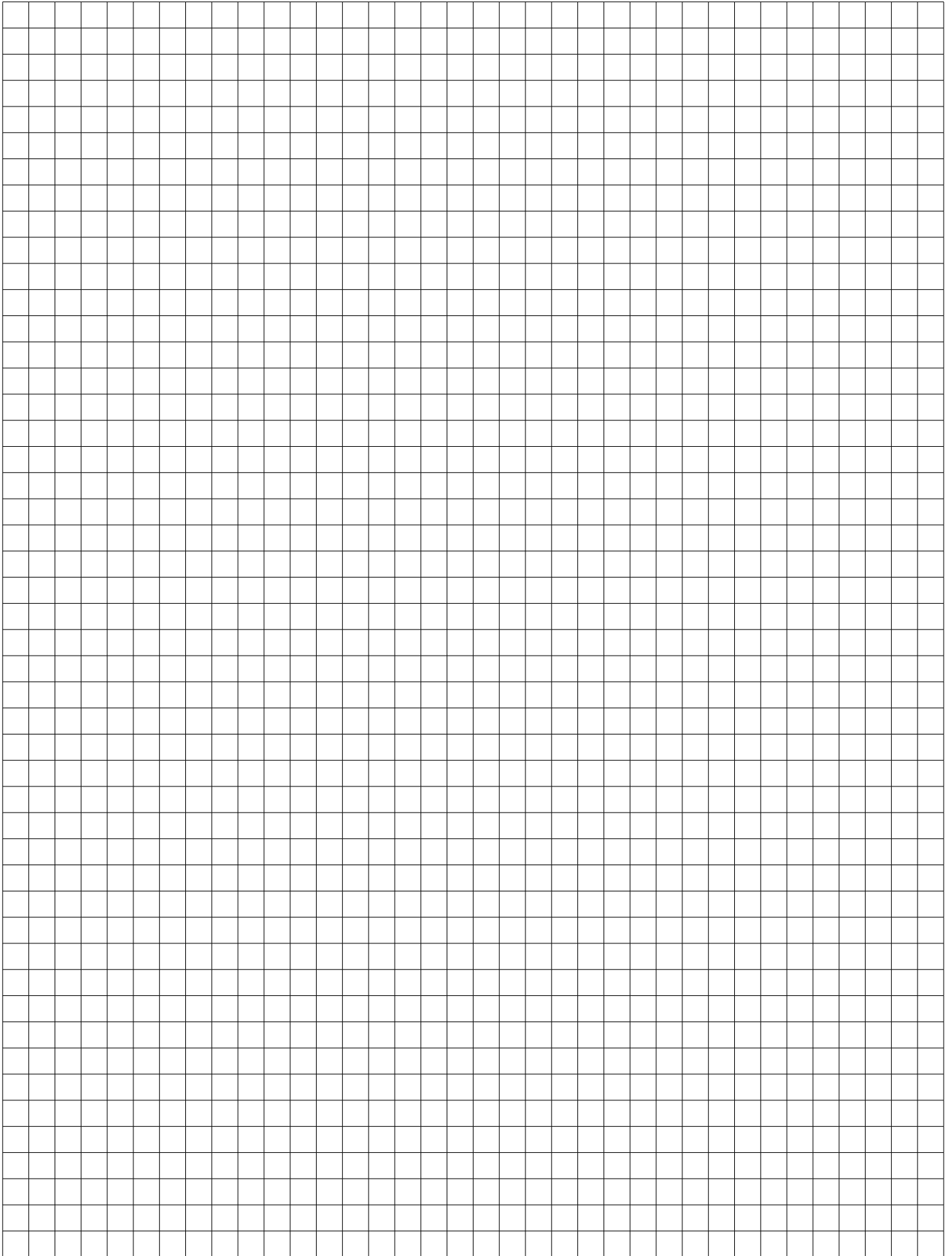





MOUNTING ACCESSORIES

- Sockets for AMRA line
- Sockets for MTI line
- AMRA numbering correspondence
- Retaining clips
- Polarizing pins

PAIR080
PAIR160
PAIR240
PAIR320
PAIR480

Connection: **FRONT**
Terminal type: **SPRING CLAMP**
Mounting: **PANEL / DIN RAIL**

Also suitable for



OVERVIEW

- Cable secured with spring clamp mechanism
- Insertion of lug with no need for tools
- Quick and easy wiring, saving more than half the time taken with conventional wiring
- Mounting to panel and 35mm DIN rail
- Excellent contact pressure on relay terminals
- Sturdy construction, no internal soldering
- Compatible with cable up to 2.5mm², bare (flexible or rigid) and with lug; 2 inputs per terminal
- Provision for fitment of keying pins
- Provision for fitment of retaining clip
- Protection IP20

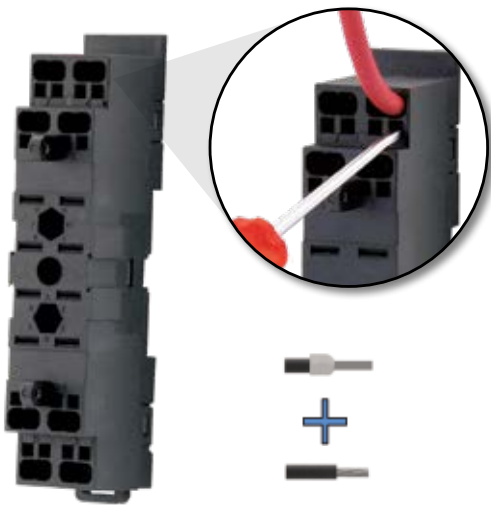

PAIR080



PAIR160



PAIR240

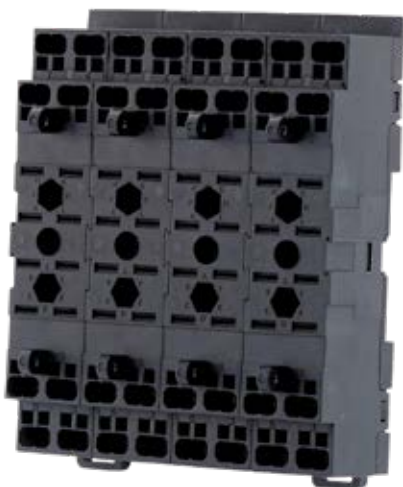

PAIR320



PAIR480

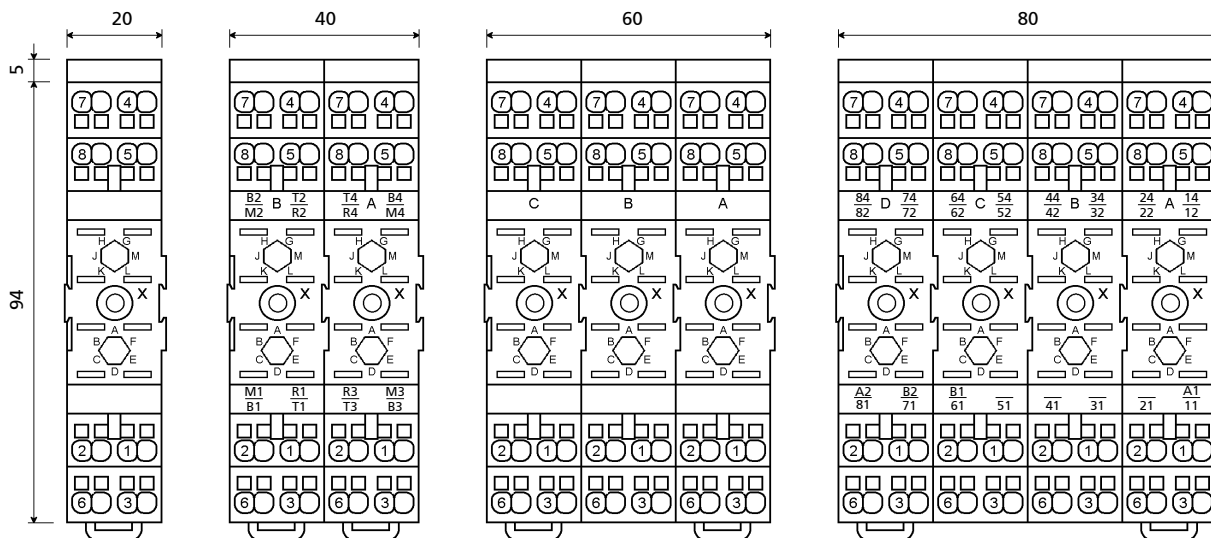

PAIR080

PAIR160

PAIR240

PAIR320

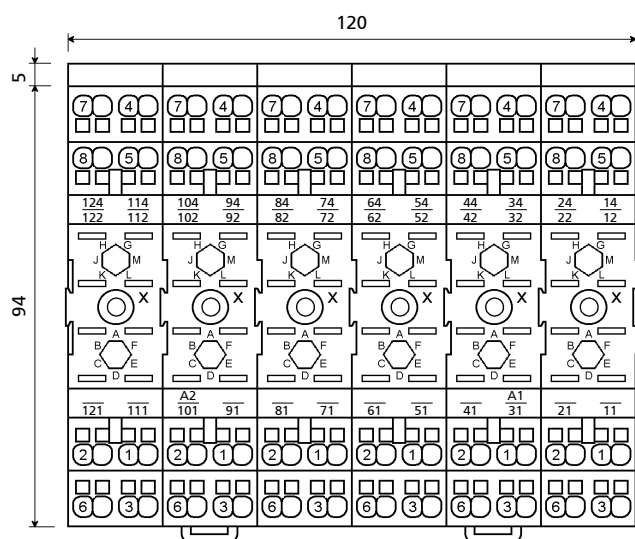

PAIR480

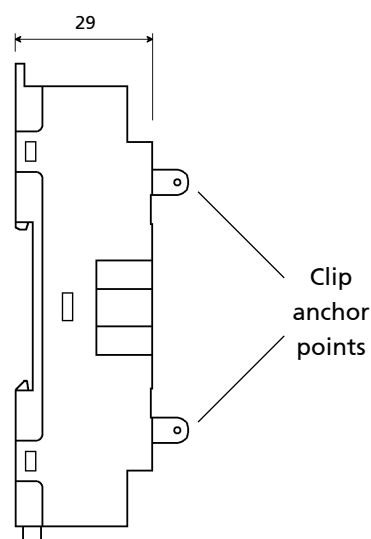

Side view

X = Fixing holes

Specifications

Weight: 62 / 124 / 186 / 248 / 370 g

Operating temperature: -50°C...+70°C

Storage temperature: -50°C...+85°C

Panel mounting:

- \varnothing holes: 3.2mm
- centre distance between adjacent holes: 20mm

Mounting to Omega support: H35 to DIN 46277/3 - EN 60715 standards

Degree of protection: IP20

Insulation voltage:

- between adjacent terminals: 2.5 kV 50 Hz for 1 min
- between terminals and external ground:
 - DIN H35 rail mounting: 4 kV 50 Hz for 1 min
 - Wall mounting: 3 kV 50 Hz for 1 min

Fire resistance: EN60695-2-1, UL94 - V0, EN45545-2, NFPA130

Standards: EN60255, EN60947, EN 61810, EN61373

Terminal type: spring clamp

Inputs for each relay terminal: 2

Minimum section of cable:

- cable without lug: 1 mm²
- cable with lug: 0,5 mm²

Maximum section of cable: 2,5 mm²

Wire stripping length, mm: 10 mm \pm 0.5 mm

Length of lug: 12 mm

Wiring with rigid cables or lug: pressure grip

Wiring with flexible cables, extraction of cables: using screwdriver type tool with slim shaft and slotted head measuring 2.5mm x 0.4mm, inserted perpendicularly to the socket.

50IP20-I DIN
 48BIP20-I DIN
 78BIP20-I DIN
 96IP20-I DIN
 156IP20-I DIN

Connection: **FRONT**
 Terminal type: **SCREW**
 Mounting: **PANEL / DIN RAIL**

Also suitable for



OVERVIEW

- Cable secured with screws
- Mounting to panel and 35mm DIN rail
- Sturdy construction
- Excellent contact pressure on relay terminals
- No internal soldering
- Inputs for maximum section 2.5 mm²
- Provision for fitment of keying pins
- Provision for fitment of retaining clip
- Protection IP20



50IP20-I DIN



48BIP20-I DIN



78BIP20-I DIN



96IP20-I DIN



156IP20-I DIN

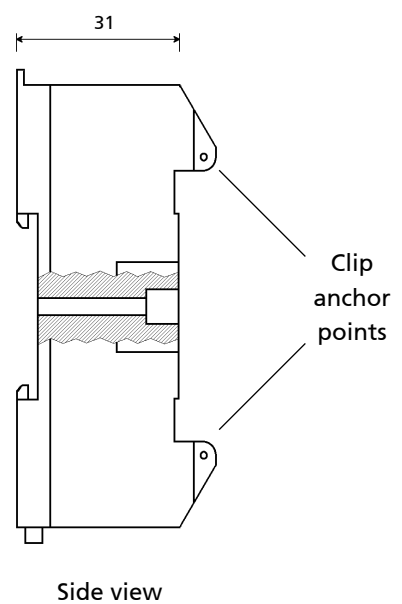
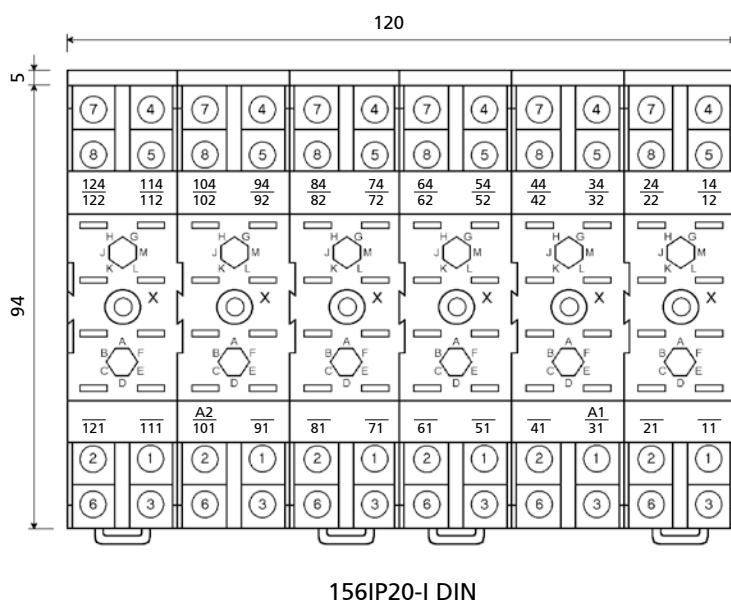
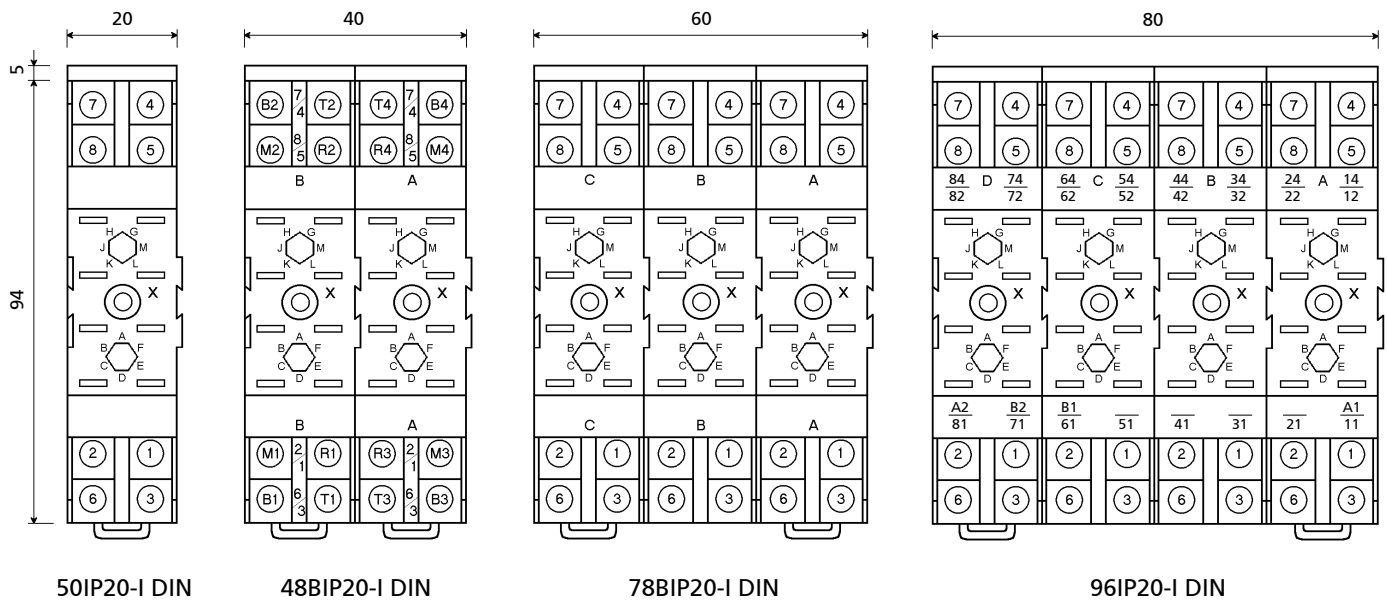

X = Fixing holes

Specifications

Weight: 70 / 140 / 210 / 280 / 415 g

Operating temperature: -50°C...+70°C

Storage temperature: -50°C...+85°C

Panel mounting:

- \varnothing holes: 4.2mm
- centre distance between adjacent holes: 20mm

Degree of protection: IP20

Dielectric strength: 2.5kV 50Hz 1min.

Mounting to Omega support: H35 to DIN 46277/3 - EN 60715 standards

Type and size of screw: M3 thread, cross head

Tightening torque: 0.5...0.6 Nm

Width of slot: 6.9mm

Maximum section of cable: 2 x 2.5 mm²

Fire resistance: EN60695-2-1, UL94 - V0, EN45545-2

Standards: EN60255, EN60947, EN 61810, EN61373

50L
48BL
78BL
96BL

Connection: **FRONT**
Terminal type: **SCREW**
Mounting: **PANEL**

Also suitable for



OVERVIEW

- Cable secured with removable screws
- Panel mounting
- Sturdy construction
- Excellent contact pressure on relay terminals
- No internal soldering
- Inputs for maximum section 2.5 mm²
- Provision for fitment of keying pins
- Provision for fitment of retaining clip
- Protection IP10



50L



48BL



78BL

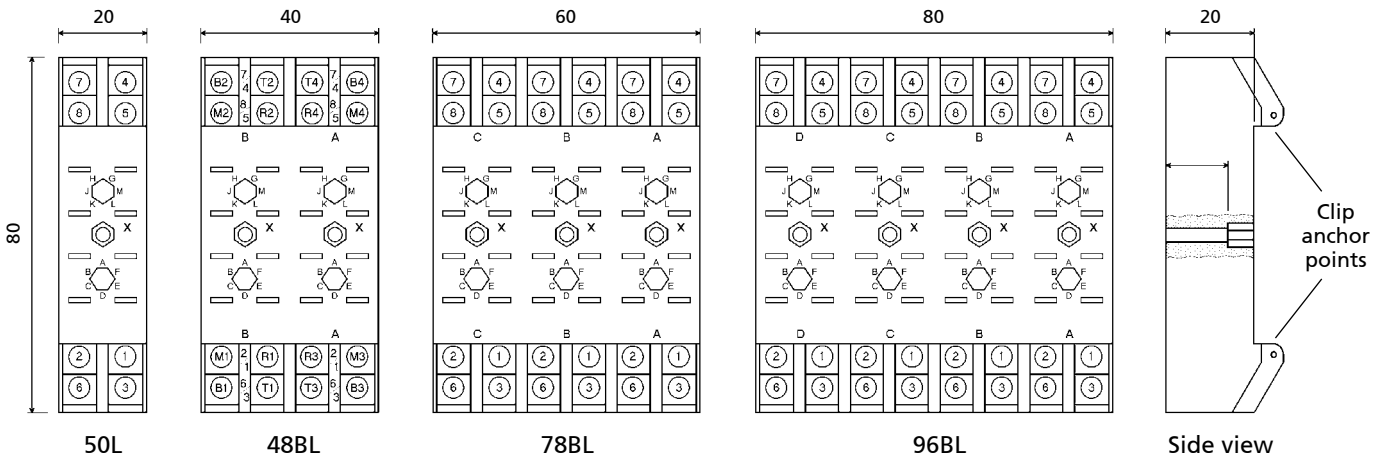

X = Fixing holes

Specifications

Weight: 36 / 72 / 108 / 144 g
Operating temperature: -25°C...+70°C
Storage temperature: -40°C...+85°C
Panel mounting:
 • ϕ holes: 4.2mm
 • centre distance between adjacent holes: 20mm
Degree of protection: IP10
Dielectric strength: 2.5kV 50Hz 1min.

Type and size of screw: M3 thread, cross head
 Removable screw for use with eyelet terminals
Tightening torque: 0.5...0.8 Nm
Width of slot: 7.1 mm
Maximum section of cable: 2 x 2.5 mm²
Fire resistance: EN60695-2-1, UL94 - V0, EN45545-2
Standards: EN60255, EN60947, EN 61810, EN61373

Connection: **REAR**
Terminal type: **SCREW**
Mounting: **PANEL**

53IL
43IL
73IL



Also suitable for



OVERVIEW

- Cable secured with removable screws
- Panel mounting
- Sturdy construction
- Excellent contact pressure on relay terminals
- No internal soldering
- Inputs for maximum section 2.5 mm²
- Provision for fitment of keying pins
- Provision for fitment of retaining clip
- Protection IP10



53IL



43IL



73IL



Detail of connections

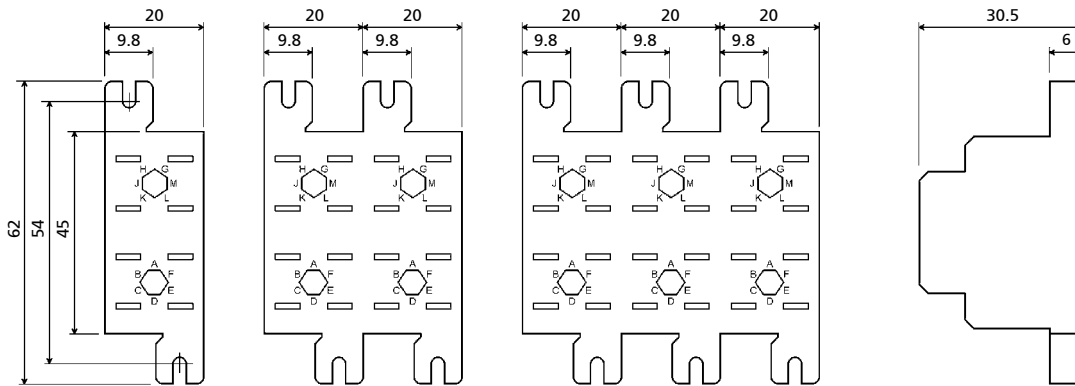

Side view

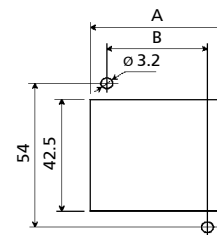
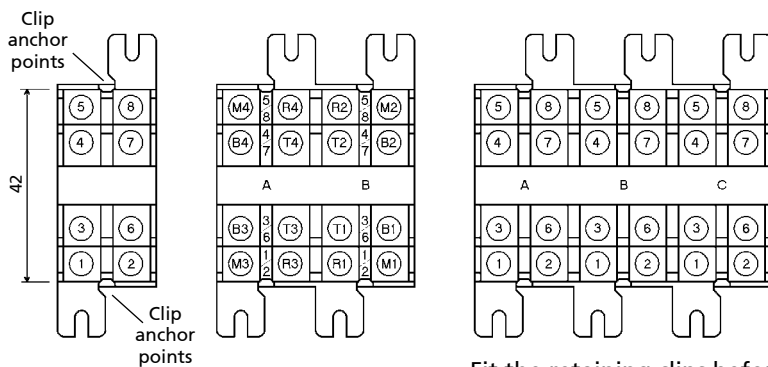

Drilling template

	A	B
53IL	20.5	10
43IL	40.5	30
73IL	60.5	50

Fit the retaining clips before attaching the connectors

Specifications

Weight: 41 / 82 / 123 g
Operating temperature: -25°C...+70°C
Storage temperature: -40°C...+85°C
Degree of protection: IP10
Dielectric strength: 2.5kV 50Hz 1min.
Type and size of screw: M3 thread, cross head
Removable screw for use with eyelet terminals

Tightening torque: 0.5...0.8 Nm
Width of slot: 5.4 mm
Maximum section of cable: 2 x 2.5 mm²
Fire resistance: EN60695-2-1, UL94 - V0, EN45545-2
Standards: EN60255, EN60947, EN 61810, EN61373

ADF1
ADF2
ADF3
ADF4
ADF6

Connection: **REAR**
Terminal type: **DOUBLE FASTON**
Mounting: **PANEL**

Also suitable for



OVERVIEW

- Connection of cable with faston clip
- 2 inputs for each relay terminal
- Sturdy construction
- Excellent contact pressure on relay terminals
- No internal soldering
- Provision for fitment of keying pins
- Provision for fitment of retaining clip
- Protection IP20



ADF1



ADF2



Detail of connections



ADF3



ADF4



ADF6

ADF1

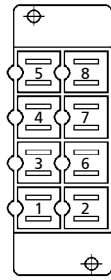
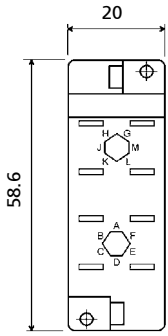

Rear view

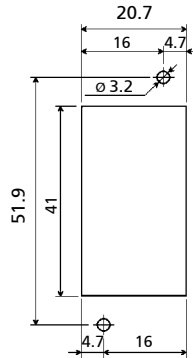

Drilling template

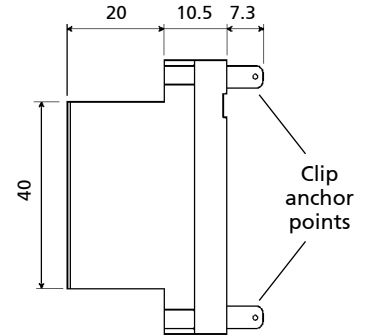

Side view

ADF2

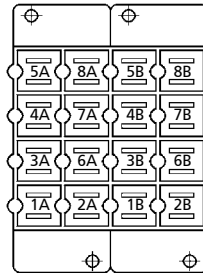
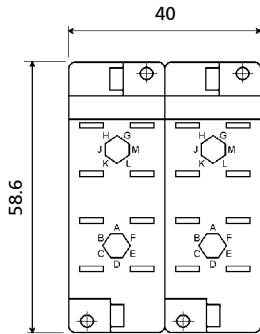

ADF2-BIPOK
Model with "BIPOK"
numbering

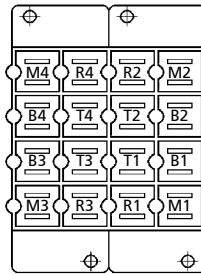

ADF2-OK
Model with "OK"
numbering

Rear view

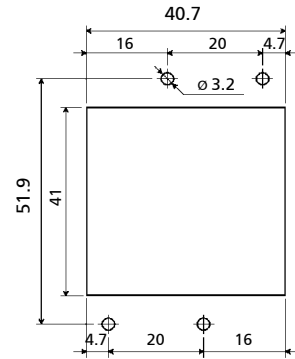

Drilling template

ADF3

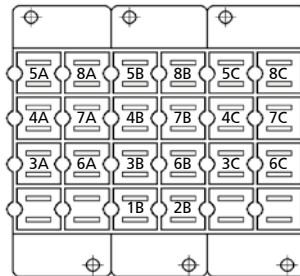
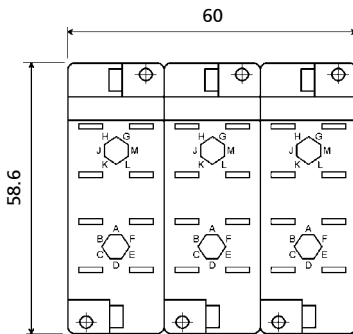

ADF3-TRIPOK
Model with "TRIPOK"
numbering
Rear view

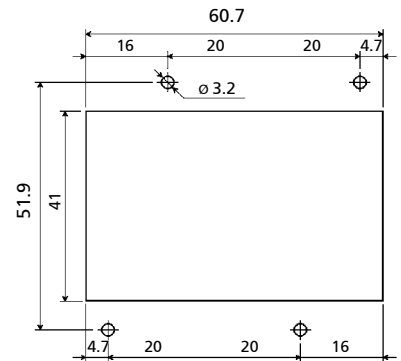

Drilling
template

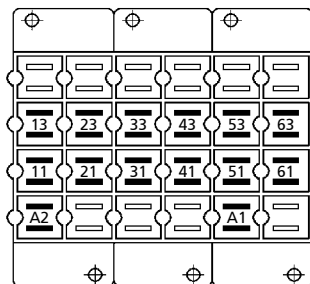

ADF3-RVLV16/1
Model with
numbering for RVLV16/1

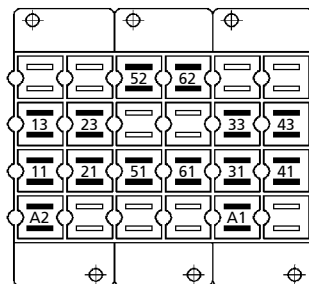

ADF3-RVLV16/2
Model with
numbering for RVLV16/2

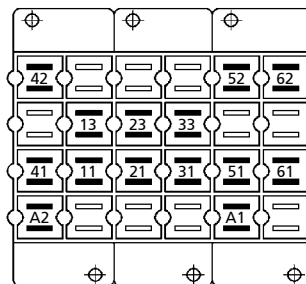

ADF3-RVLV16/3
Model with
numbering for RVLV16/3

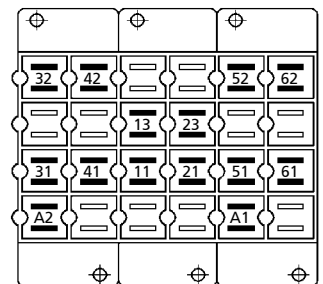

ADF3-RVLV16/5
Model with
numbering for RVLV16/5

ADF4

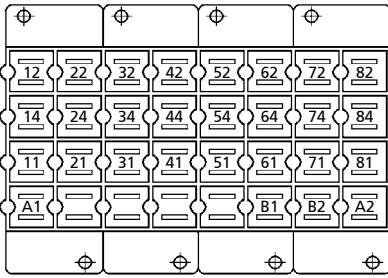
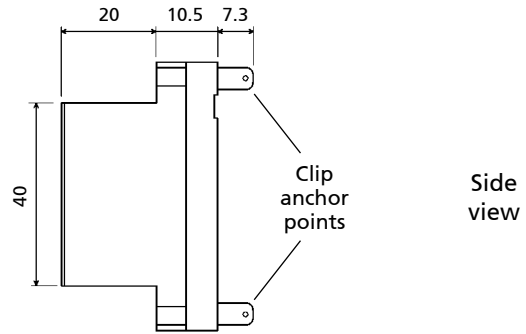
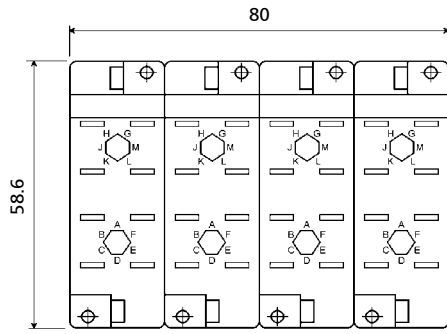

ADF4 Rear view

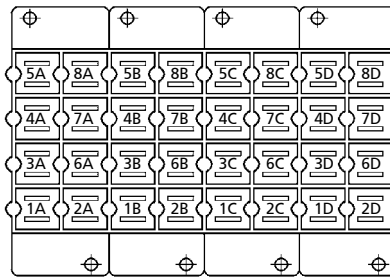

ADF4-E1 Rear view

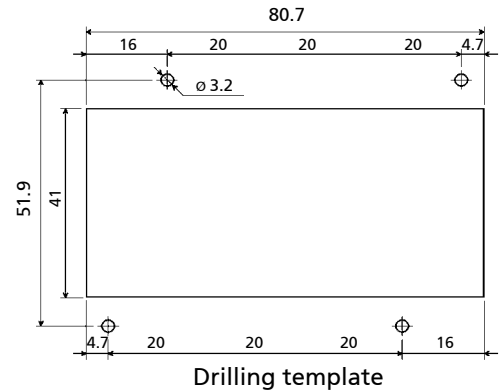

Drilling template

ADF6

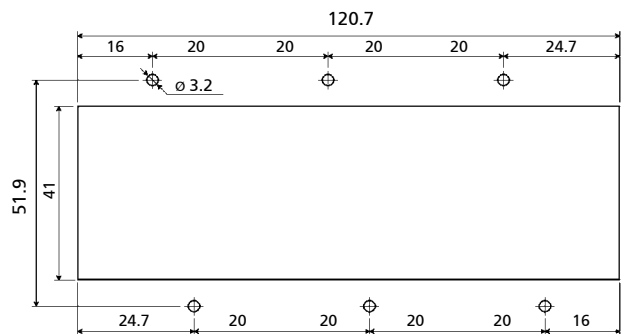
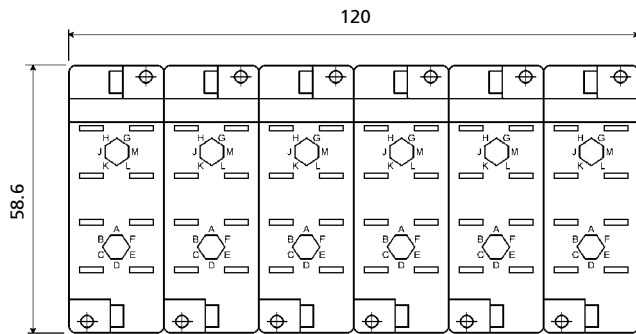

Drilling template

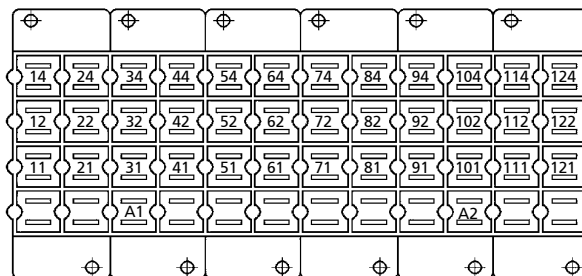

ADF6-ESAPOK / Model with "ESAPOK" numbering

Specifications

Weight: 32 / 64 / 96 / 128 / 192 g

Operating temperature: -25°C...+70°C

Storage temperature: -40°C...+85°C

Degree of protection: IP10

Dielectric strength: 2.5kV 50Hz 1min.

Type and size of faston clip: 2 x 4.8x0.8

Width of slot: 8mm

Maximum section of cable: 2 x 2.5 mm²

Fire resistance: EN60695-2-1, UL94 - V0, EN45545-2,

Standards: EN60255, EN60947, EN 61810, EN61373

Socket no.: 65
 Terminal type: **SOLDER**
 Mounting: **PCB**

Also suitable for



OVERVIEW

- PCB-mount
- Sturdy construction
- Excellent contact pressure on relay terminals
- No internal soldering
- No maintenance
- Provision for fitment of keying pins
- Provision for fitment of retaining clip

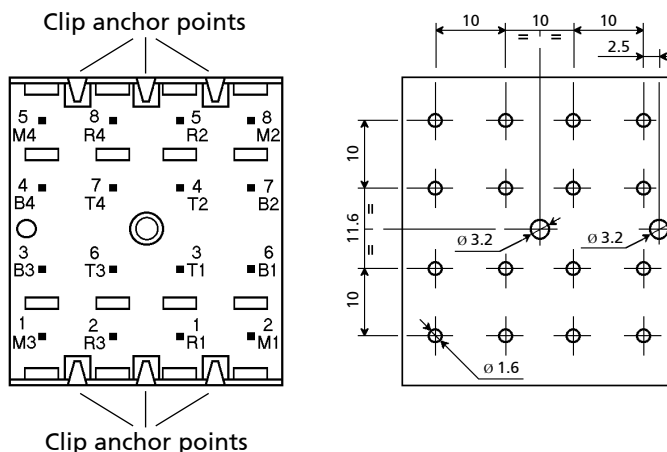
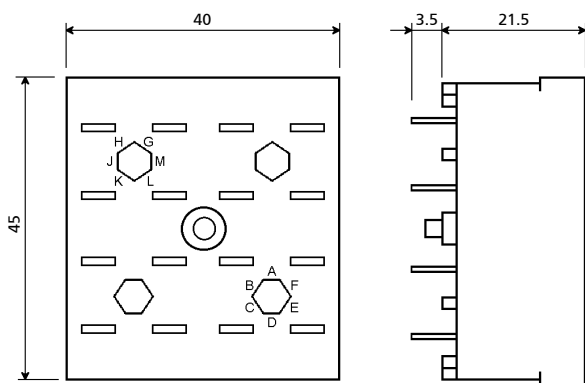

Specifications

Weight: 51 g

Operating temperature: -25°C...+70°C

Storage temperature: -40°C...+85°C

Dielectric strength: 2.5kV 50Hz 1min.

Type and size of terminals: solder, \varnothing 1.6mm

Fire resistance: EN60695-2-1, UL94 - V0, EN45545-2, NFPA130

Standards: EN60255, EN60947, EN 61810, EN61373



OVERVIEW

- Cable secured with spring clamp mechanism
- Insertion of lug with no need for tools
- Quick and easy wiring, saving more than half the time taken with conventional wiring
- Mounting to panel and 35mm DIN rail
- Excellent contact pressure on relay terminals
- Sturdy construction, no internal soldering
- Compatible with cable up to 2.5mm², bare (flexible or rigid) and with lug; 2 inputs for each terminal
- Provision for fitment of retaining clip
- Protection IP20



PAIR085

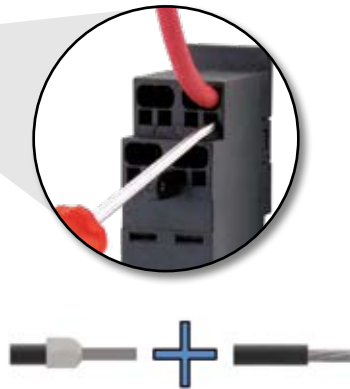

PAIR165

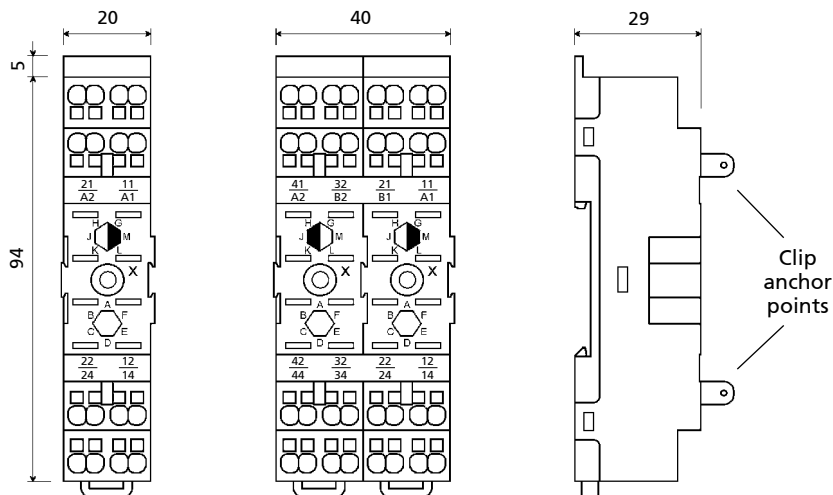

⚠ It is not possible to use keying pins with relays of the RCM and RDM series

X = Fixing holes

Specifications

Weight: 62 / 124 / 186 / 248 / 370 g

Operating temperature: -50°C...+70°C

Storage temperature: -50°C...+85°C

Panel mounting:

- \varnothing holes: 3.2mm
- centre distance between adjacent holes: 20mm

Mounting to Omega support: H35 to DIN 46277/3 - EN 60715 standards

Degree of protection: IP20

Insulation voltage:

- between adjacent terminals: 2.5 kV 50 Hz for 1 min
- between terminals and external ground:
 - DIN H35 rail mounting: 4 kV 50 Hz for 1 min
 - Wall mounting: 3 kV 50 Hz for 1 min

Fire resistance: EN60695-2-1, UL94 - V0, EN45545-2, NFPA130

Standards: EN60255, EN60947, EN 61810, EN61373

Connection: spring clamp

Inputs for each terminal: 2

Minimum section of cable: 2 x 1 mm²

Maximum section of cable: 2 x 2.5 mm²

Wire stripping length, mm: 10 mm \pm 0.5 mm

Length of lug: 12 mm

Wiring with rigid cables or lug: pressure grip

Wiring with flexible cables, extraction of cables: using screwdriver type tool with slim shaft and slotted head measuring 2.5mm x 0.4mm, inserted perpendicularly to the socket.

For relays of series: **C, D, G**
 Connection: **FRONT**
 Terminal type: **SCREW**
 Mounting: **PANEL / DIN RAIL**

PAVC081
 PAVD161
 PAVG161



OVERVIEW

- Cable secured with screws
- Mounting to panel and 35mm DIN rail
- Sturdy construction
- No internal soldering
- Provision for fitment of keying pins
- Provision for fitment of retaining clip
- Snap-in relay (PAVC, PAVD)
- Protection IP20



PAVC081



PAVD161



PAVG161

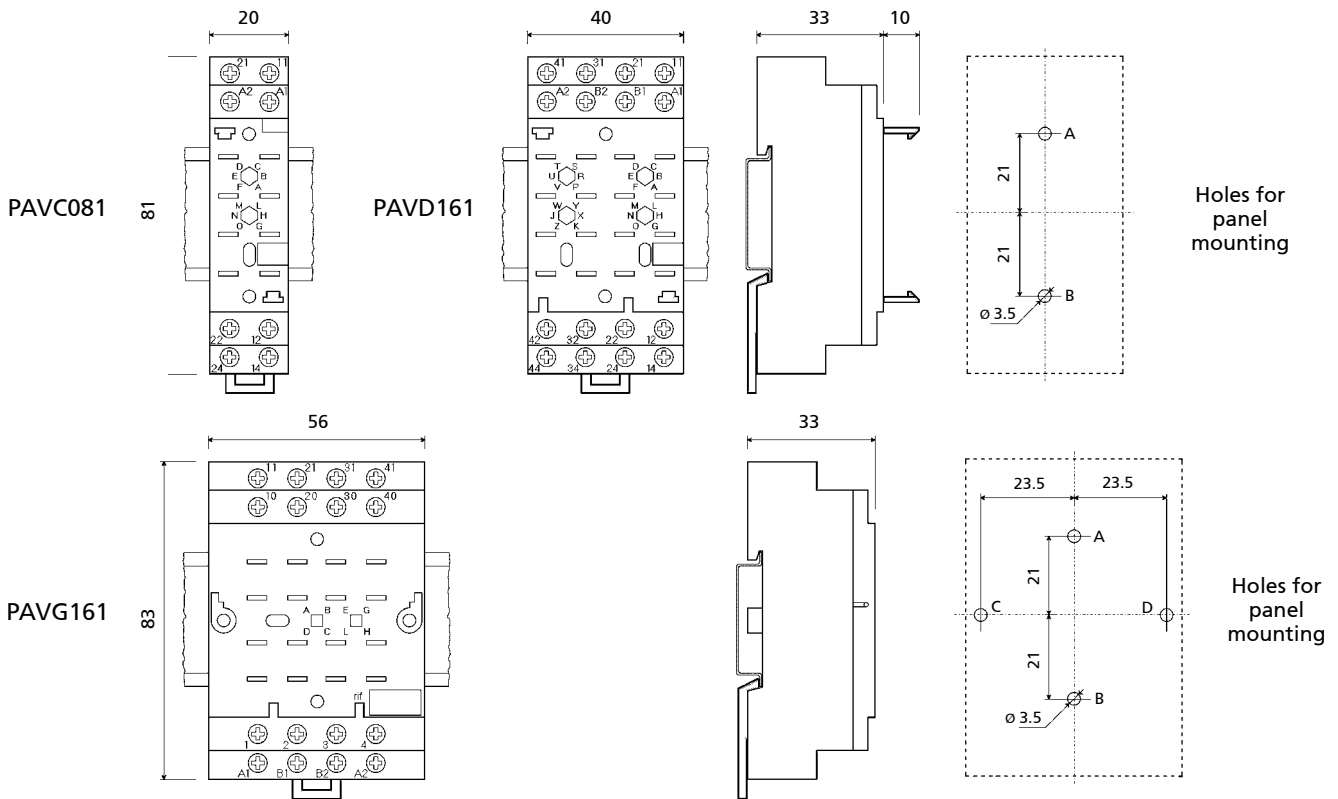

Specifications

Weight: 51 / 100 / 117 g

Operating temperature: -25°C...+55°C

Storage temperature: -40°C...+70°C

Panel mounting:

- \varnothing holes: 5.5mm

Mounting to Omega support: H35 to DIN 46277/3 - EN 60715 standards

Degree of protection: IP20

Dielectric strength: 2.5kV 50Hz 1min.

Type and size of screw: M3 thread, cross head

Tightening torque: 0.5...0.8 Nm

Width of slot: 7.1mm / 7.3 for PAVG161

Maximum section of cable: 2 x 2.5 mm²

Fire resistance: EN60695-2-1, UL94 - V0

Standards: EN60255, EN 61810

OVERVIEW

- Cable secured with screws
- Mounting to panel and 35mm DIN rail
- Sturdy construction
- No internal soldering
- Relay fastened with securing screws
- Provision for fitment of keying pins
- Protection IP20



PAVM321



PAVM481



PAVM801

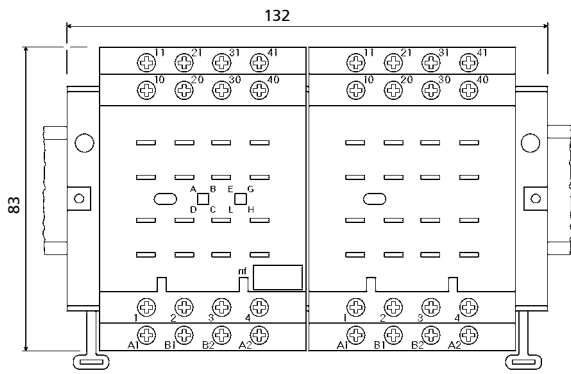

PAVM321

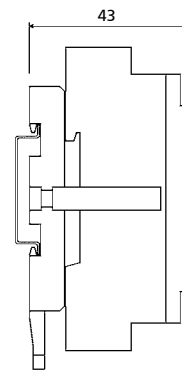

PAVM321
PAVM481
PAVM801
Side view

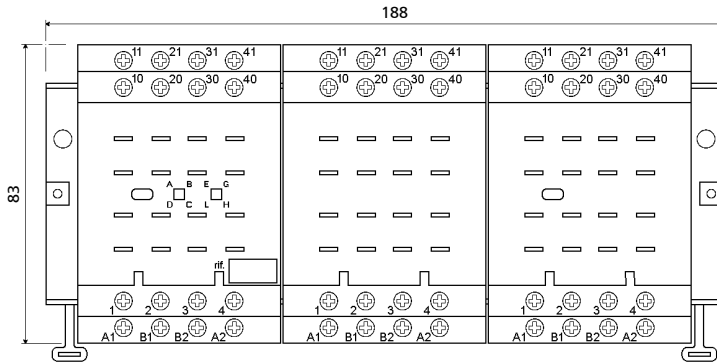

PAVM481

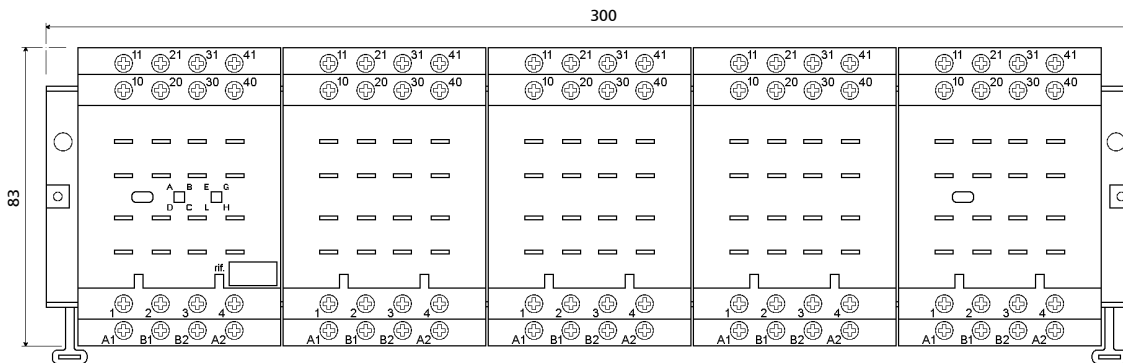

PAVM801

Outline and fixing	
Model	A
PAVM321	61
PAVM481	89
PAVM801	145

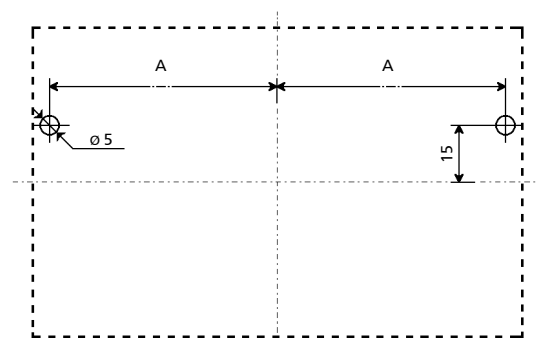

Fixing template

Specifications

Weight: 305 / 440 / 710 g

Operating temperature: -25°C...+55°C

Storage temperature: -40°C...+70°C

Panel mounting:

- \varnothing holes: 5mm

Mounting to Omega support: H35 to DIN 46277/3 - EN 60715 standards

Degree of protection: IP20

Dielectric strength: 2.5kV 50Hz 1min

Type and size of screw: M3 thread, cross head

Tightening torque: 0.5...0.8 Nm

Width of slot: 7.3mm

Maximum section of cable: 2 x 2.5 mm²

Fire resistance: EN60695-2-1, UL94 - V0

Standards: EN60255, EN 61810

OVERVIEW

- Cable secured with screws
- Panel mounting
- Sturdy construction
- No internal soldering
- Snap-in relay
- Provision for fitment of keying pins
- Protection IP10



PRVC081



Detail of connections



PRVD161

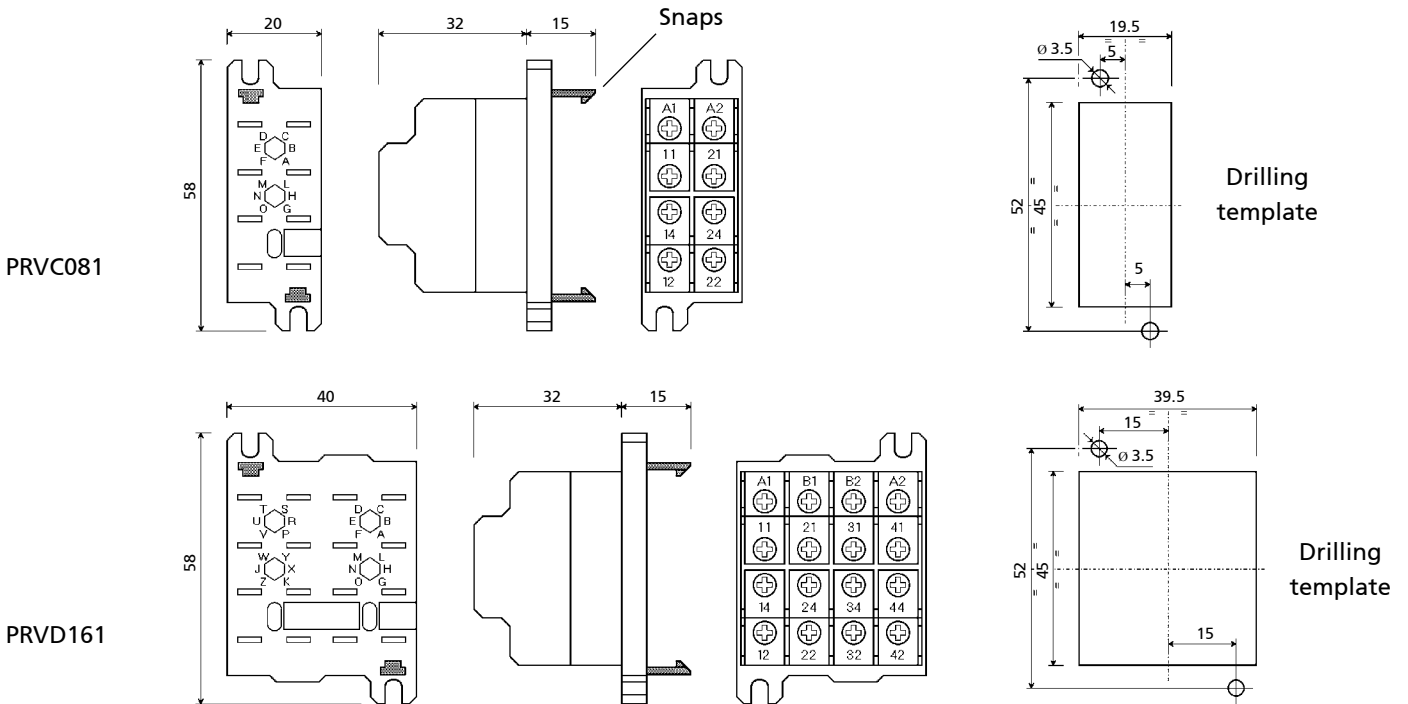

Specifications

Weight: 39 / 78 g
Operating temperature: -25°C...+55°C
Storage temperature: -40°C...+70°C
Panel mounting:
 • ϕ holes: 3.5mm
Degree of protection: IP10
Dielectric strength: 2.5kV 50Hz 1min

Type and size of screw: M3 thread, cross head
Tightening torque: 0.5...0.8 Nm
Width of slot: 7mm
Maximum section of cable: 2 x 2.5 mm²
Fire resistance: EN60695-2-1, UL94 - V0
Standards: EN60255, EN 61810

For relays of series: **G**
 Connection: **REAR**
 Terminal type: **SCREW**
 Mounting: **PANEL**

PRVG161

OVERVIEW

- Cable secured with screws
- Panel mounting
- Sturdy construction
- No internal soldering
- Provision for fitment of keying pins
- Provision for fitment of retaining clip
- Protection IP10



PRVG161

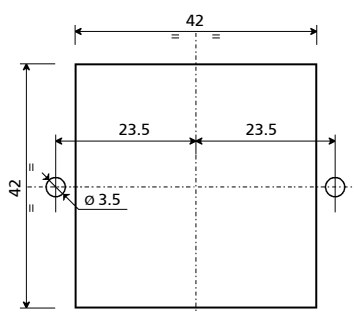
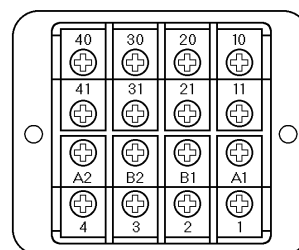
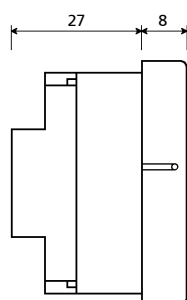
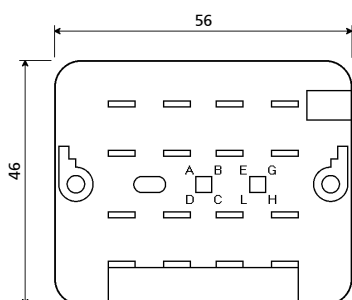

Drilling template

Specifications

Weight: 85 g

Operating temperature: -25°C...+55°C

Storage temperature: -40°C...+70°C

Panel mounting:

- \varnothing holes: 3.5mm

Degree of protection: IP10

Fire resistance: EN60695-2-1, UL94 - V0

Standards: EN60255, EN 61810

Dielectric strength: 2.5kV 50Hz 1min.

Type and size of screw: M3 thread, cross head

Tightening torque: 0.5...0.8 Nm

Width of slot: 7mm

Maximum section of cable: 2 x 2.5 mm²

OVERVIEW

- Cable secured with screws
- Panel mounting
- Sturdy construction
- No internal soldering
- Relay fastened with securing screws
- Provision for fitment of keying pins
- Protection IP10



PRVM321



Detail of connections



PRVM481



PRVM801

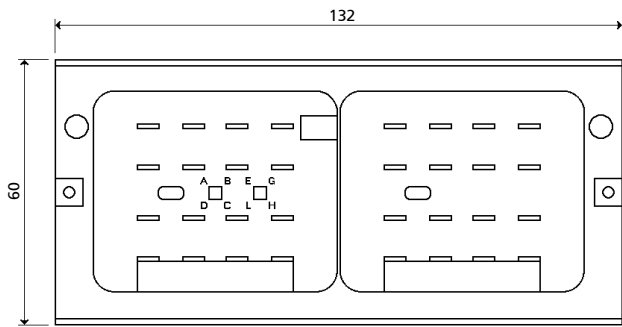

PRVM321

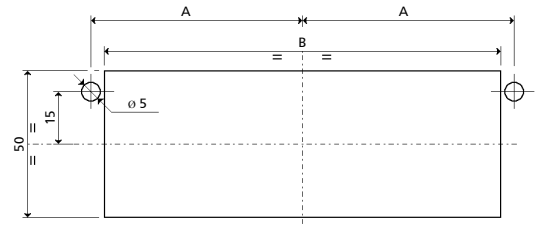

Drilling template

Model	A	B
PAVM321	61	110
PAVM481	89	166
PAVM801	145	278

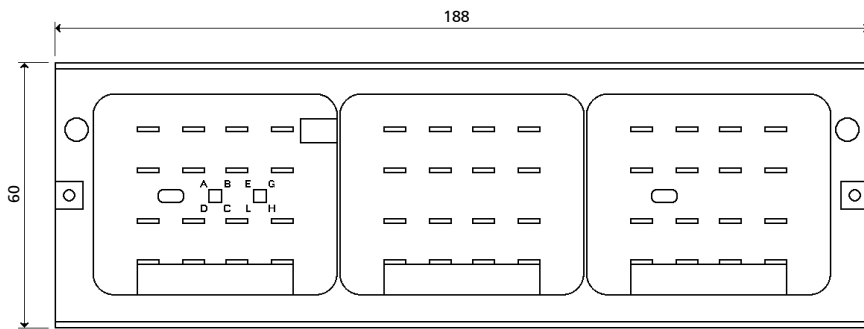

PRVM481

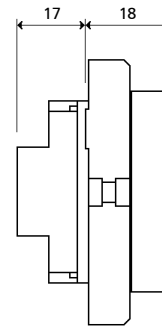

Side view

PRVM321
PRVM481
PRVM801

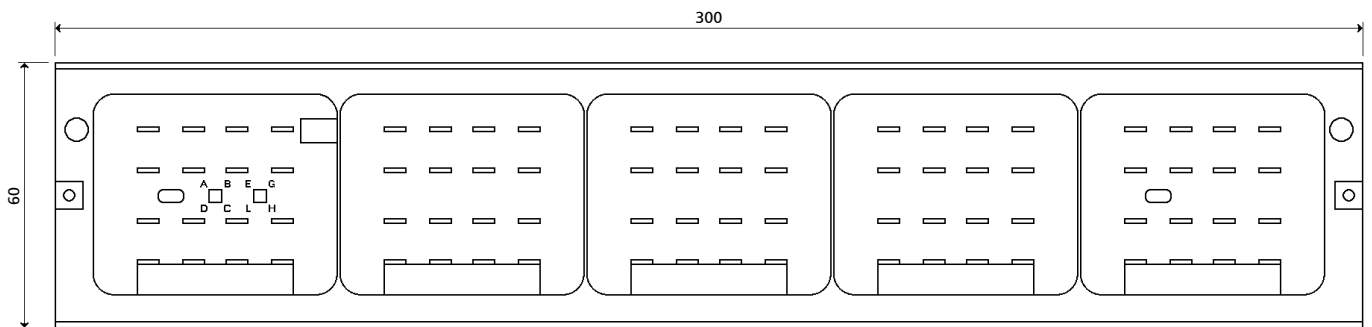

PRVM801

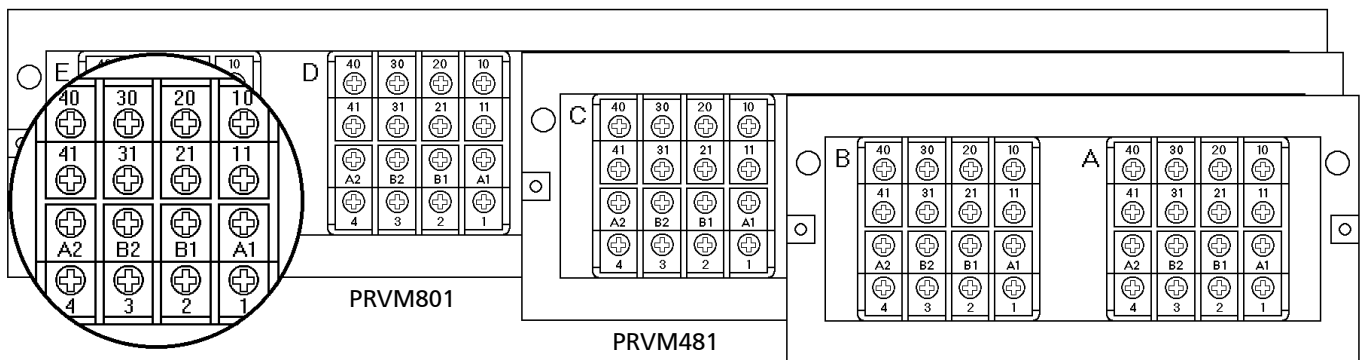

Specifications

Weight: 220 / 350 / 520 g
Operating temperature: -25°C...+55°C
Storage temperature: -40°C...+70°C
Panel mounting:
 • ϕ holes: 5mm
Degree of protection: IP10
Dielectric strength: 2.5kV 50Hz 1min

Type and size of screw: M3 thread, cross head
Tightening torque: 0.5...0.8 Nm
Width of slot: 7mm
Maximum section of cable: 2 x 2.5 mm²
Fire resistance: EN60695-2-1, UL94 - V0
Standards: EN60255, EN 61810

OVERVIEW

- Connection of cable with faston clip
- Panel mounting
- 2 inputs for each relay terminal
- Sturdy construction
- No internal soldering
- Relay fastened with securing screws
- Provision for fitment of keying pins
- Protection IP10



PRDM321



Detail of connections



PRDM481



PRDM801

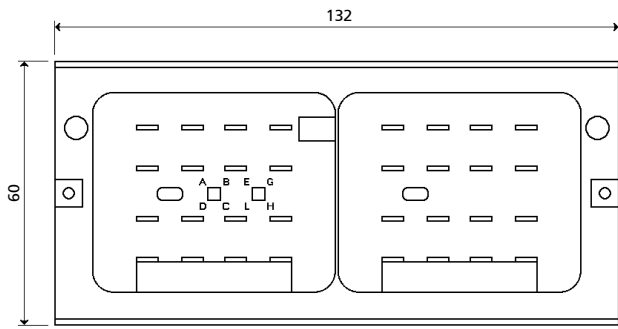

PRDM321

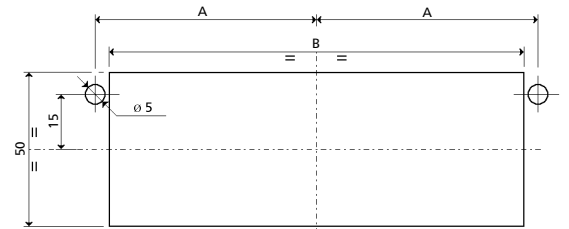

Drilling template

Model	A	B
PRDM321	61	110
PRDM481	89	166
PRDM801	145	278

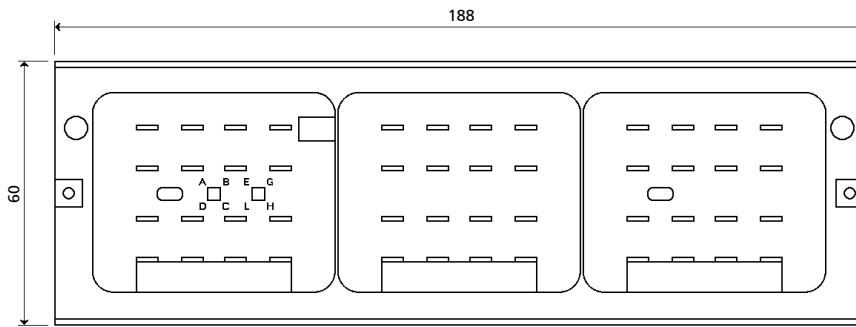

PRDM481

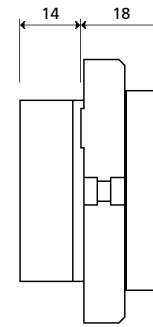

Side view

PRDM321
PRDM481
PRDM801

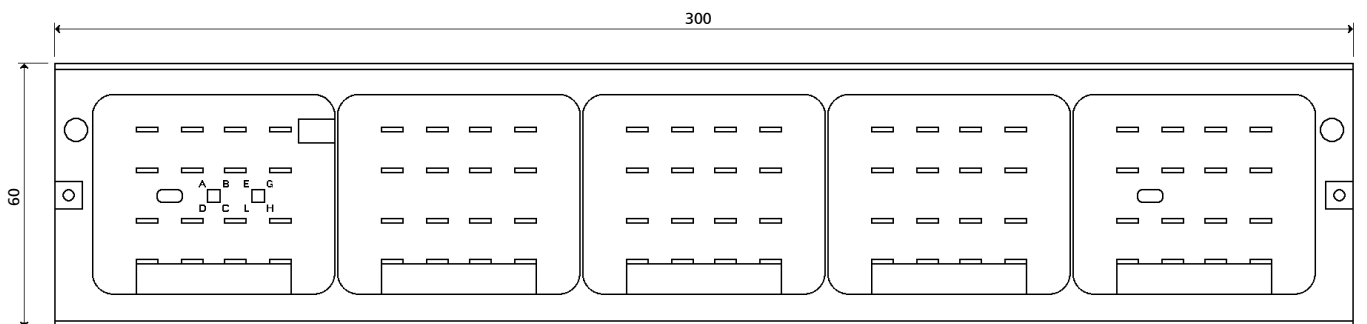

PRDM801

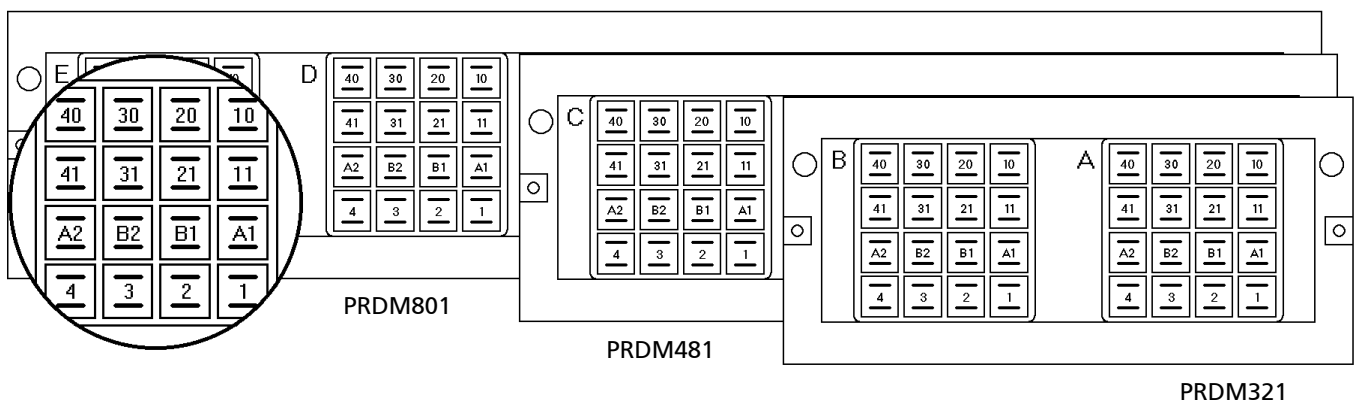

PRDM801

PRDM481

PRDM321

Specifications

Weight: 220 / 350 / 520 g

Operating temperature: -25°C...+55°C

Storage temperature: -40°C...+70°C

Panel mounting:

- \varnothing holes: 5mm

Degree of protection: IP10

Dielectric strength: 2.5kV 50Hz 1min

Type and size of faston: 2 x 4,8x0,8

Width of slot: 7,8mm

Maximum section of cable: 2 x 2,5 mm²

Fire resistance: EN60695-2-1, UL94 - V0

Standards: EN60255, EN 61810

OVERVIEW

- Connection of cable with faston clip
- Panel mounting
- Sturdy construction
- No internal soldering
- Snap-in relay (PRDC081)
- Provision for fitment of retaining clip (PRDG161)
- Provision for fitment of keying pins
- Protection IP10



PRDC081



Detail of connections



PRDG161



Detail of connections

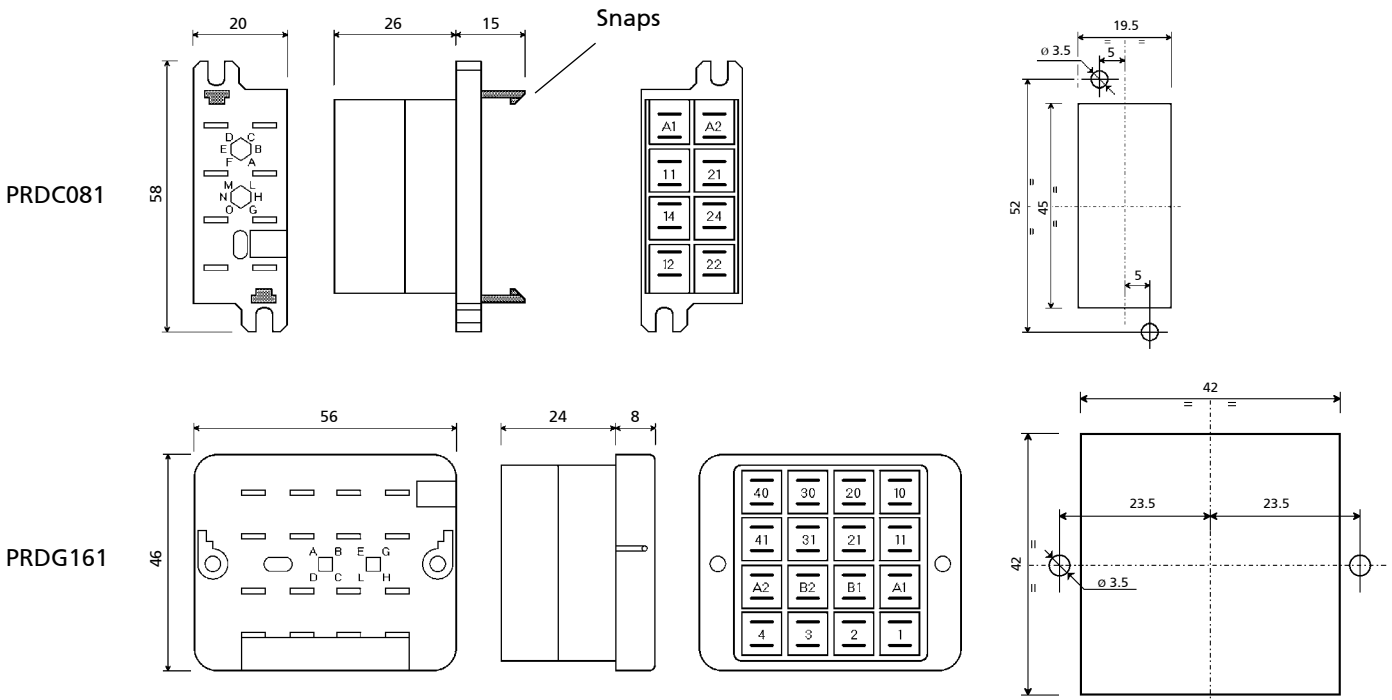

Specifications

Weight: 28 / 69 g
Operating temperature: -25°C...+55°C
Storage temperature: -40°C...+70°C
Panel mounting:
 • ϕ holes: 3.5mm
Degree of protection: IP10
Dielectric strength: 2.5kV 50Hz 1min

Type and size of faston clip: 2 x 4.8 x 0.8
Width of slot: PRDC081 : 7.3 mm
 PRDG161: 7.8 mm
Maximum section of cable: 2 x 2.5 mm²
Fire resistance: EN60695-2-1, UL94 - V0
Standards: EN60255, EN60947, EN 61810

For relays of series: **C, D**
 Terminal type: **SOLDER**
 Mounting: **PCB**

PRCC081
 PRCD161



OVERVIEW

- PCB-mount
- Panel mounting
- Sturdy construction
- No internal soldering
- No maintenance
- Snap-in relay
- Provision for fitment of keying pins



PRCC081



PRCD161



Detail of connections

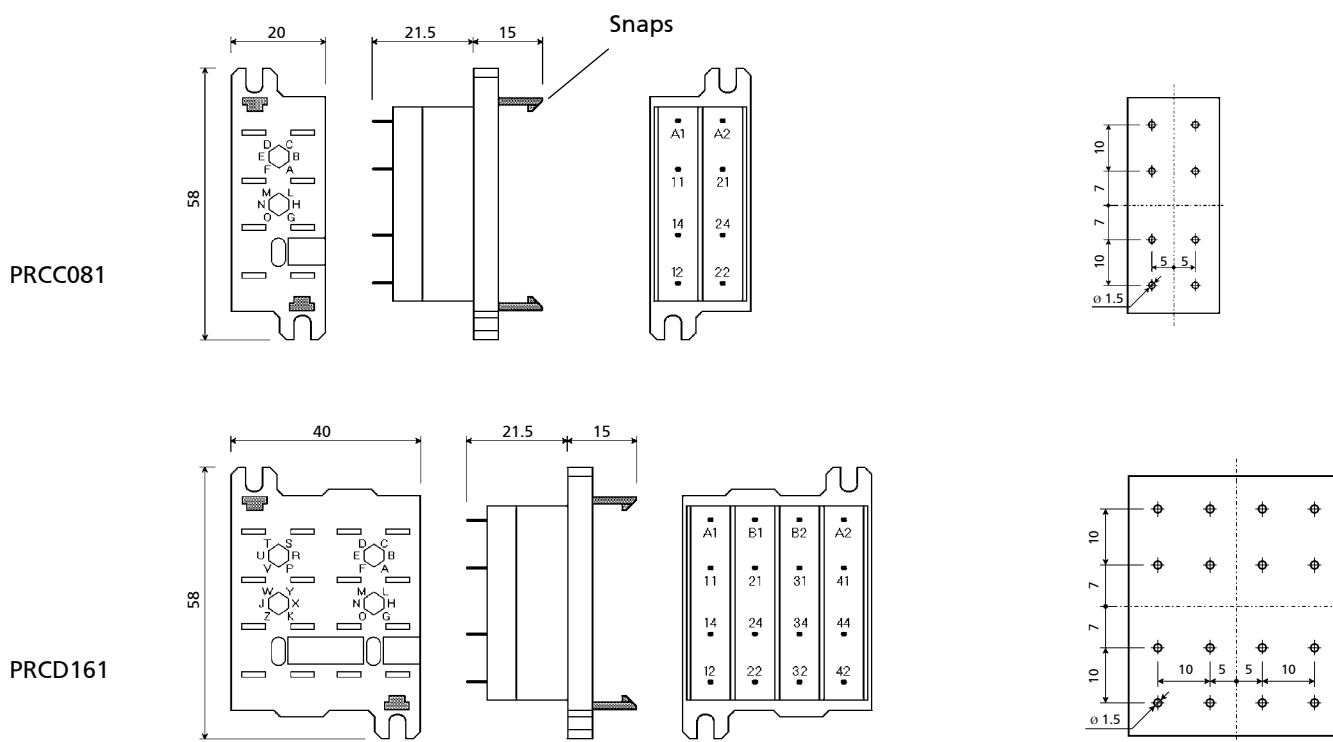

Specifications

Weight: 20 / 36 g

Operating temperature: -25°C...+55°C

Storage temperature: -40°C...+70°C

Dielectric strength: 2.5kV 50Hz 1min

Type and size of terminals: solder, $\phi 1.5$ mm

Fire resistance: EN60695-2-1, UL94 - V0

Standards: EN60255, EN 61810

Numbering correspondence between Relay and Socket

- AMRA relays of the "ENERGY" and "RAILWAY Rolling Stock" series have 2 types of numbering.

Specifications	Models	Example
OK numbering	OK, OKS, OKFC, OKSFC, OKSCD, OKSGcCd, OKUIC, OKBA, TOK, OKTf, OKPh, MOK, UTM	
POK numbering	POK/POKS, BIPOK/BIPOKS, TRIPOK/TRIPOKS, TM, OKT, OKR, RCG, RDG, RGG	

QUADRIPOKS and ESAPOKS models are identified by international numbering.

- Sockets with more than 8 terminals carry both types of numbering (with the exception of the ADF series).

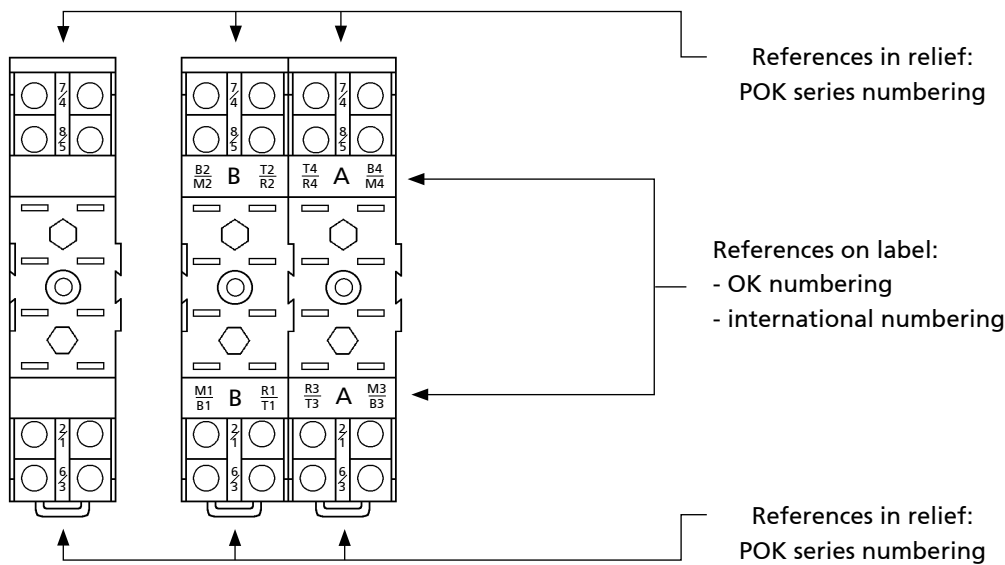

Example of "OK numbering"

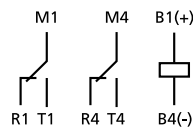

Numbering references; see label

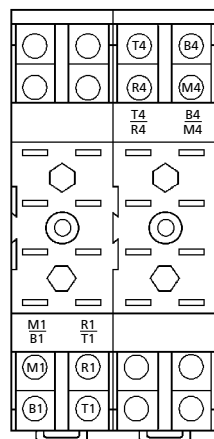

Example of "POK numbering"

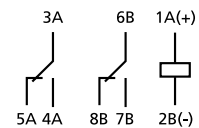

Numbering references; see relief + letter B/A

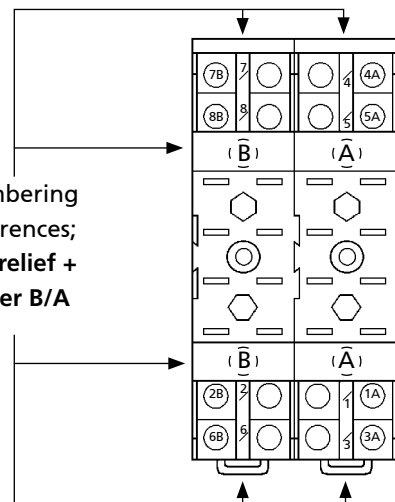

AMRA line - Retaining clips

The designation of retaining clips is made up of two parts:



	1 st part: 2 or 3 letters	2 nd part: 2 numbers
	Identifies the type of relay	Identifies the model of socket
Example	RPB	48

1 st part:	Type of relay	2 nd part:	Socket model
RPB	Relays with cover, height 50mm (POKs, UTM series)	43	53IL, 43IL, 73IL, 65
RQ	Relays with cover, height 61mm (QPOK)	48	PAIR, PRIR, 50IP20-I DIN, 48BIP20-I DIN, 78BIP20-I DIN, 96IP20-I DIN, 156IP20-I DIN, 50L, 48BL, 78BL, 96L ADF1, ADF2, ADF3, ADF4, ADF6 series
RG	Relays with cover, height 86mm (RGG series)		
RC	Relays with cover, height 97mm (OK series)		
RL	Relays with cover, height 109mm (OK series)		
RT	Timer relays with cover, height 97mm	31	PAIR, PRIR, 50IP20-I DIN, 48BIP20-I DIN, 50L, 48BL, ADF1, ADF2 series
RM	Relays with cover, height 118mm (MOK series)		
VM18	Relays RCG, RDG	41	53IL, 43IL, 65

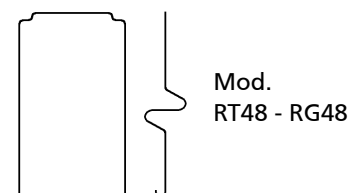
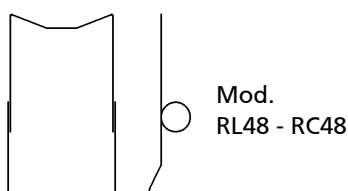
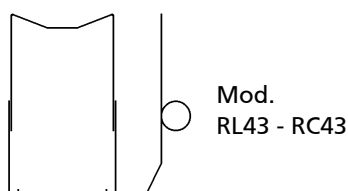
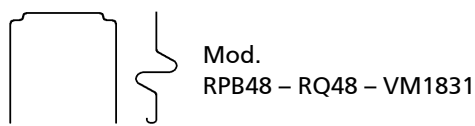

MTI line - Retaining clips

The designation of retaining clips is made up of two parts:



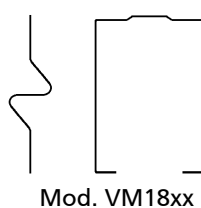
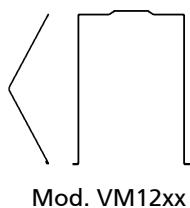

	1 st part: 4 characters	2 nd part: 2 numbers
	Identifies the line	Identifies the relay size
Example	VM12	21

1 st part:	Relay line	2 nd part :	Relay size
VM12	Relays of G line → all RGxx models	21	Relays of 82mm height
		22	Relays of 112mm height
VM18	Relays of C and D line → all RCxx and RDxx models (except RCG, RDG)	21	Relays of 50mm height
		22	Relays of 75mm height
		23	Relays of 82mm height



N.B. Dimensions not to scale. The height of the clip varies according to the height of the relay.
Pack containing 10 pieces.

Positive mechanical keying (polarizing pins)

Relay line	Ordering code	Notes	
AMRA	59	These are supplied in pairs. 1 piece ordered = 2 single pins (Pack containing 25 pairs)	
MTI	VC1705	These are supplied singly. 1 piece ordered = 1 single pin (Pack containing 100 pcs)	

Keying pins are mechanical components of semi-hexagonal shape, designed to prevent a given relay from being plugged into a socket intended for a different component. The keying configuration is determined by fitting the pins both to the relay and to the socket, in positions identified by a dedicated code.

The hexagonal geometry of the receptacle allows the polarizing pins to be inserted in 6 different positions.

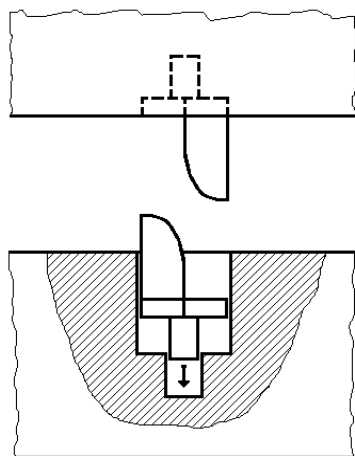

Polarizing pin on relay

Polarizing pin on socket,
to be fitted by the customer

Whilst the use of this component is optional, it is nonetheless strongly recommended where there are multiple relays installed on an electrical panel, for example:

- two or more relays of the same model but with different input voltages
- two or more timer relays with different response and/or logic operating times (e.g. timed to operate on pick-up and timed to operate on drop-out)
- two or more instantaneous relays of different type (e.g. monostable and bistable)

In these cases, the adoption of keying position accessories will prevent any accidental inversion of the relays by the operator, which would risk damage to the system and to the components themselves, as well as jeopardizing safety.

Fitment and position

Relays of standard design are not equipped with these accessories.

The mounting position of polarizing pins, if requested, is determined by the manufacturer.

Keying pins for sockets are fitted normally by the customer.

In this case, keying accessories for application to the socket are ordered separately.

The following relays are supplied with pins fitted in positions determined by the manufacturer:

- STATIONS series, approved by ENEL / TERNA Italia to LV15/LV16/20 specifications
- RAILWAYS - FIXED EQUIPMENT series, approved by RFI (FS Italia Group) to RFI DPRIM STF IFS TE 143 A specification
- RAILWAYS - ROLLING STOCK series

AMRA line

Positions obtainable in hexagonal receptacles

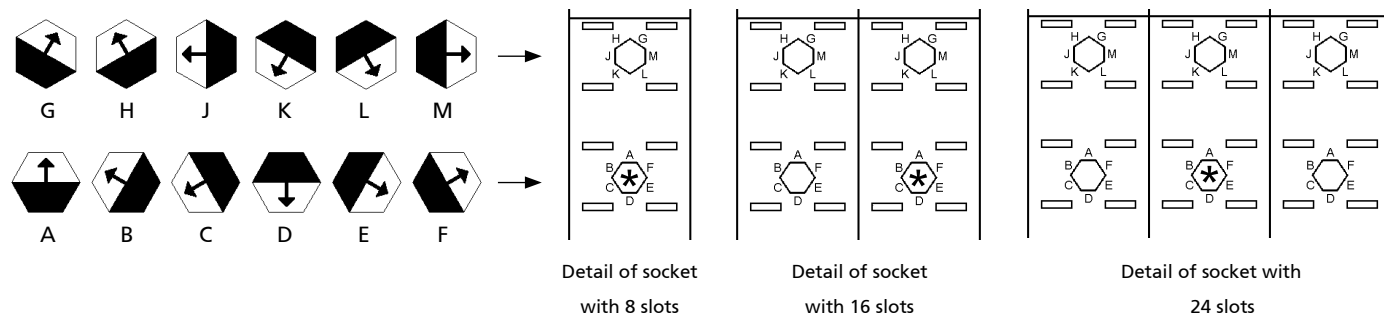

*: receptacle to be left free in the event that the relay is fitted with an antirotation pin.

In the case of polarized input (e.g. with flyback diode), the relay is fitted with an antirotation pin (detail 60). The antirotation pin is always fitted to the following relays:

POK, BIPOK, TRIPOK, QUADRIPOK, ESAPOK, TM, OKTx, OKRx, OKRe-L, CLE, OKRe-Fp.

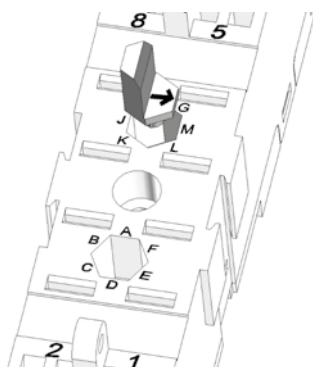

Example of selection, pos. M on socket with 8 slots

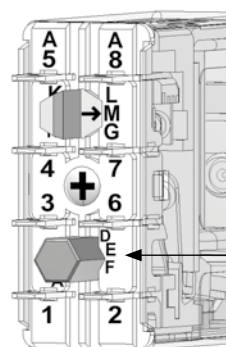

Example of selection, pos. M on POK relay

MTI line

Positions obtainable in hexagonal receptacles

C line

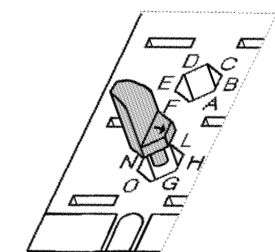
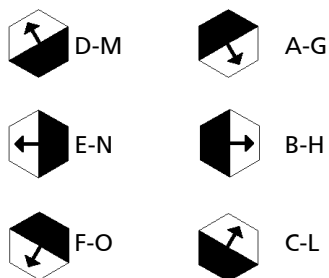

Example of selection, pos. H

2 hexagonal receptacles available on relay and on socket.

D line

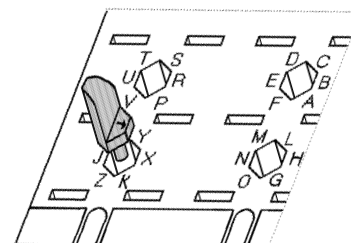
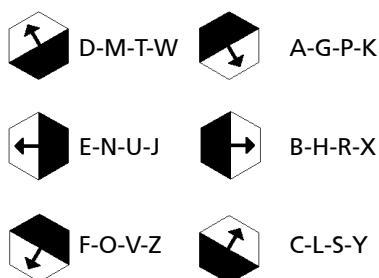

Example of selection, pos. X

4 hexagonal receptacles available on relay and on socket.

Note: all relays are fitted with an antirotation guide pin.

The **CHAUVIN ARNOUX Group**, with its seven brands (AMRA®, CHAUVIN ARNOUX®, METRIX®, MULTIMETRIX®, ENERDIS®, PYROCONTROL®, AEMC®), together with the metrology services provider Manumasure, is a leading European name in measuring and monitoring systems for power grids, electromechanical relays and components for electrical equipment, special temperature sensors and metrology.

CHAUVIN ARNOUX with its two brands, Chauvin Arnoux® and Metrix®, offers a wide range of measuring instruments. These are products designed to meet the measuring needs of the electrical sector (testers, multimeters and current clamps), electrical safety testing, analysis of electrical power and quality (wattmeters and network analysers). The offering also includes items such as oscilloscopes, electronic laboratory equipment and instruments for measuring physical quantities.

Portable testing and measuring instruments



Temperature in industrial processes



Electromechanical relays for demanding applications



Measurement and monitoring of energy consumption

AMRA, the Italian branch of the group, has more than 50 years of experience of designing, manufacturing and marketing electromechanical relays for the most demanding of applications, typically electrical power generation and transmission, railways - rolling stock and fixed equipment - petrochemicals and naval. The AMRA sales network distributes CHAUVIN ARNOUX brand products throughout Italy.

ENERDIS designs measuring instruments for electrical panels and develops smart metering and energy monitoring systems for quantifying consumption.

Ask for the new instruments catalogue



FRANCE - Headquarter



Chauvin Arnoux

190, Rue Championnet - 75876 PARIS Cedex 18
Tel.: (0033) 1 44 85 44 85 - Fax: (0033) 1 46 27 73 89
info@chauvin-arnoux.fr - www.chauvin-arnoux.fr

AUSTRIA

CHAUVIN ARNOUX GES.M.B.H.

Gastgebgsasse 27
1230 WIEN
Tel.: (0043) 1 61 61 9 61
Fax: (0043) 1 61 61 9 61 61
vie-office@chauvin-arnoux.at
www.chauvin-arnoux.at

CHINA

SHANGAI PUJIANG ENERDIS INSTRUMENTS CO. LTD

Building 23 3rd Floor, 1288 Lane
Zhongchun Road Minhang district
Tel.: (0086) 21 65 21 51 96
Fax: (0086) 21 65 21 61 07
info@chauvin-arnoux.com.cn
www.chauvin-arnoux.com.cn

GERMANY

CHAUVIN ARNOUX GMBH

Ohmstrasse, 1
77694 KELH / RHEIN
Tel: (0049) 7851 99 26 0
Fax: (0049) 7851 99 26 60
info@chauvin-arnoux.de
www.chauvin-arnoux.de

UNITED KINGDOM

CHAUVIN ARNOUX LTD

Unit 1 Nelson Court, Flagship
Square Shaw Cross Business Park
Dewsbury West Yorkshire WF12 7TH
Tel.: (0044) 1924 460 494
Fax: (0044) 1924 455 328
info@chauvin-arnoux.co.uk
www.chauvin-arnoux.com

MIDDLE EAST

CHAUVIN ARNOUX MIDDLE EAST

PO Box 60-154
1241 2020 JAL EL DIB
BEIRUT (LIBANO)
Tel.: (00961) 1 890 425
Fax: (00961) 1 890 424
camie@chauvin-arnoux.com

SPAIN

CHAUVIN ARNOUX IBÉRICA S.A.

C/ Roger de Flor N° 293 - 1a Planta
08025 BARCELONA
Tel.: (0034) 902 20 22 26
Fax: (0034) 934 59 14 43
info@chauvin-arnoux.es
www.chauvin-arnoux.es

SWEDEN

CA MÄTSYSTEM AB

PO Box NR 4501
SE 18362 TÄBY
Tel.: (0046) 8 50 52 68 00
Fax: (0046) 8 50 52 68 10
info@camatsystem.com
www.camatsystem.com

SWITZERLAND

CHAUVIN ARNOUX AG

Moosacherstrasse 15
CH 8804 AU / ZH
Tel: (0041) 44 727 75 55
Fax: (0041) 44 727 75 56
info@chauvin-arnoux.ch
www.chauvin-arnoux.ch

USA

**CHAUVIN ARNOUX INC
d.b.a. AEMC Instruments**

200 Foxborough blvd
foxborough - MA 02035
Tel.: (001) 508 698 2115
Fax: (001) 508 698 2118
sales@aemc.com
www.aemc.com



AMRA S.p.A. - Chauvin Arnoux Group

Via Sant'Ambrogio, 23/25 - 20846 MACHERIO (MB) - ITALIA
Tel. +39 039 2457545
E-mail: info@amra-chauvin-arnoux.it
Web: www.amra-chauvin-arnoux.it

